

**T**eknik Makina 1987 yılında otomotiv sektöründe imalat hayatına başlamıştır. Bir süre bu sektörde hizmet verdikten sonra 1994'te sektör değiştirerek, kesici takımlar imalatına adım atmıştır. Yaklaşık 5000'i aşkın ürün çeşidi ile geniş bir üretime sahiptir. Kurulduğundan bu güne kadar performans, kalite ve maliyet olarak en iyi ürünlerle hizmet vermeye devam etmektedir.

Kuruluşundan bu yana yüksek teknolojiye , yeniliklere, yeni projelere açık olup kendisini sürekli yenilemektedir.

Ürünlerinin ve hizmetinin kalitesini arttırarak ISO9001:2008 belgesini almış; müşterilerinin var olan güvenini daha da pekiştirmiştir. Kısa ve uzun vadeli oluşturulmuş kalkınma plânlarıyla yıllık üretim adetlerini yükseltmeyi hedefleyen TEKNİK MAKİNA konusunda uzman çalışanları ile ilk günkü heyecan ve istekle çalışmalarını sürdürerek Dünya ve Türkiye pazarındaki yerini daha da sağlamlaştırarak yükselen grafiğini aynı istikrarda yürütmeye ve ülke ekonomisine katkılarını sürdürmekte kararlıdır.



Technical solution for quality

Kalite için TEKNİK Çözüm

**T**eknik Cutting tools has been established in 1987 in Turkey. Teknik Cutting Tools started to produce cutting tools in 1994. Over 5.000 kinds of tools are produced in the factory building located in the Fourth Industrial Area of Konya since 2015. Teknik Cutting Tools is a very experienced producer for a large range of a Cutting Tools: Face Mills, End Mills, Boring Bars, External Turning Holders and more. There are 40 production lines which are capable to produce in several categories at the same time.

We keep up to date with new products and when customers need special tools we do all we can to produce the tools to meet their expectations.

Production and designing teams are all educated and certified according to the ISO 9001:2008 quality standard to serve you better.

The Company Headquarters is also located in Konya.

Konya and Istanbul branches are dedicated with marketing and sales. Teknik Cutting Tools does international trade as cutting tools exporter with many countries all around the World and offers the highest level of quality, service and reliability, in a very short lead-time with the best price, guaranteed.



İbrar Alattı Sanctı, Tırışkırı ve Faltısarı  
66700666 - 66700666  
İbrar Alattı Sanctı, Tırışkırı ve Faltısarı, M. İbrar Alattı, İbrar Alattı Sanctı, Tırışkırı ve Faltısarı, 15



**BORING TOOLS**

**AUSDREHWERKZEUGE FÜR DIE FERTIGBEARBEITUNG**

**FACE MILL**

**ECKMESSERKOPF**

**SHOULDER MILLER**

**IGELFRÄSER**

**END MILL**

**SCHAFTFRÄSER**

**U-DRILL**

**VOLLBOHRER**

**SCREW ON SHOULD MILLING CUTTERS**

**EINSCHRAUB-FRÄSER**



**تکنیک تولز**  
ابزار آلات صنعتی، تراشکاری و ماشینکاری

۶۶۷۱۱۷۲۹ - ۶۶۷۱۱۹۶۷

تهران، خ امام خمینی، م حسن آباد، پاساژ هشت گنبد، شماره ۱۵

[www.teknikcuttingtools.com](http://www.teknikcuttingtools.com)

# Kalite için **TEKNİK Çözüm**

Technical solution for quality



**GROOVING TOOLS**

**STECH-KLEMMHALTER**

**THREADING TOOL HOLDERS**

**GEWINDE BOHRSTANGEN**

**EXTERNAL TURNING HOLDERS**

**KLEMMDREHHALTER**

**INTERNAL TURNING HOLDERS**

**BOHRSTANGEN**

**TOOL HOLDERS**

**WERKZEUGAUFNAHMEN**

**SPECIAL TOOLS**







**SPEZIALWERKZEUGE**

**تکنیک تولز**

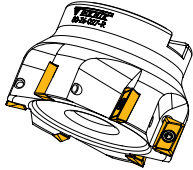
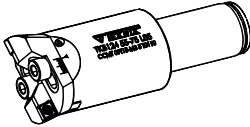
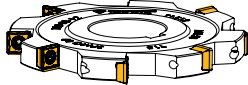
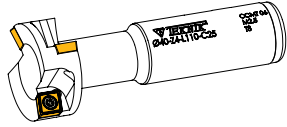
ابزار آلات صنعتی، تراشکاری و ماشینکاری

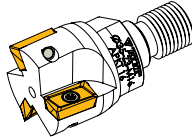
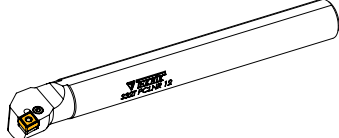
۶۶۷۱۱۷۲۹ - ۶۶۷۱۱۹۶۷

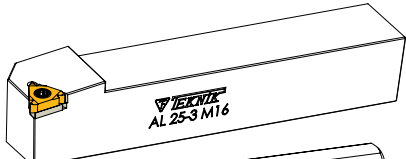
تهران، خ امام خمینی، م حسن آباد، پاساژ هشت گنبد، شماره ۱۵

S./P.	Ürün Türü / Product Type / Produktart	
7-30	<b>Trama Başlığı</b>	
	Face Mill	
	Eckmesserkopf-Rundplattenfräser	
32-43	<b>Baralar</b>	
	Borings	
	Ausdrehwerkzeug	
45-49	<b>Helis Freze - Disk Freze</b>	
	Shoulder Miller - Disc Milling	
	Igelfräser - Scheibenfräsen	
51-58	<b>T Kanal Freze</b>	
	T-Slot Milling Cutter	
	T- Nutenfräser	
60-83	<b>Saplı Tarama - Küre Uçlu Freze</b>	
	End Mill - Radius Cutter - Schafffräser	
	Küre Uçlu Freze - Radius Cutter - Kugelfräser	
85-90	<b>Vidalı Takım</b>	
	Screw Head	
	Einschraubfräser	
92-99	<b>P Sistem Kater</b>	
	P System Turning Holder	
	P System Drehhalter	
100-103	<b>A Sistem Kater</b>	
	A System Turning Holder	
	A System Drehhalter	
105-129	<b>D-M-C Sistem Kater</b>	
	D-M-C System Turning Holder	
	D-M-C System Drehhalter	
131-134	<b>Diş Katerleri</b>	
	Threading Holders	
	Klemmhalter (Außengewinde)	

S./P.	Ürün Türü / Product Type / Produktart
136-161	<b>S Sistem Kater</b>
	<i>S System Turning Holder</i>
	<i>S System Drehhalter</i>
163-164	<b>İç Çap Kater Set</b>
	<i>Boring Bars Sets</i>
	<i>Bohrstangen Sets</i>
166-172	<b>İç Çap Kater İçten Soğutmalı</b>
	<i>Boring Bars (Cooled)</i>
	<i>Bohrstange (mit Innenkühlung)</i>
174-185	<b>U-DRILL</b>
	<i>Indexable Insert Drills</i>
	<i>Vollbohrer</i>
187-201	<b>Kanal Katerler</b>
	<i>Grooving Holder</i>
	<i>Stech-Klemmhalter</i>
202	<b>Mini Kanal Kater-Diş Açma Freze</b>
	<i>Mini Grooving Holders - Thread Cutting Cutter</i>
	<i>Stech-Mini Klemmhalter - Gewindeschneid Fräser</i>
203	<b>Keski Kütüğü</b>
	<i>Block For Blades</i>
	<i>Grundhalter für Stechleisten</i>
205-206	<b>Takım Tutucuları</b>
	<i>Tool Holder</i>
	<i>Werkzeugaufnahmen</i>
208-211	<b>Yedek Parça</b>
	<i>Spare Parts</i>
	<i>Zubehör</i>
212-219	<b>Kesme Verileri - ISO Kodları</b>
	<i>Cutting DaTA- ISO Code</i>
	<i>Schnittdaten - ISO Code</i>

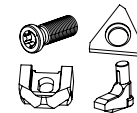
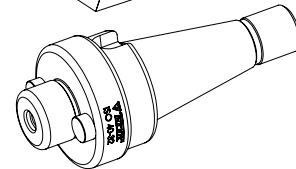
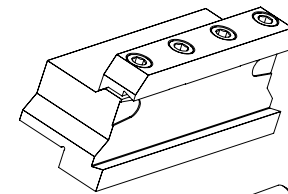
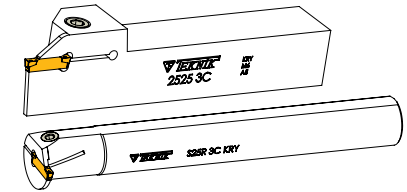
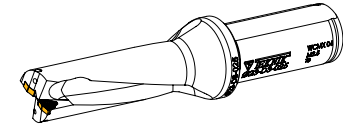
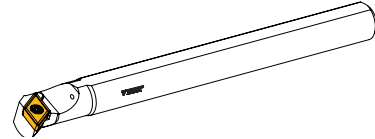
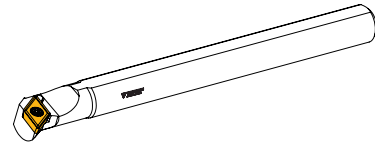



## Tarama Başlıkları

Milling Tools

Eckmesserkopf



Planmesserkopf

Rundplattenfräser

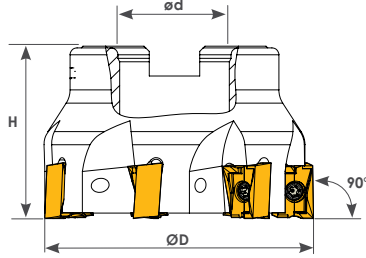
## T1 90° LNMX 1510

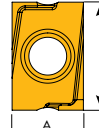

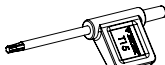

Ölçüler (mm) Dimensions (mm) Abmessungen (mm)			LNMX 1510	
L	S	A		
15	10	10	S	A

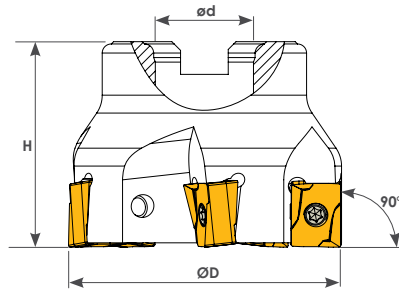

Sipariş Kodu Order Code Best.-Nr.	Stok/Stock/Lager	Ürün Kodu Product Code Produkt-Code	Ölçüler (mm) Dimensions (mm) Abmessungen (mm)				Kullanılan Uç Insert WSP	Sıkma Cıvatası Clamp Screw Torx-Schraube	Anahtar Torx Key Torx-Schlüssel
			ØD	ød	Z	H			
T372	●	D050 d22 Z04 LN--15	50	22	4	45			
T374	●	D063 d22 Z06 LN--15	63	22	6	45			
T376	●	D080 d27 Z07 LN--15	80	27	7	50			
T378	●	D100 d32 Z08 LN--15	100	32	8	52			
T380	●	D125 d40 Z10 LN--15	125	40	10	63			

KRLY ucuna uygundur. / Compatible with KRLY insert. / Kompatible für KRLY WP

## T2 90° LNGX 1307

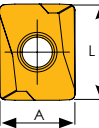

Ölçüler (mm) Dimensions (mm) Abmessungen (mm)			LNGX 1307	
A	L	S		
11	14	7,74	S	A

Sipariş Kodu Order Code Best.-Nr.	Stok/Stock/Lager	Ürün Kodu Product Code Produkt-Code	Ölçüler (mm) Dimensions (mm) Abmessungen (mm)				Kullanılan Uç Insert WSP	Sıkma Cıvatası Clamp Screw Torx-Schraube	Anahtar Torx Key Torx-Schlüssel
			ØD	ød	Z	H			
T488	●	D040 d16 Z03 LN--13	40	16	3	45			
T490	●	D050 d22 Z04 LN--13	50	22	4	45			
T492	●	D063 d22 Z06 LN--13	63	22	6	45			
T493	●	D080 d27 Z07 LN--13	80	27	7	50			
T494	●	D100 d32 Z07 LN--13	100	32	7	50			
T495	●	D125 d40 Z08 LN--13	125	40	8	63			

● Stokta/ In Stock / Lager ○ Sınırlı Stok / Limited Stock / Begrenzte Lagerhaltung  
WLTR ucuna uygundur. / Compatible with WLTR insert. / Kompatible für WLTR WP

**T3**  
**90° ANKX 1205**

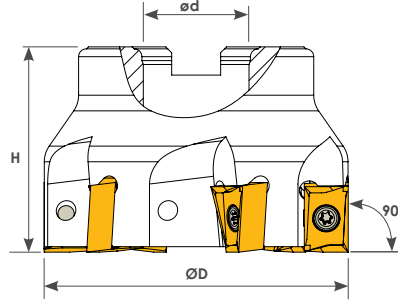

Ölçüler (mm) Dimensions (mm) Abmessungen (mm)			ANKX 1205	
L	S	A		
13,7	9,15	9,7	A	S

Sipariş Kodu Order Code Best.-Nr.	Stok/Stock/Lager	Ürün Kodu Product Code Produkt-Code	Ölçüler (mm) Dimensions (mm) Abmessungen (mm)				Kullanılan Uç Insert WSP	Sıkma Civatası Clamp Screw Torx-Schraube	Anahtar Torx Key Torx-Schlüssel
			ØD	ød	Z	H			
T572	●	D050 d22 Z05 AN--12	50	22	5	45	ANKX 1205 ISCR	TC077 M4x10	T15
T574	●	D063 d22 Z06 AN--12	63	22	6	45			
T576	●	D080 d27 Z07 AN--12	80	27	7	50			

ISCR ucuna uygundur. / Compatible with ISCR insert. / Kompatible für ISCR WP

**T4**  
**90° ANKX 1710**

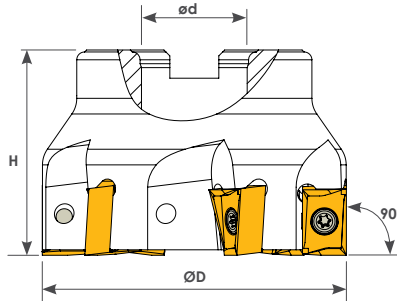

Ölçüler (mm) Dimensions (mm) Abmessungen (mm)			ANKX 1710	
L	S	A		
16,7	10,4	11,2	A	S

Sipariş Kodu Order Code Best.-Nr.	Stok/Stock/Lager	Ürün Kodu Product Code Produkt-Code	Ölçüler (mm) Dimensions (mm) Abmessungen (mm)				Kullanılan Uç Insert WSP	Sıkma Civatası Clamp Screw Torx-Schraube	Anahtar Torx Key Torx-Schlüssel
			ØD	ød	Z	H			
T440	●	D040 d16 Z03 AN--17	40	16	3	45	ANKX 1710 ISCR	TC085 M5x12	T20
T442	●	D050 d22 Z04 AN--17	50	22	4	45			
T444	●	D063 d22 Z05 AN--17	63	22	5	45			
T446	●	D080 d27 Z06 AN--17	80	27	6	52			
T448	●	D100 d32 Z07 AN--17	100	32	7	52			
T450	●	D125 d40 Z08 AN--17	125	40	8	63			

● Stokta / In Stock / Lager ○ Sınırlı Stok / Limited Stock / Begrenzte Lagerhaltung  
ISCR ucuna uygundur. / Compatible with ISCR insert. / Kompatible für ISCR WP

**تکنیک تولز**  
ایران لات صنعتی، تراشکاری و قالبسازی  
۶۶۷۱۱۶۷ - ۶۶۷۱۱۶۹  
تهران، خ امام خمینی، م حسن آباد، پاساژ هشت گنبد، شماره ۱۵



## T5 90° LNGU 15T6

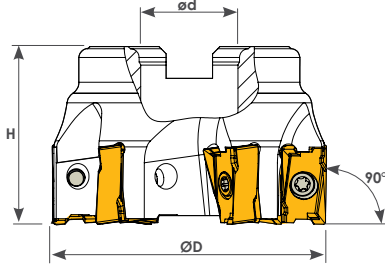

Ölçüler (mm) Dimensions (mm) Abmessungen (mm)			LNGU 15T6	
L	S	A		
17	6,96	10		

Sipariş Kodu Order Code Best.-Nr.	Stok/Stock/Lager	Ürün Kodu Product Code Produkt-Code	Ölçüler (mm) Dimensions (mm) Abmessungen (mm)				Kullanılan Uç Insert WSP	Sıkma Cıvatası Clamp Screw Torx-Schraube	Anahtar Torx Key Torx-Schlüssel
			ØD	ød	Z	H			
T956	●	D050 d22 Z05 LN--15	50	22	5	40	LNGU 15T6 KNNMTL	TC076 M4x12,5	T15
T958	●	D063 d22 Z06 LN--15	63	22	6	40			
T960	●	D080 d27 Z07 LN--15	80	27	7	50			
T961	●	D100 d32 Z08 LN--15	100	32	8	50			

KNNMTL ucuna uygundur. / Compatible with KNNMTL insert. / Kompatible für KNNMTL WP

## T6 3PKT 1505

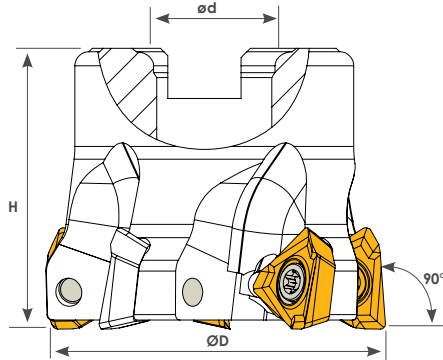

Ölçüler (mm) Dimensions (mm) Abmessungen (mm)			3PKT 1505	
d	l	s		
10,7	11	5		

Sipariş Kodu Order Code Best.-Nr.	Stok/Stock/Lager	Ürün Kodu Product Code Produkt-Code	Ölçüler (mm) Dimensions (mm) Abmessungen (mm)				Kullanılan Uç Insert WSP	Sıkma Cıvatası Clamp Screw Torx-Schraube	Anahtar Torx Key Torx-Schlüssel
			ØD	ød	Z	H			
T398	●	D050 d22 Z05-3P--15	50	22	5	40	3PKT 1505 TGTC	TC074 M4x10	T15
T399	●	D063 d22 Z06-3P--15	63	22	6	40			
T400	●	D080 d27 Z07-3P--15	80	27	7	50			

● Stokta/ In Stock / Lager ○ Sınırlı Stok / Limited Stock / Begrenzte Lagerhaltung  
TGTCucuna uygundur. / Compatible with TGTCinsert. / Kompatible für TGTCWP

**T7**  
**90° LNMX 1006**

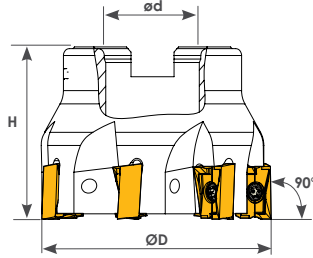

Ölçüler (mm) Dimensions (mm) Abmessungen (mm)			LNMX 1006	
L	S	A		
10	6,5	6,35		

Sipariş Kodu Order Code Best.-Nr.	Stok/Stock/Lager	Ürün Kodu Product Code Produkt-Code	Ölçüler (mm) Dimensions (mm) Abmessungen (mm)				Kullanılan Uç Insert WSP	Sıkma Civatası Clamp Screw Torx-Schraube	Anahtar Torx Key Torx-Schlüssel
			ØD	ød	Z	H			
T386	●	D040 d16 Z05 LN--10	40	16	5	40	LN-- 1006 KRLY	TC065 M3x7	T8
T387	●	D050 d22 Z06 LN--10	50	22	6	45			
T388	●	D063 d22 Z06 LN--10	63	22	6	45			
T389	●	D080 d27 Z07 LN--10	80	27	7	50			

KRLY ucuna uygundur. / Compatible with KRLY insert. / Kompatible für KRLY WP

**T8**  
**45° SNKX 1206**

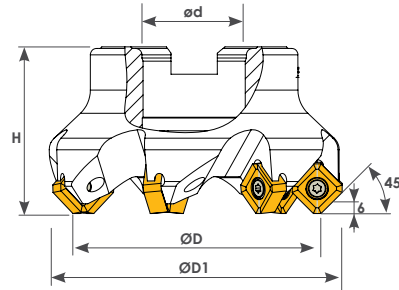

Ölçüler (mm) Dimensions (mm) Abmessungen (mm)				SNKX 1206	
L	S	a	d1		
12,7	6,35	2,36	4,5		

Sipariş Kodu Order Code Best.-Nr.	Stok/Stock/Lager	Ürün Kodu Product Code Produkt-Code	Ölçüler (mm) Dimensions (mm) Abmessungen (mm)					Kullanılan Uç Insert WSP	Sıkma Civatası Clamp Screw Torx-Schraube	Anahtar Torx Key Torx-Schlüssel
			ØD	ØD1	ød	Z	H			
T320	●	D050 d22 Z04 SN--12	50	63	22	4	44	SN-- 1206 KRLY	TC076 M4x12,5	T15
T322	●	D063 d22 Z06 SN--12	63	76	22	6	44			
T325	●	D080 d27 Z07 SN--12	80	93	27	7	52			
T330	●	D100 d32 Z08 SN--12	100	113	32	8	52			
T332	●	D125 d40 Z10 SN--12	125	138	40	10	63			
T334	●	D160 d40 Z12 SN--12	160	173	40	12	63			
T335	●	D200 d60 Z14 SN--12	200	213	60	14	63			

● Stokta / In Stock / Lager ○ Sınırlı Stok / Limited Stock / Begrenzte Lagerhaltung  
KRLY ucuna uygundur. / Compatible with KRLY insert. / Kompatible für KRLY WP

## T9 90° XNEX 0806

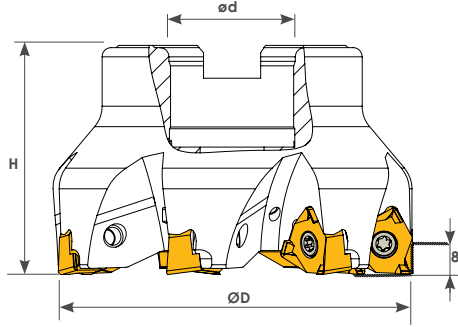

Ölçüler (mm) Dimensions (mm) Abmessungen (mm)			XNEX 0806	
d	l	s		
12,48	8	6,47		

Sipariş Kodu Order Code Best.-Nr.	Stok/Stock/Lager	Ürün Kodu Product Code Produkt-Code	Ölçüler (mm) Dimensions (mm) Abmessungen (mm)				Kullanılan Uç Insert WSP	Sıkma Cıvatası Clamp Screw Torx-Schraube	Anahtar Torx Key Torx-Schlüssel
			ØD	ød	Z	H			
T840	●	D050 d22 Z04 XN--08	50	22	4	45	XNEX 0806 SCO	TC076 M4x12,5	T15
T842	●	D063 d22 Z06 XN--08	63	22	6	45			
T844	●	D080 d27 Z07 XN--08	80	27	7	50			
T846	●	D100 d32 Z07 XN--08	100	32	7	52			
T848	●	D125 d40 Z10 XN--08	125	40	10	60			
T850	●	D160 d40 Z12 XN--08	160	40	12	63			
T851	●	D200 d60 Z14 XN--08	200	60	14	63			

SCO ucuna uygundur. / Compatible with SCO insert. / Kompatible für SCO WP

## T10 90° XNKT 0805

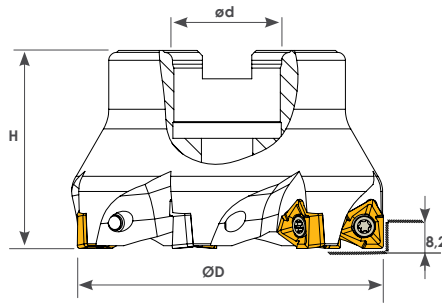

Ölçüler (mm) Dimensions (mm) Abmessungen (mm)			XNKT 0805	
d	l	s		
10	8,2	5,5		

**تکنیک تولز**  
ابزار آلات صنعتی، تراشکاری و ماشینکاری  
۶۶۷۱۱۶۶۷ - ۶۶۷۱۱۷۳۹  
تهران، خ امام خمینی، م حسن آباد، پاساژ هشت گنبد، شماره ۱۵

Sipariş Kodu Order Code Best.-Nr.	Stok/Stock/Lager	Ürün Kodu Product Code Produkt-Code	Ölçüler (mm) Dimensions (mm) Abmessungen (mm)				Kullanılan Uç Insert WSP	Sıkma Cıvatası Clamp Screw Torx-Schraube	Anahtar Torx Key Torx-Schlüssel
			ØD	ød	Z	H			
T900	●	D040 d16 Z04 XN--08	40	16	4	45	XNKT 0805 KRLY	TC074 M4x10	T15
T902	●	D050 d22 Z05 XN--08	50	22	5	45			
T904	●	D063 d22 Z06 XN--08	63	22	6	45			
T906	●	D080 d27 Z07 XN--08	80	27	7	50			

● Stokta/ In Stock / Lager ○ Sınırlı Stok / Limited Stock / Begrenzte Lagerhaltung  
KRLY ucuna uygundur. / Compatible with KRLY insert. / Kompatible für KRLY WP

## T11 88° SNMX 1206

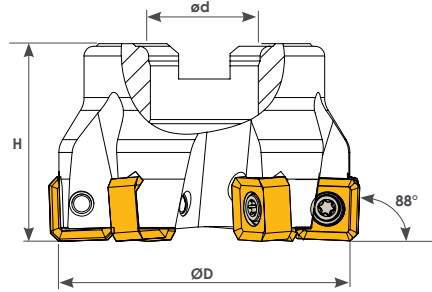

Ölçüler (mm) Dimensions(mm) Abmessungen (mm)				SNMX 1206	
L	S	r	d1		
12,7	6,35	0,80	4,5		

Sipariş Kodu Order Code Best.-Nr.	Stok/Stock/Lager	Ürün Kodu Product Code Produkt-Code	Ölçüler (mm) Dimensions(mm) Abmessungen (mm)				Kullanılan Uç Insert WSP	Sıkma Civatası Clamp Screw Torx-Schraube	Anahtar Torx Key Torx-Schlüssel
			ØD	ød	Z	H			
T344	●	D063 d22 Z06 SN--12	63	22	6	40	SNMX 1206 KRLY	TC076 M4x12,5	T15
T345	●	D080 d27 Z07 SN--12	80	27	7	50			
T346	●	D100 d32 Z08 SN--12	100	32	8	50			

KRLY ucuna uygundur. / Compatible with KRLY insert. / Kompatible für KRLY WP

## T12 55° HNHX 1006

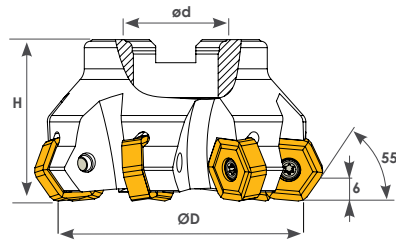

Ölçüler (mm) Dimensions(mm) Abmessungen (mm)			HNHX 1006	
l	d	s		
10	19,05	6,35		

Sipariş Kodu Order Code Best.-Nr.	Stok/Stock/Lager	Ürün Kodu Product Code Produkt-Code	Ölçüler (mm) Dimensions(mm) Abmessungen (mm)				Kullanılan Uç Insert WSP	Sıkma Civatası Clamp Screw Torx-Schraube	Anahtar Torx Key Torx-Schlüssel
			ØD	ød	Z	H			
T470	●	D063 d22 Z05 HN--10	63	22	5	50	HNHX 1006 TGTC	TC083 M5x12	T20
T472	●	D080 d27 Z07 HN--10	80	27	7	50			
T474	●	D100 d32 Z09 HN--10	100	32	9	62			
T476	●	D125 d40 Z10 HN--10	125	40	10	62			
T478	●	D160 d40 Z12 HN--10	160	40	12	62			

● Stokta/ In Stock / Lager ○ Sınırlı Stok / Limited Stock / Begrenzte Lagerhaltung  
TGTC ucuna uygundur. / Compatible with TGTCinsert. / Kompatible für TGTCWP



## T13 45° ONMX 0806

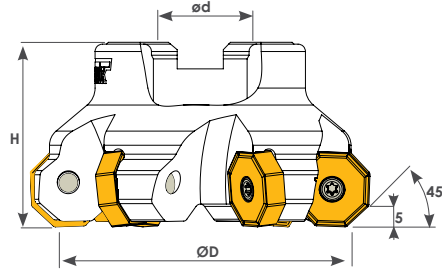

Ölçüler (mm) Dimensions (mm) Abmessungen (mm)			ONMX 0806	
l	d	S		
8,4	20,2	6		

Sipariş Kodu Order Code Best.-Nr.	Stok/Stock/Lager	Ürün Kodu Product Code Produkt-Code	Ölçüler (mm) Dimensions (mm) Abmessungen (mm)				Kullanılan Uç Insert WSP	Sıkma Civatası Clamp Screw Torx-Schraube	Anahtar Torx Key Torx-Schlüssel
			ØD	ød	Z	H			
T780	●	D063 d22 Z05 ON--08	63	22	5	40	ONMX 0806 KRLY	TC084 M5x13	T20
T782	●	D080 d27 Z06 ON--08	80	27	6	50			
T784	●	D100 d32 Z07 ON--08	100	32	7	50			
T786	●	D125 d40 Z08 ON--08	125	40	8	63			

KRLY ucuna uygundur. / Compatible with KRLY insert. / Kompatible für KRLY WP

## T14 45° ONMX 0606

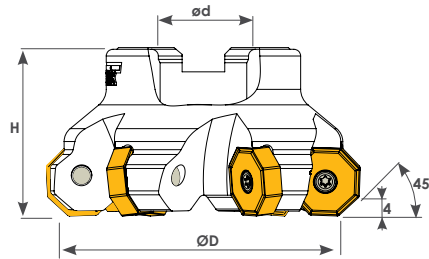

Ölçüler (mm) Dimensions (mm) Abmessungen (mm)			ONMX 0606	
l	d	S		
6,6	16	6		



Sipariş Kodu Order Code Best.-Nr.	Stok/Stock/Lager	Ürün Kodu Product Code Produkt-Code	Ölçüler (mm) Dimensions (mm) Abmessungen (mm)				Kullanılan Uç Insert WSP	Sıkma Civatası Clamp Screw Torx-Schraube	Anahtar Torx Key Torx-Schlüssel
			ØD	ød	Z	H			
T790	●	D063 d22 Z05 ON--06	63	22	5	45	ONMX 0606 KRLY	TC083 M5x12	T20
T791	●	D080 d27 Z06 ON--06	80	27	6	50			
T792	●	D100 d32 Z07 ON--06	100	32	7	50			

● Stokta / In Stock / Lager ○ Sınırlı Stok / Limited Stock / Begrenzte Lagerhaltung  
KRLY ucuna uygundur. / Compatible with KRLY insert. / Kompatible für KRLY WP

**T16**  
**45° ONMU 0505**

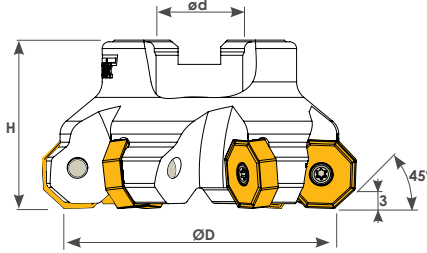

Ölçüler (mm) Dimensions(mm) Abmessungen (mm)			ONMU 0505	
I	d	S		
5	13	5,20		

Sipariş Kodu Order Code Best.-Nr.	Stok/Stock/Lager	Ürün Kodu Product Code Produkt-Code	Ölçüler (mm) Dimensions(mm) Abmessungen (mm)				Kullanılan Uç Insert WSP	Sıkma Civatası Clamp Screw Torx-Schraube	Anahtar Torx Key Torx-Schlüssel
			ØD	ød	Z	H			
T794	●	D063 d22 Z06 ON--05	63	22	6	45	ONMU 0505 ISCR	TC085 M5x12	T20
T796	●	D080 d27 Z07 ON--05	80	27	7	52			
T798	●	D100 d32 Z08 ON--05	100	32	8	52			
T800	●	D125 d40 Z10 ON--05	125	40	10	62			
T801	●	D160 d40 Z12 ON--05	160	40	12	62			

ISCR ucuna uygundur. / Compatible with ISCR insert. / Kompatible für ISCR WP

**T18**  
**43° OFCR 0704**

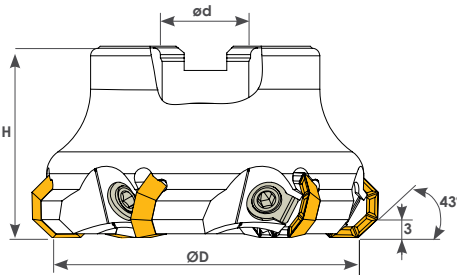

Ölçüler (mm) Dimensions(mm) Abmessungen (mm)			OFCR 0704	
I	L	S		
7	18	4,97		

Sipariş Kodu Order Code Best.-Nr.	Stok/Stock/Lager	Ürün Kodu Product Code Produkt-Code	Ölçüler (mm) Dimensions(mm) Abmessungen (mm)				Kullanılan Uç Insert WSP	Baskı Kepi Clamp Spann pratze	Sıkma Civatası Clamp Screw Inbuss-Schraube	Anahtar Allen Key Inbusschlüssel
			ØD	ød	Z	H				
T260	●	D050 d22 Z04 OF--07	50	22	4	45	OFCR 0704 ISO	BK300	TC300 M8x18	4 Allen
T262	●	D063 d22 Z04 OF--07	63	22	4	45				
T264	●	D080 d27 Z06 OF--07	80	27	6	50				
T266	●	D100 d32 Z08 OF--07	100	32	8	50				
T268	●	D125 d40 Z09 OF--07	125	40	9	62				

● Stokta/ In Stock / Lager ○ Sınırlı Stok / Limited Stock / Begrenzte Lagerhaltung  
43° OFCR 0704 ISO'dur. / 43° OFCR 0704 is ISO. / Kompatible für ISO WP

## T20 90° XOMX 1806

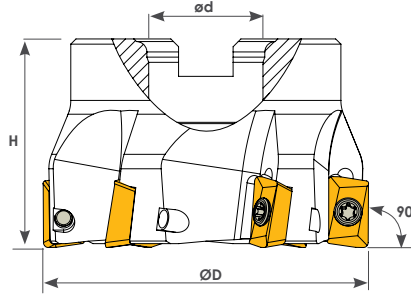

Ölçüler (mm) Dimensions (mm) Abmessungen (mm)		XOMX 1806	
L	S		
17,5	6,35		

Sipariş Kodu Order Code Best.-Nr.	Stok/Stock/Lager	Ürün Kodu Product Code Produkt-Code	Ölçüler (mm) Dimensions (mm) Abmessungen (mm)				Kullanılan Uç Insert WSP	Sıkma Cıvatası Clamp Screw Torx-Schraube	Anahtar Torx Key Torx-Schlüssel
			ØD	ød	Z	H			
T520	●	D050 d22 Z05 XO--18	50	22	5	45	XOMX 1806 SCO	TC080 M4,5x11	T15
T522	●	D063 d22 Z06 XO--18	63	22	6	45			
T524	●	D080 d27 Z07 XO--18	80	27	7	50			
T525	●	D100 d32 Z08 XO--18	100	32	8	52			
T526	●	D125 d40 Z09 XO--18	125	40	9	62			
T527	●	D160 d40 Z10 XO--18	160	40	10	62			

SCO ucuna uygundur. / Compatible with SCO insert. / Kompatible für SCO WP

## T22 90° XOMX 1204

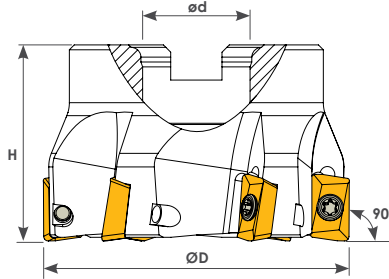

Ölçüler (mm) Dimensions (mm) Abmessungen (mm)		XOMX 1204	
L	S		
11,73-12,16	5,06		



Sipariş Kodu Order Code Best.-Nr.	Stok/Stock/Lager	Ürün Kodu Product Code Produkt-Code	Ölçüler (mm) Dimensions (mm) Abmessungen (mm)				Kullanılan Uç Insert WSP	Sıkma Cıvatası Clamp Screw Torx-Schraube	Anahtar Torx Key Torx-Schlüssel
			ØD	ød	Z	H			
T510	●	D040 d16 Z04 XO--12	40	16	4	40	XOMX 1204 SCO	TC069 M3,5x8,5	T10
T512	●	D050 d22 Z05 XO--12	50	22	5	40			
T514	●	D063 d22 Z06 XO--12	63	22	6	40			
T516	●	D080 d27 Z07 XO--12	80	27	7	50			
T518	●	D100 d32 Z10 XO--12	100	32	10	52			
T519	●	D125 d40 Z12 XO--12	125	40	12	62			

● Stokta/ In Stock / Lager ○ Sınırlı Stok / Limited Stock / Begrenzte Lagerhaltung  
SCO ucuna uygundur. / Compatible with SCO insert. / Kompatible für SCO WP

## T24 90° APKT 1806

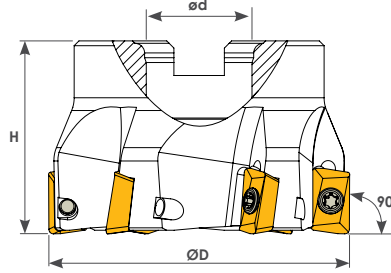

Ölçüler (mm) Dimensions(mm) Abmessungen (mm)		APKT 1806	
L	S		
18	6,33		

Sipariş Kodu Order Code Best.-Nr.	Stok/Stock/Lager	Ürün Kodu Product Code Produkt-Code	Ölçüler (mm) Dimensions(mm) Abmessungen (mm)				Kullanılan Uç Insert WSP	Sıkma Civatası Clamp Screw Torx-Schraube	Anahtar Torx Key Torx-Schlüssel
			ØD	ød	Z	H			
T424	●	D063 d22 Z05 AP--18	63	22	5	45	APKT 1806 R390 SNDVK	TC074 M4x10	T15
T426	●	D080 d27 Z06 AP--18	80	27	6	52			
T428	●	D100 d32 Z07 AP--18	100	32	7	52			
T430	●	D125 d40 Z08 AP--18	125	40	8	62			
T432	●	D160 d40 Z10 AP--18	160	40	10	62			

SNDVK ucuna uygundur. / Compatible with SNDVK insert. / Kompatible für SNDVK WP

## T26 90° APKT 1704

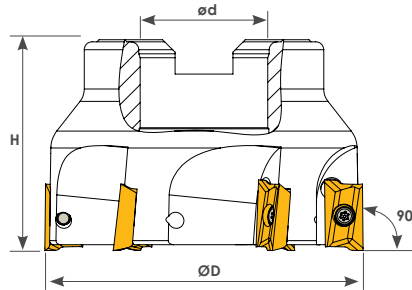

Ölçüler (mm) Dimensions(mm) Abmessungen (mm)		APKT 1704	
L	S		
17	4,76		



Sipariş Kodu Order Code Best.-Nr.	Stok/Stock/Lager	Ürün Kodu Product Code Produkt-Code	Ölçüler (mm) Dimensions(mm) Abmessungen (mm)				Kullanılan Uç Insert WSP	Sıkma Civatası Clamp Screw Torx-Schraube	Anahtar Torx Key Torx-Schlüssel
			ØD	ød	Z	H			
T402	●	D040 d16 Z04 AP--17	40	16	4	45	APKT 1704 R390 SNDVK	TC067 M3,5x8,5	T15
T404	●	D050 d22 Z05 AP--17	50	22	5	45			
T408	●	D063 d22 Z06 AP--17	63	22	6	45			
T411	●	D080 d27 Z07 AP--17	80	27	7	52			
T412	●	D100 d32 Z08 AP--17	100	32	8	52			
T414	●	D125 d40 Z09 AP--17	125	40	9	62			
T416	●	D160 d40 Z10 AP--17	160	40	10	62			

● Stokta / In Stock / Lager ○ Sınırlı Stok / Limited Stock / Begrenzte Lagerhaltung  
SNDVK ucuna uygundur. / Compatible with SNDVK insert. / Kompatible für SNDVK WP



**T28**  
**90° APKT 1705**

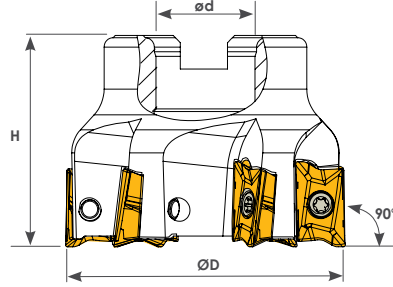

Ölçüler (mm) Dimensions(mm) Abmessungen (mm)		AP-- 1705	
L	S	L 11° S	
17	5,56		

Sipariş Kodu Order Code Best.-Nr.	Stok/Stock/Lager	Ürün Kodu Product Code Produkt-Code	Ölçüler (mm) Dimensions(mm) Abmessungen (mm)				Kullanılan Uç Insert WSP	Sıkma Civatası Clamp Screw Torx-Schraube	Anahtar Torx Key Torx-Schlüssel
			ØD	ød	Z	H			
T550	●	D040 d16 Z04 AP--17	40	16	4	45	AP-- 1705 TGTC	TC074 M4x10	T15
T552	●	D050 d22 Z05 AP--17	50	22	5	45			
T554	●	D063 d22 Z06 AP--17	63	22	6	45			
T556	●	D080 d27 Z07 AP--17	80	27	7	50			
T558	●	D100 d32 Z08 AP--17	100	32	8	52			

TGTCucuna uygundur. / Compatible with TGTCinsert. / Kompatible für TGTCWP

**T30**  
**90° ADKT 1505**

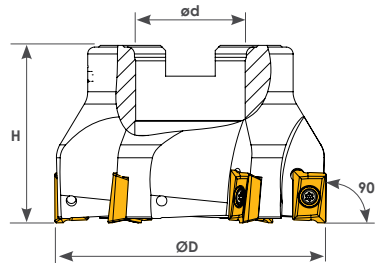

Ölçüler (mm) Dimensions(mm) Abmessungen (mm)		ADKT 1505	
L	S	L 15° S	
15,7	5,63		

Sipariş Kodu Order Code Best.-Nr.	Stok/Stock/Lager	Ürün Kodu Product Code Produkt-Code	Ölçüler (mm) Dimensions(mm) Abmessungen (mm)				Kullanılan Uç Insert WSP	Sıkma Civatası Clamp Screw Torx-Schraube	Anahtar Torx Key Torx-Schlüssel
			ØD	ød	Z	H			
T200	●	D040 d16 Z04 AD--15	40	16	4	45	ADKT 1505 ISCR	TC079 M4x11	T15
T202	●	D050 d22 Z05 AD--15	50	22	5	45			
T204	●	D063 d22 Z06 AD--15	63	22	6	45			
T206	●	D080 d27 Z07 AD--15	80	27	7	52			
T207	●	D100 d32 Z08 AD--15	100	32	8	52			
T208	●	D125 d40 Z09 AD--15	125	40	9	62			

● Stokta/ In Stock / Lager ○ Sınırlı Stok / Limited Stock / Begrenzte Lagerhaltung  
ISCR ucuna uygundur. / Compatible with ISCR insert. / Kompatible für ISCR WP

**T32**  
**90° APKT 1604**

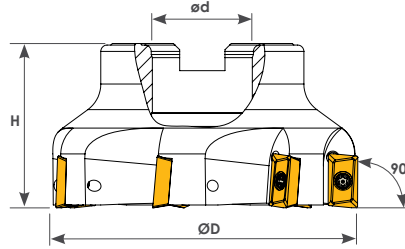

Ölçüler (mm)  
Dimensions (mm)  
Abmessungen (mm)

L	S
16,40	4,76

APKT 1604

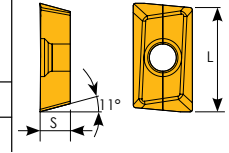

Sipariş Kodu Order Code Best.-Nr.	Stok/Stok/Lager	Ürün Kodu Product Code Produkt-Code	Ölçüler (mm) Dimensions (mm) Abmessungen (mm)				Kullanılan Uç Insert WSP	Sıkma Civatası Clamp Screw Torx-Schraube	Anahtar Torx Key Torx-Schlüssel
			ØD	ød	Z	H			
T180	●	D040 d16 Z03 AP--16	40	16	3	45	AP --1604 KRLY	TC074 M4x10	T15
T181	●	D040 d16 Z04 AP--16	40	16	4	45			
T182	●	D050 d22 Z04 AP--16	50	22	4	45			
T183	●	D050 d22 Z05 AP--16	50	22	5	45			
T184	●	D063 d22 Z05 AP--16	63	22	5	45			
T185	●	D063 d22 Z06 AP--16	63	22	6	45			
T186	●	D080 d27 Z06 AP--16	80	27	6	52			
T187	●	D080 d27 Z07 AP--16	80	27	7	52			
T188	●	D100 d32 Z07 AP--16	100	32	7	52			
T189	●	D100 d32 Z08 AP--16	100	32	8	52			
T190	●	D125 d40 Z09 AP--16	125	40	9	62			
T192	●	D160 d40 Z10 AP--16	160	40	10	62			
T193	●	D200 d60 Z12 AP--16	200	60	12	62			
T195	●	D300 d60 Z15 AP--16	300	60	15	62			

KRLY ucuna uygundur. / Compatible with KRLY insert. / Kompatible für KRLY WP

**T34**  
**90° APKT 1003**

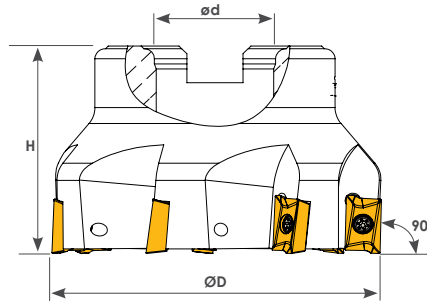

Ölçüler (mm)  
Dimensions (mm)  
Abmessungen (mm)

L	S
10,5	3,52

APKT 1003

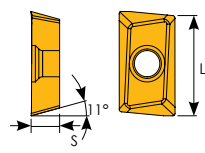

Sipariş Kodu Order Code Best.-Nr.	Stok/Stok/Lager	Ürün Kodu Product Code Produkt-Code	Ölçüler (mm) Dimensions (mm) Abmessungen (mm)				Kullanılan Uç Insert WSP	Sıkma Civatası Clamp Screw Torx-Schraube	Anahtar Torx Key Torx-Schlüssel
			ØD	ød	Z	H			
T176	●	D040 d16 Z05 AP--10	40	16	5	40	AP --1003 KRLY	TC060 M2,5x5,5	T8
T177	●	D050 d22 Z06 AP--10	50	22	6	40			
T178	●	D063 d22 Z07 AP--10	63	22	7	40			
T179	●	D080 d27 Z08 AP--10	80	27	8	50			

● Stokta / In Stock / Lager ○ Sınırlı Stok / Limited Stock / Begrenzte Lagerhaltung  
KRLY ucuna uygundur. / Compatible with KRLY insert. / Kompatible für KRLY WP

**T38**  
**90° ADMT 1204**

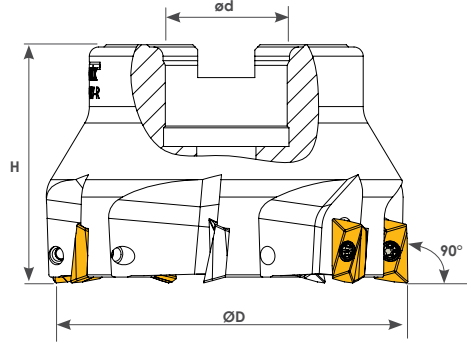

Ölçüler (mm) Dimensions (mm) Abmessungen (mm)		ADMT 1204	
L	S		
13,6	4,76		

Sipariş Kodu Order Code Best.-Nr.	Stok/Stock/Lager	Ürün Kodu Product Code Produkt-Code	Ölçüler (mm) Dimensions (mm) Abmessungen (mm)				Kullanılan Uç Insert WSP	Sıkma Cıvatası Clamp Screw Torx-Schraube	Anahtar Torx Key Torx-Schlüssel
			ØD	ød	Z	H			
T214	●	D040 d16 Z04 AD--12	40	16	4	45	 ADMT 1204 WLTR	 TC065 M3x7	 T8
T215	●	D050 d22 Z05 AD--12	50	22	5	45			
T217	●	D063 d22 Z06 AD--12	63	22	6	45			
T219	●	D080 d27 Z07 AD--12	80	27	7	52			
T220	●	D100 d32 Z08 AD--12	100	32	8	52			

WLTR ucuna uygundur. / Compatible with WLTR insert. / Kompatible für WLTR WP

**T39**  
**90° ADMT 1606**

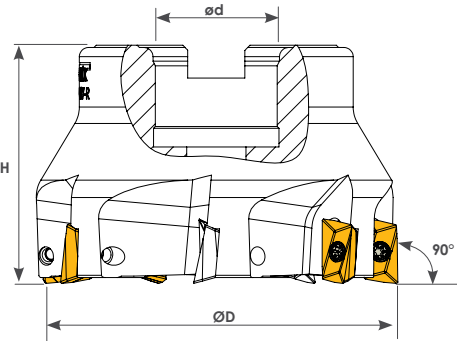

Ölçüler (mm) Dimensions (mm) Abmessungen (mm)		ADMT 1606	
L	S		
17,5	6,15		



Sipariş Kodu Order Code Best.-Nr.	Stok/Stock/Lager	Ürün Kodu Product Code Produkt-Code	Ölçüler (mm) Dimensions (mm) Abmessungen (mm)				Kullanılan Uç Insert WSP	Sıkma Cıvatası Clamp Screw Torx-Schraube	Anahtar Torx Key Torx-Schlüssel
			ØD	ød	Z	H			
T351	●	D040 d16 Z04 AD--16	40	16	4	45	 ADMT 1606 WLTR	 TC079 M4x11	 T15
T352	●	D050 d22 Z05 AD--16	50	22	5	45			
T354	●	D063 d22 Z06 AD--16	63	22	6	45			
T356	●	D080 d27 Z07 AD--16	80	27	7	52			

● Stokta / In Stock / Lager ○ Sınırlı Stok / Limited Stock / Begrenzte Lagerhaltung  
WLTR ucuna uygundur. / Compatible with WLTR insert. / Kompatible für WLTR WP

## 45° SDHT 1204

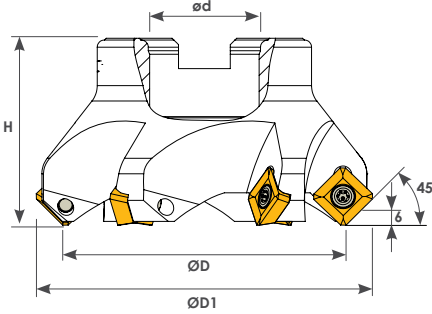

Ölçüler (mm) Dimensions (mm) Abmessungen (mm)		SDHT 1204	
L	S		
12,7	4,76		

Sipariş Kodu Order Code Best.-Nr.	Stok/Stock/Lager	Ürün Kodu Product Code Produkt-Code	Ölçüler (mm) Dimensions (mm) Abmessungen (mm)					Kullanılan Uç Insert WSP	Sıkma Cıvatası Clamp Screw Torx-Schraube	Anahtar Torx Key Torx-Schlüssel
			ØD	ØD1	ød	Z	H			
T300	●	D063 d22 Z05 SD--12	63	76	22	5	45	SDHT 1204 ISO	TC080 M4,5x11	T15
T302	●	D080 d27 Z06 SD--12	80	93	27	6	52			
T304	●	D100 d32 Z07 SD--12	100	113	32	7	62			
T305	●	D125 d40 Z08 SD--12	125	138	40	8	62			

45° SDHT 1204 ISO'dur. / 45° SDHT 1204 is ISO. / Kompatible für ISO WP

## T36 90° BOMT 1304

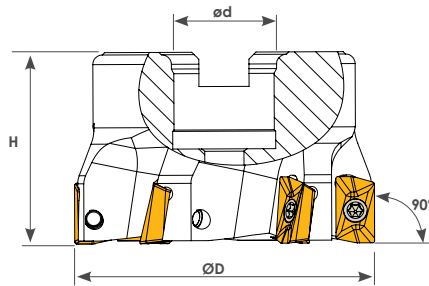

Ölçüler (mm) Dimensions (mm) Abmessungen (mm)			BOMT 1304	
L	S	A		
13	4,5	8		

Sipariş Kodu Order Code Best.-Nr.	Stok/Stock/Lager	Ürün Kodu Product Code Produkt-Code	Ölçüler (mm) Dimensions (mm) Abmessungen (mm)				Kullanılan Uç Insert WSP	Sıkma Cıvatası Clamp Screw Torx-Schraube	Anahtar Torx Key Torx-Schlüssel
			ØD	ød	Z	H			
T965	●	D040 d16 Z04 BO--13	40	16	4	40	BOMT 1304 INGRSLL	TC069 M3,5x8,5	T10
T966	●	D050 d22 Z05 BO--13	50	22	5	40			
T967	●	D063 d22 Z06 BO--13	63	22	6	40			

INGRSLL ucuna uygundur. / Compatible with INGRSLL insert. / Kompatible für INGRSLL WP

● Stokta/ In Stock / Lager ○ Sınırlı Stok / Limited Stock / Begrenzte Lagerhaltung

**T40**  
**45° SEET 12T3-A**

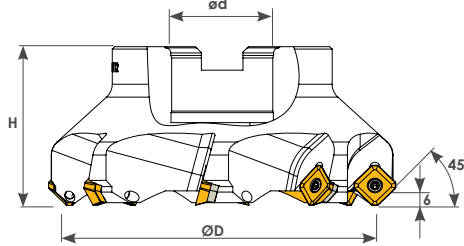

Ölçüler (mm) Dimensions(mm) Abmessungen (mm)		SEET 12T3	
L	S		
13,4	3,97		

Sipariş Kodu Order Code Best.-Nr.	Stok/Stock/Lager	Ürün Kodu Product Code Produkt-Code	Ölçüler (mm) Dimensions(mm) Abmessungen (mm)				Kullanılan Uç Insert WSP	Sıkma Cıvatası Clamp Screw Torx-Schraube	Altlık Shim U-Platte	Altlık Cıvatası Shim Trox Inbuss-Schraube	Anahtar Torx Key Torx-Schlüssel
			ØD	ød	Z	H					
T560	●	D050 d22 Z04 SE--12	50	22	4	40	SEET 12T3 ZCC	TC068 M3,5x11	TA052	TC049 M5x7	T15
T562	●	D063 d22 Z05 SE--12	63	22	5	40					
T564	●	D080 d27 Z06 SE--12	80	27	6	50					
T566	●	D100 d32 Z07 SE--12	100	32	7	50					
T568	●	D125 d40 Z08 SE--12	125	40	8	63					
T570	●	D160 d40 Z10 SE--12	160	40	10	63					

ZCC ucuna uygundur. / Compatible with ZCC insert. / Kompatible für ZCC WP

**T40**  
**45° SEET 12T3**

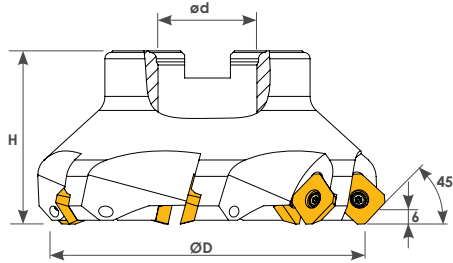

Ölçüler (mm) Dimensions(mm) Abmessungen (mm)		SEET 12T3	
L	S		
13,4	3,97		

Sipariş Kodu Order Code Best.-Nr.	Stok/Stock/Lager	Ürün Kodu Product Code Produkt-Code	Ölçüler (mm) Dimensions(mm) Abmessungen (mm)				Kullanılan Uç Insert WSP	Sıkma Cıvatası Clamp Screw Torx-Schraube	Anahtar Torx Key Torx-Schlüssel
			ØD	ød	Z	H			
T435	●	D063 d22 Z05 SE--12	63	22	5	50	SEET 12T3 ZCC	TC067 M3,5x9	T15
T436	●	D080 d27 Z06 SE--12	80	27	6	55			
T437	●	D100 d32 Z07 SE--12	100	32	7	55			
T438	●	D125 d40 Z08 SE--12	125	40	8	62			

● Stokta/ In Stock / Lager ○ Sınırlı Stok / Limited Stock / Begrenzte Lagerhaltung  
ZCC ucuna uygundur. / Compatible with ZCC insert. / Kompatible für ZCC WP

## T42 RHKW 0802

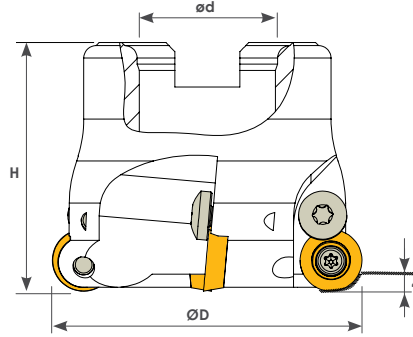

Ölçüler (mm) Dimensions (mm) Abmessungen (mm)		RHKW 0802	
d	S		
8	2,60		

Sipariş Kodu Order Code Best.-Nr.	Stok/Stock/Lager	Ürün Kodu Product Code Produkt-Code	Ölçüler (mm) Dimensions (mm) Abmessungen (mm)				Kullanılan Uç Insert WSP	Baskı Cıvatası Locking Scre Verriegelungs Schraube	Sıkma Cıvatası Clamp Screw Torx-Schraube	Anahtar Torx Key Torx-Schlüssel
			ØD	ød	Z	H				
T599	●	D040 d16 Z04 RH--08	40	16	4	40				
T600	●	D050 d22 Z05 RH--08	50	22	5	40	RHKW 0802 INGRSLL	TC040 M3,5	TC065 M3x7	T8 T15
T601	●	D063 d22 Z06 RH--08	63	22	6	40				

INGRSLL ucuna uygundur. / Compatible with INGRSLL insert. / Kompatible für INGRSLL WP

## T44 RHKW 1003

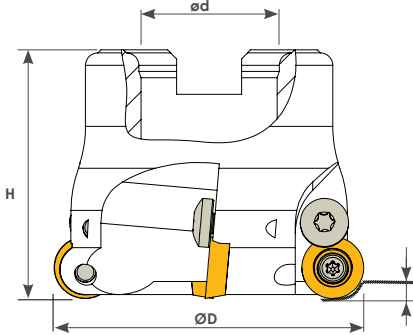

Ölçüler (mm) Dimensions (mm) Abmessungen (mm)		RHKW 1003	
d	S		
10	3,8		

Sipariş Kodu Order Code Best.-Nr.	Stok/Stock/Lager	Ürün Kodu Product Code Produkt-Code	Ölçüler (mm) Dimensions (mm) Abmessungen (mm)				Kullanılan Uç Insert WSP	Baskı Cıvatası Locking Scre Verriegelungs Schraube	Sıkma Cıvatası Clamp Screw Torx-Schraube	Anahtar Torx Key Torx-Schlüssel
			ØD	ød	Z	H				
T602	●	D040 d16 Z04 RH--10	40	16	4	40				
T604	●	D050 d22 Z05 RH--10	50	22	5	40	RHKW 1003 INGRSLL	TC040 M3,5	TC074 M4x10	T15
T606	●	D063 d22 Z06 RH--10	63	22	6	40				
T608	●	D080 d27 Z07 RH--10	80	27	7	50				

● Stokta/ In Stock / Lager ○ Sınırlı Stok / Limited Stock / Begrenzte Lagerhaltung  
INGRSLL ucuna uygundur. / Compatible with INGRSLL insert. / Kompatible für INGRSLL WP

## T46 RHKW 1204

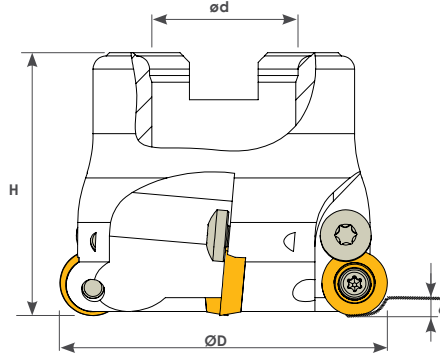

Ölçüler (mm) Dimensions (mm) Abmessungen (mm)		RHKW 1204	
d	S		
12	4,76		

Sipariş Kodu Order Code Best.-Nr.	Stok/Stock/Lager	Ürün Kodu Product Code Produkt-Code	Ölçüler (mm) Dimensions (mm) Abmessungen (mm)				Kullanılan Uç Insert WSP	Baskı Cıvatası Locking Scre Verriegelungs Schraube	Sıkma Cıvatası Clamp Screw Torx-Schraube	Anahtar Torx Key Torx-Schlüssel
			ØD	ød	Z	H				
T612	●	D040 d16 Z04 RH--12	40	16	4	40	RHKW 1204 INGRSLL	TC040 M3,5	TC074 M4x10	T15
T613	●	D050 d22 Z05 RH--12	50	22	5	40				
T614	●	D063 d22 Z06 RH--12	63	22	6	40				
T615	●	D080 d27 Z07 RH--12	80	27	7	50				

INGRSLL ucuna uygundur. / Compatible with INGRSLL insert. / Kompatible für INGRSLL WP

## T47 RPMT 10T3-1204

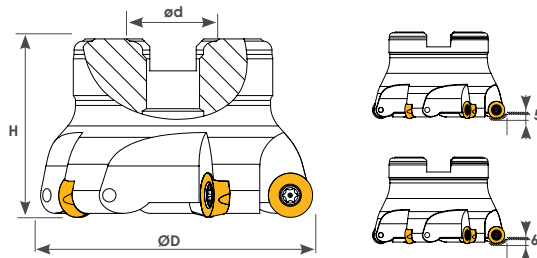

Ölçüler (mm) Dimensions (mm) Abmessungen (mm)		RPMT 1204	
d	S		
12	4,76		
10	3,97		

Sipariş Kodu Order Code Best.-Nr.	Stok/Stock/Lager	Ürün Kodu Product Code Produkt-Code	Ölçüler (mm) Dimensions (mm) Abmessungen (mm)				Kullanılan Uç Insert WSP	Sıkma Cıvatası Clamp Screw Torx-Schraube	Anahtar Torx Key Torx-Schlüssel
			ØD	ød	Z	H			
T391	●	D050 d22 Z05 RP--10	50	22	5	45	RPMT 10T3 MTSBSH	TC067 M3,5x9	T15
T392	●	D063 d22 Z06 RP--10	63	22	6	45			
T395	●	D050 d22 Z05 RP--12	50	22	5	45	RPMT 1204 MTSBSH	TC067 M3,5x9	T15
T396	●	D063 d22 Z06 RP--12	63	22	6	45			

● Stokta/ In Stock / Lager ○ Sınırlı Stok / Limited Stock / Begrenzte Lagerhaltung  
MTSBSH ucuna uygundur. / Compatible with MTSBSH insert. / Kompatible für MTSBSH WP

## RDMT 1003

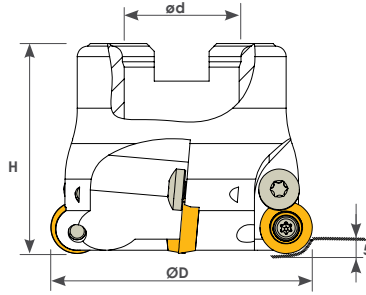

Ölçüler (mm) Dimensions (mm) Abmessungen (mm)		RDMT 1003	
d	S		
10	3,18		

Sipariş Kodu Order Code Best.-Nr.	Stok/Stock/Lager	Ürün Kodu Product Code Produkt-Code	Ölçüler (mm) Dimensions (mm) Abmessungen (mm)				Kullanılan Uç Insert WSP	Baskı Cıvatası Locking Scre Verriegelungs Schraube	Sıkma Cıvatası Clamp Screw Torx-Schraube	Anahtar Torx Key Torx-Schlüssel
			ØD	ød	Z	H				
T288	●	D040 d16 Z03 RD--10	40	16	3	40	RD--1003 ISO	TC040 M3,5	TC067 M3,5x9	T15
T289	●	D040 d16 Z04 RD--10	40	16	4	40				
T290	●	D050 d22 Z04 RD--10	50	22	4	40				
T291	●	D050 d22 Z05 RD--10	50	22	5	40				
T292	●	D063 d22 Z05 RD--10	63	22	5	40				
T293	●	D063 d22 Z06 RD--10	63	22	6	40				
T294	●	D080 d27 Z06 RD--10	80	27	6	50				
T294-1	●	D080 d27 Z07 RD--10	80	27	7	50				
T295	●	D100 d32 Z07 RD--10	100	32	7	50				
T295-1	●	D100 d32 Z08 RD--10	100	32	8	50				

1003 ISO'dur. / RDMT 1003 is ISO. / Kompatible für ISO WP



## RDMT 12T3

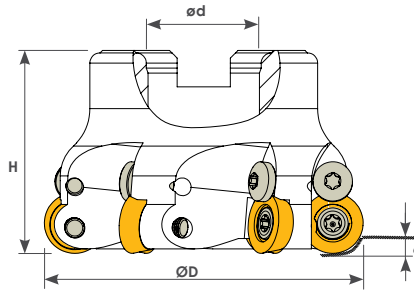

Ölçüler (mm) Dimensions (mm) Abmessungen (mm)		RDMT 12T3	
d	S		
12	3,97		

Sipariş Kodu Order Code Best.-Nr.	Stok/Stock/Lager	Ürün Kodu Product Code Produkt-Code	Ölçüler (mm) Dimensions (mm) Abmessungen (mm)				Kullanılan Uç Insert WSP	Baskı Cıvatası Locking Scre Verriegelungs Schraube	Sıkma Cıvatası Clamp Screw Torx-Schraube	Anahtar Torx Key Torx-Schlüssel
			ØD	ød	Z	H				
T280	●	D040 d16 Z03 RD--12	40	16	3	40	RD--12T3 ISO	TC040 M3,5	TC067 M3,5x9	T15
T281	●	D040 d16 Z04 RD--12	40	16	4	40				
T282	●	D050 d22 Z04 RD--12	50	22	4	40				
T283	●	D050 d22 Z05 RD--12	50	22	5	40				
T284	●	D063 d22 Z05 RD--12	63	22	5	40				
T285	●	D063 d22 Z06 RD--12	63	22	6	40				
T286	●	D080 d27 Z06 RD--12	80	27	6	50				
T286-1	●	D080 d27 Z07 RD--12	80	27	7	50				
T287	●	D100 d32 Z07 RD--12	100	32	7	50				
T287-1	●	D100 d32 Z08 RD--12	100	32	8	50				

● Stokta/ In Stock / Lager ○ Sınırlı Stok / Limited Stock / Begrenzte Lagerhaltung  
RDMT 12T3 ISO'dur. / RDMT 12T3 is ISO. / Kompatible für ISO WP



## T48 RCKT 1204

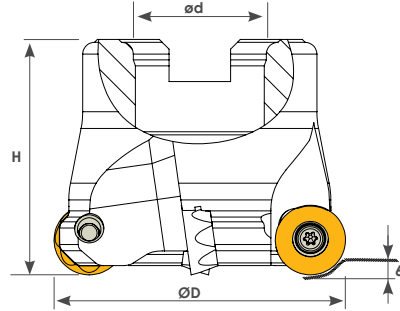

RCKT 1204	
Ölçüler (mm) Dimensions (mm) Abmessungen (mm)	
D	S
12	4,76

Sipariş Kodu Order Code Best.-Nr.	Stok/Stock/Lager	Ürün Kodu Product Code Produkt-Code	Ölçüler (mm) Dimensions (mm) Abmessungen (mm)				Kullanılan Uç Insert WSP	Sıkma Cıvatası Clamp Screw Torx-Schraube	Anahtar Torx Key Torx-Schlüssel
			ØD	ød	Z	H			
T460	●	D050 d22 Z04 RC--12	50	22	4	40	RCKT 1204 SNDVK	TC068 M3,5x11	T15
T462	●	D063 d22 Z05 RC--12	63	22	5	40			
T464	●	D080 d27 Z06 RC--12	80	27	6	50			
T466	●	D100 d32 Z07 RC--12	100	32	7	50			

SNDVK ucuna uygundur. / Compatible with SNDVK insert. / Kompatible für SNDVK WP

## T50 RDMT 1604

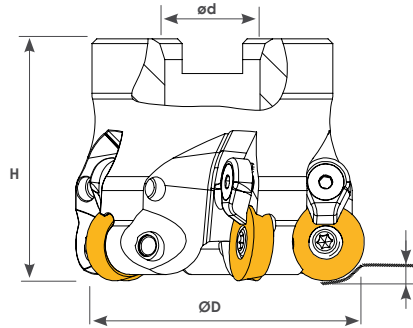

RD-- 1604	
Ölçüler (mm) Dimensions (mm) Abmessungen (mm)	
d	S
16	4,76

Sipariş Kodu Order Code Best.-Nr.	Stok/Stock/Lager	Ürün Kodu Product Code Produkt-Code	Ölçüler (mm) Dimensions (mm) Abmessungen (mm)				Kullanılan Uç Insert WSP	Baskı Kepi Clamp Spann pratze	Baskı Cıvatası Locking Screw Verriegelungs Schraube	Sıkma Cıvatası Clamp Screw Torx-Schraube	Anahtar Torx Key Torx-Schlüssel
			ØD	ød	Z	H					
T270	●	D050 d22 Z04 RD--16	50	22	4	40	RD-- 1604 ISO	BK035	TC038 M4	TC083 M5x12	T20
T271	●	D052 d22 Z04 RD--16	52	22	4	40					
T273	●	D063 d22 Z05 RD--16	63	22	5	45					
T274	●	D080 d27 Z06 RD--16	80	27	6	50					
T275	●	D100 d32 Z07 RD--16	100	32	7	50					

● Stokta / In Stock / Lager ○ Sınırlı Stok / Limited Stock / Begrenzte Lagerhaltung  
RDMT 1604 ISO'dur. / RDMT 1604 is ISO. / Kompatible für ISO WP

## 90° VCGT 16- DCMT 11T3

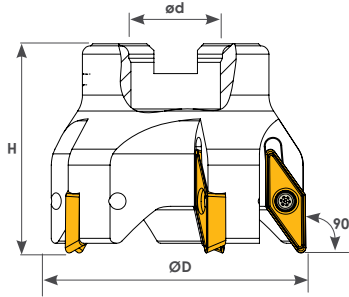

Ölçüler (mm) Dimensions(mm) Abmessungen (mm)		VCGT 16 -DCMT 11	
L	S		
16,6	4,76		
11	3,97		

Sipariş Kodu Order Code Best.-Nr.	Stok/Stock/Lager	Ürün Kodu Product Code Produkt-Code	Ölçüler (mm) Dimensions(mm) Abmessungen (mm)				Kullanılan Uç Insert WSP	Sıkma Cıvatası Clamp Screw Torx-Schraube	Anahtar Torx Key Torx-Schlüssel
			ØD	ød	Z	H			
T498	●	D040 d16 Z03 VC--16	40	16	3	52	VCGT 16 ISO	TC074 M4x10	T15
T500	●	D050 d22 Z04 VC--16	50	22	4	52			
T502	●	D063 d22 Z05 VC--16	63	22	5	52			
T504	●	D080 d27 Z06 VC--16	80	27	6	52			
T506	●	D063 d22 Z05 DC--11	63	22	5	52			

VCGT 16 ISO'dur. / VCGT 16 is ISO. / Kompatible für ISO WP

## T52 90° SPMG 0904

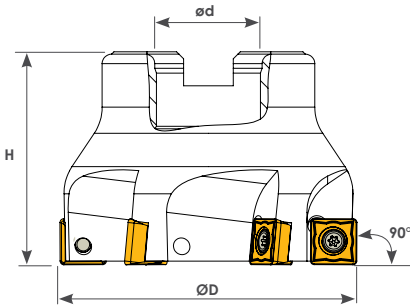

Ölçüler (mm) Dimensions(mm) Abmessungen (mm)		SPMG 0904	
L	S		
9,8	4,30		



Sipariş Kodu Order Code Best.-Nr.	Stok/Stock/Lager	Ürün Kodu Product Code Produkt-Code	Ölçüler (mm) Dimensions(mm) Abmessungen (mm)				Kullanılan Uç Insert WSP	Sıkma Cıvatası Clamp Screw Torx-Schraube	Anahtar Torx Key Torx-Schlüssel
			ØD	ød	Z	H			
T338	●	D050 d22 Z05 SP--09	50	22	5	45	SPMG 0904 TGTC	TC067 M3,5x9	T15
T340	●	D063 d22 Z06 SP--09	63	22	6	45			
T342	●	D080 d27 Z07 SP--09	80	27	7	52			

● Stokta/ In Stock / Lager ○ Sınırlı Stok / Limited Stock / Begrenzte Lagerhaltung  
TGTCucuna uygundur. / Compatible with TGTCinsert. / Kompatible für TGTCWP

## T54 F 75° APKT 1604

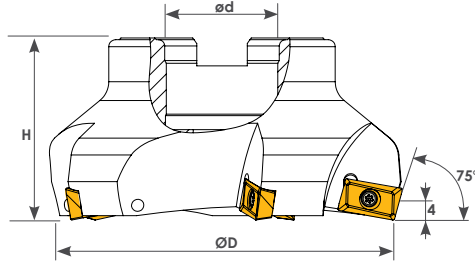

Ölçüler (mm) Dimensions(mm) Abmessungen (mm)		AP-- 1604	AP-- 1003
L	S		
16,40	4,76	11°	L
10	3,52	S	L

Sipariş Kodu Order Code Best.-Nr.	Stok/Stock/Lager	Ürün Kodu Product Code Produkt-Code	Ölçüler (mm) Dimensions(mm) Abmessungen (mm)				Kullanılan Uç Insert WSP	Sıkma Cıvatası Clamp Screw Torx-Schraube	Anahtar Torx Key Torx-Schlüssel
			ØD	ød	Z	H			
T308	●	D063 d22 Z04 AP--16	63	22	4	45	AP-- 1604 KRLY	TC074 M4x10	T15
T310	●	D080 d27 Z05 AP--16	80	27	5	52			
T312	●	D100 d32 Z06 AP--16	100	32	6	52			
T313	●	D125 d40 Z07 AP--16	125	40	7	62			
T452	●	D063 d22 Z06 AP--10	63	22	6	45	AP-- 1003 KRLY	TC63 M2,5x7	T8

KRLY ucuna uygundur. / Compatible with KRLY insert. / Kompatible für KRLY WP

## T56 F 75° ADKT 1505

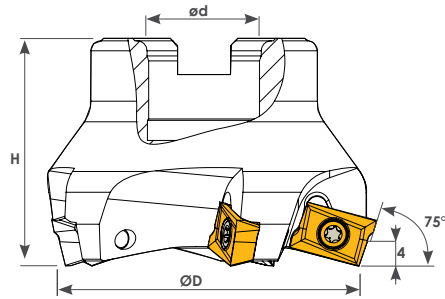

Ölçüler (mm) Dimensions(mm) Abmessungen (mm)		ADKT 1505	
L	S		
15,70	5,63	15°	L

Sipariş Kodu Order Code Best.-Nr.	Stok/Stock/Lager	Ürün Kodu Product Code Produkt-Code	Ölçüler (mm) Dimensions(mm) Abmessungen (mm)				Kullanılan Uç Insert WSP	Sıkma Cıvatası Clamp Screw Torx-Schraube	Anahtar Torx Key Torx-Schlüssel
			ØD	ød	Z	H			
T530	●	D063 d22 Z05 AD--15	63	22	5	45	ADKT 1505 ISCR	TC074 M4x10	T15
T532	●	D080 d27 Z06 AD--15	80	27	6	50			

● Stokta / In Stock / Lager ○ Sınırlı Stok / Limited Stock / Begrenzte Lagerhaltung  
ISCR ucuna uygundur. / Compatible with ISCR insert. / Kompatible für ISCR WP

## 75° SPKN 1203

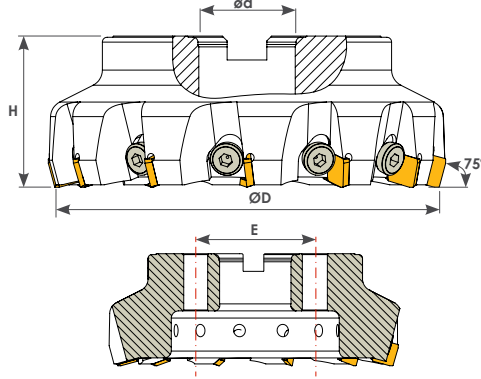

Ölçüler (mm) Dimensions (mm) Abmessungen (mm)		SPKN 1203	
L	S		
12,7	3,18		

Sipariş Kodu Order Code Best.-Nr.	Stok/Stock/Lager	Ürün Kodu Product Code Produkt-Code	Ölçüler (mm) Dimensions (mm) Abmessungen (mm)					Kullanılan Uç Insert WSP	Sıkma Civatası Clamp Screw Inbuss-Schraube	Anahtar Allen Key Inbuss-Schlüssel
			ØD	ød	Z	H	E			
T152	●	D080 d27 Z06 SP--12	80	27	6	55	---	SPKN 1203 ISO	TC056 SOL M8x24	5 Allen
T154	●	D100 d32 Z08 SP--12	100	32	8	55	---			
T156	●	D125 d40 Z10 SP--12	125	40	10	62	---			
T158	●	D160 d40 Z12 SP--12	160	40	12	62	66,7			
T160	●	D200 d60 Z12 SP--12	200	60	12	62	101,6			
T162	●	D300 d60 Z20 SP--12	300	60	20	65	101,6			

SPKN 1203 ISO'dur. / SPKN 1203 is ISO. / Kompatible für ISO WP

## 75° SPKN 1203

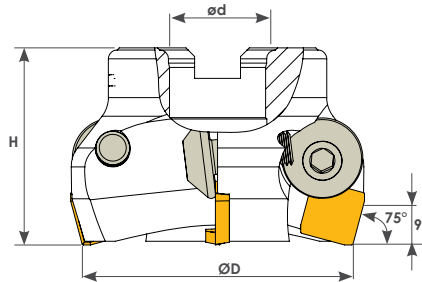

Ölçüler (mm) Dimensions (mm) Abmessungen (mm)		SPKN 1203	
L	S		
12,7	3,18		

Sipariş Kodu Order Code Best.-Nr.	Stok/Stock/Lager	Ürün Kodu Product Code Produkt-Code	Ölçüler (mm) Dimensions (mm) Abmessungen (mm)				Kullanılan Uç Insert WSP	Sıkma Civatası Clamp Screw Inbuss-Schraube	Anahtar Allen Key Inbuss-Schlüssel
			ØD	ød	Z	H			
T148	●	D050 d22 Z03 SP--12	50	22	3	45	SPKN 1203 ISO	TC054 M8x24	5 Allen
T150	●	D063 d22 Z04 SP--12	63	22	4	45			

● Stokta / In Stock / Lager ○ Sınırlı Stok / Limited Stock / Begrenzte Lagerhaltung  
SPKN 1203 ISO'dur. / SPKN 1203 is ISO. / Kompatible für ISO WP

## 90° TPKN 1603-2204

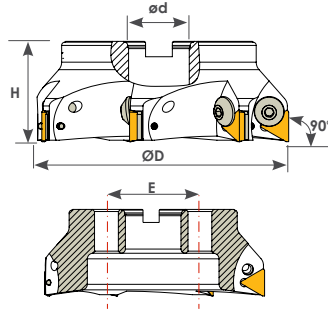

Ölçüler (mm) Dimensions (mm) Abmessungen (mm)		TPKN 1603
L	S	
16,5	3,18	
22	4,76	
Ölçüler (mm) Dimensions (mm) Abmessungen (mm)		TPKN 2204
L	S	
16,5	3,18	
22	4,76	

### Altlıklı - With Shim - Mit U-Platte

Sipariş Kodu Order Code Best.-Nr.	Stok/Stock/Lager	Ürün Kodu Product Code Produkt-Code	Ölçüler (mm) Dimensions (mm) Abmessungen (mm)					Kullanılan Uç Insert WSP	Baskı Cıvatası Locking Screw Verriegelungs-Schraube	Altlık Shim U-Platte	Altlık Cıvatası Shim Trox Inbuss-Schraube	Anahtar Allen Key Inbuss-Schlüssel	
			ØD	ød	Z	H	E						
T100	●	D080 d32 Z05 TP--16 A	80	32	5	52	--	TPKN 1603 ISO		TC052 M6x17	TA010	TC045 M3	4 Allen
T102	●	D100 d32 Z06 TP--16 A	100	32	6	52	--						
T104	●	D080 d32 Z04 TP--22 A	80	32	4	52	--						
T106	●	D100 d32 Z05 TP--22 A	100	32	5	52	--						
T108	●	D125 d40 Z06 TP--22 A	125	40	6	62	--	TPKN 2204 ISO		TC054 M8x24	TA012	TC038 M4x10	5 Allen
T110	●	D160 d40 Z07 TP--22 A	160	40	7	62	66,7						
T112	●	D200 d60 Z08 TP--22 A	200	60	8	62	101,6						
T113	●	D250 d60 Z09 TP--22 A	250	60	9	62	101,6						

TPKN 1603-2204 ISO'dur. / TPKN 1603-2204 is ISO. / Kompatible für ISO WP

## 90° TPKN 1603-2204

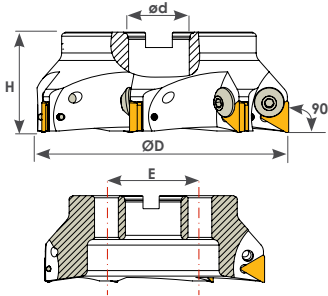

Ölçüler (mm) Dimensions (mm) Abmessungen (mm)		TPKN 1603
L	S	
16,5	3,18	
22	4,76	
Ölçüler (mm) Dimensions (mm) Abmessungen (mm)		TPKN 2204
L	S	
16,5	3,18	
22	4,76	



Sipariş Kodu Order Code Best.-Nr.	Stok/Stock/Lager	Ürün Kodu Product Code Produkt-Code	Ölçüler (mm) Dimensions (mm) Abmessungen (mm)					Kullanılan Uç Insert WSP	Sıkma Cıvatası Clamp screw Inbuss-Schraube	Anahtar Allen Key Inbuss-Schlüssel
			ØD	ød	Z	H	E			
T114	●	D042 d16 Z03 TP--16	42	16	3	44	--	TPKN 1603 ISO	TC052 M6x17	4 Allen
T116	●	D050 d22 Z03 TP--16	50	22	3	44	--			
T118	●	D063 d22 Z03 TP--16	63	22	3	44	--			
T120	●	D063 d22 Z04 TP--16	63	22	4	44	--			
T122	●	D080 d32 Z05 TP--16	80	32	5	52	--			
T124	●	D100 d32 Z06 TP--16	100	32	6	52	--			
T126	●	D063 d22 Z03 TP--22	63	22	3	50	--	TPKN 2204 ISO	TC054 M8x24	5 Allen
T128	●	D080 d32 Z04 TP--22	80	32	4	52	--			
T130	●	D100 d32 Z05 TP--22	100	32	5	52	--			
T132	●	D125 d40 Z06 TP--22	125	40	6	62	--			
T134	●	D160 d40 Z07 TP--22	160	40	7	62	66,7			
T136	●	D200 d60 Z08 TP--22	200	60	8	62	101,6			
T138	●	D250 d60 Z09 TP--22	250	60	9	62	101,6			

● Stokta/ In Stock / Lager ○ Sınırlı Stok / Limited Stock / Begrenzte Lagerhaltung  
TPKN 1603-2204 ISO'dur. / TPKN 1603-2204 is ISO. / Kompatible für ISO WP

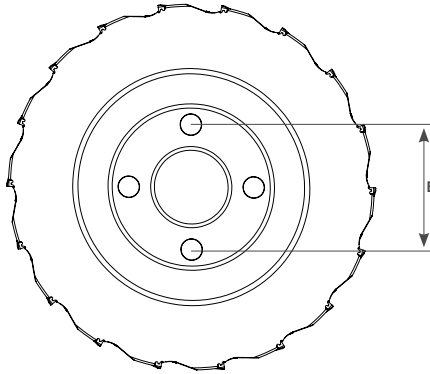
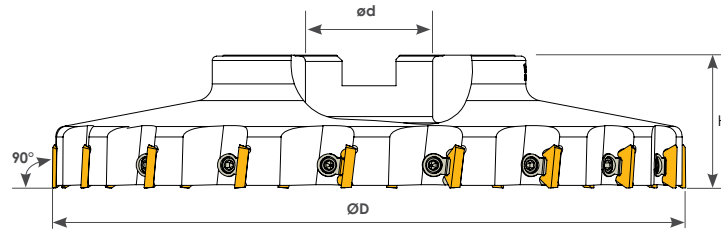
## 90° TPKN 2204

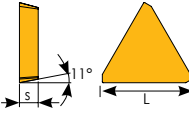
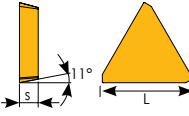

Ölçüler (mm) Dimensions (mm) Abmessungen (mm)		TPKN 2204	
L	S		
22	4,76		

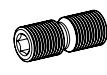
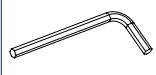
Sipariş Kodu Order Code Best.-Nr.	Stok/Stock/Lager	Ürün Kodu Product Code Produkt-Code	Ölçüler (mm) Dimensions (mm) Abmessungen (mm)					Kullanılan Uç Insert WSP	Baskı Kepi Clamp Spannpratze	Sıkma Cıvatası Clamp Screw Inbuss-Schraube	Anahtar Allen Key Inbusschlüssel
			ØD	ød	Z	H	E				
T071	●	D080 d27 Z06 TP--22	80	27	6	50	---				
T929	●	D300 d60 Z18 TP--22	300	60	18	62	101,6	TPKN 2204 ISO	BK300	TC300 M8x18	4 Allen

● Stokta/ In Stock / Lager ○ Sınırlı Stok / Limited Stock / Begrenzte Lagerhaltung  
TPKN 2204 ISO'dur. /TPKN 2204 is ISO. / Kompatibel für ISO WP



تکنیک تولز

ابزار آلات صنعتی، تراشکاری و ماشینکاری

۶۶۶۷۷۶۶ - ۶۶۶۷۷۶۶

تهران، خ امام خمینی، م حسن آباد، پاساژ هشت گنبد، شماره ۱۵

**Baralar**  
Boring Tools  
Ausbohrwerkzeug



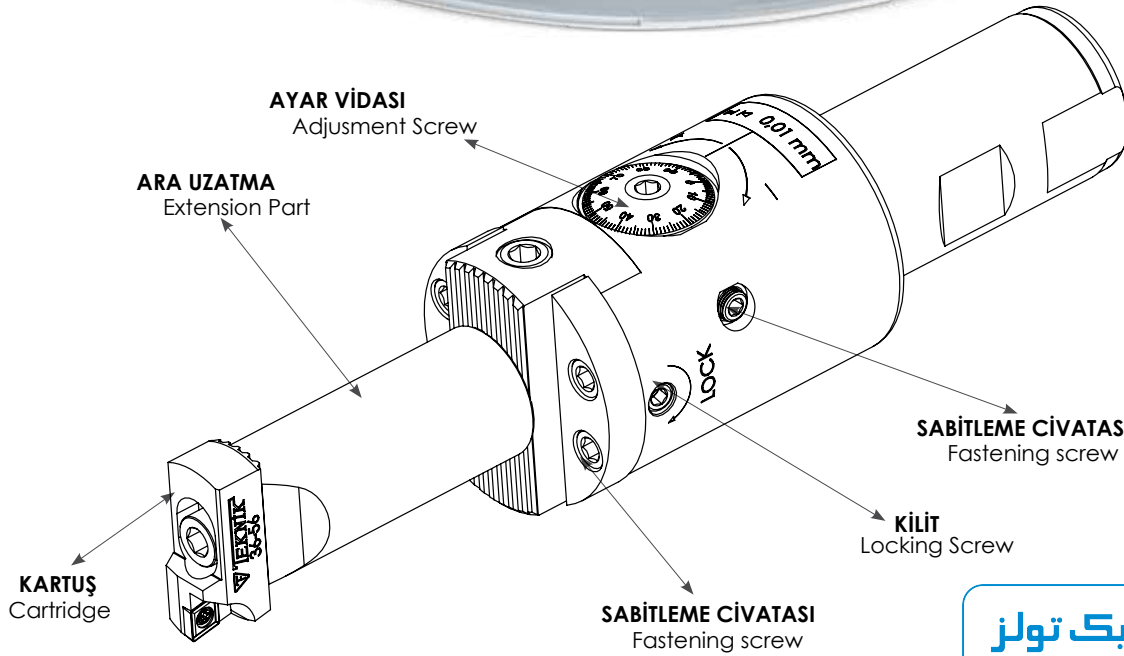



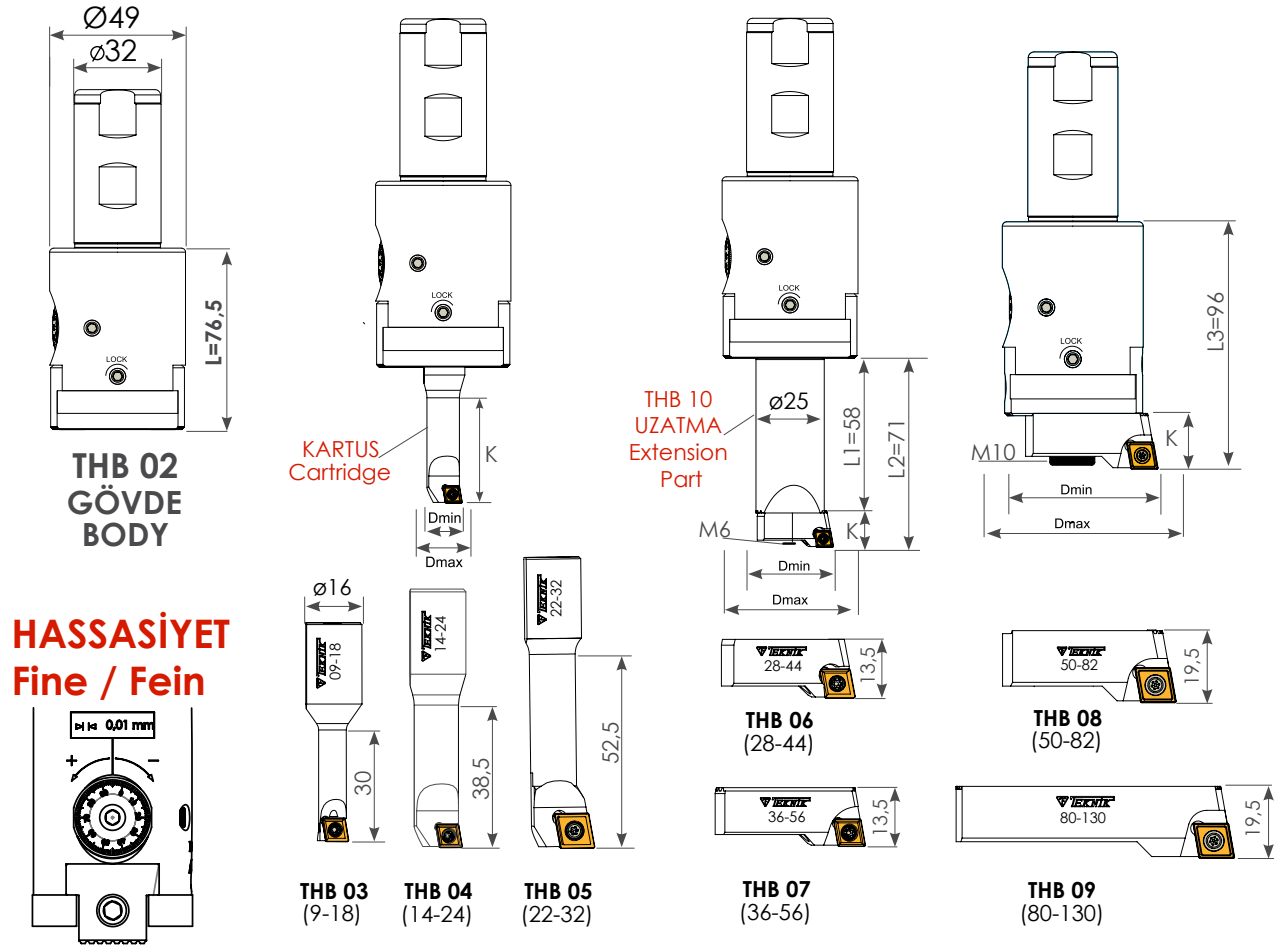

## THB 01 SET (1 Gövde + 7 Kartuş )

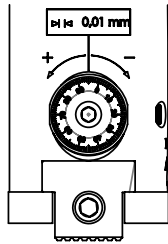

**HASSASİYET**  
Fine / Fein

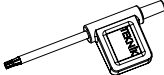

Sipariş Kodu Order Code Best.-Nr.	Stok/Stock/Lager	Ürün Kodu Product Code Produkt-Code	K	L1	L2	L3	Dmin - Dmax	Kullanılan Uç Insert WSP	Sıkma Cıvatası Clamp Screw Torx-Schraube	Anahtar Torx Key Torx-Schlüssel
										
THB 01	●	HASSAS BARA SETİ / SET	...	...	...	...	9-130	...	...	...
THB 02	●	GÖVDE / BODY	...	...	...	...	...	...	...	...
THB 03	●	09-18 Kartuş/Cartridge	30	...	...	...	9-18	...	...	...
THB 04	●	14-24 Kartuş/Cartridge	38,5	...	...	...	14-24	CC -- 0602	TC060 M2,5x5,5	T8
THB 05	●	22-32 Kartuş /Cartridge	52,5	...	...	...	22-32	CC -- 09T3	TC067 M3,5x9	T15
THB 06	●	28-44 Kartuş/Cartridge	13,5	...	71	...	28-44	CC -- 0602	TC060 M2,5x5,5	T8
THB 07	●	36-56 Kartuş /Cartridge	13,5	...	71	...	36-56	CC -- 0602	TC060 M2,5x5,5	T8
THB 08	●	50-82 Kartuş/Cartridge	19,5	...	...	96	50-82	CC -- 09T3	TC067 M3,5x8,5	T15
THB 09	●	80-130 Kartuş/Cartridge	19,5	...	...	96	80-130	CC -- 09T3	TC067 M3,5x8,5	T15
THB 10	●	ARA UZATMA/Extension Part	...	58	...	...	...	...	...	...

● Stokta / In Stock / Lager ○ Sınırlı Stok / Limited Stock / Begrenzte Lagerhaltung

**تکنیک تولز**  
ابزار آلات صنعتی - تراشکاری و قالبسازی  
۶۶۷۱۱۷۲۹ - ۶۶۷۱۱۹۶۷  
تهران، خ امام خمینی، م حسن آباد، پاساژ هشت گنبد، شماره ۱۵



Sipariş Kodu Order Code Best.-Nr.	Stok/Stock/Lager	Ürün Kodu Product Code Produkt-Code	Ölçüler (mm) Dimensions (mm) Abmessungen (mm)							Kullanılan Uç Insert WSP	Hassasiyet Fine Fein
			Dmin	Dmax	K	øD1	L1	øD2	L		
THKB120	●	25-32 K050 CC--06	25	32	50	25	56	23	106	CC -- 0602	0,02
THKB122	●	25-32 K100 CC--06	25	32	100	25	56	23	156		
THKB126	●	32-40 K060 CC--06	32	40	60	25	56	29	116	CC -- 0602	0,01
THKB128	●	32-40 K104 CC--06	32	40	104	25	56	29	160		
THKB132	●	40-50 K069 CC--06	40	50	69	25	56	36	125		
THKB134	●	40-50 K110 CC--06	40	50	110	25	56	36	165		
THKB136	●	40-50 K190 CC--06	40	50	190	25	56	36	245	CC -- 09T3	0,01
THKB138	●	50-65 K065 CC--09	50	65	65	32	60	47	125		
THKB140	●	50-65 K130 CC--09	50	65	130	32	60	47	190		
THKB142	●	50-65 K220 CC--09	50	65	220	32	60	47	280		
THKB144	●	65-80 K085 CC--09	65	80	85	32	60	60	145		
THKB146	●	65-80 K130 CC--09	65	80	130	32	60	60	190		
THKB148	●	65-80 K220 CC--09	65	80	220	32	60	60	280		

● Stokta / In Stock / Lager ○ Sınırlı Stok / Limited Stock / Begrenzte Lagerhaltung

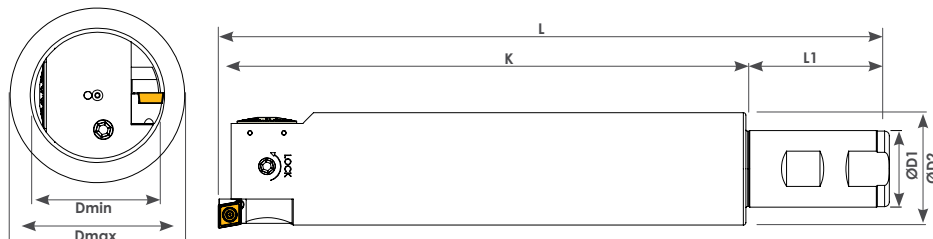

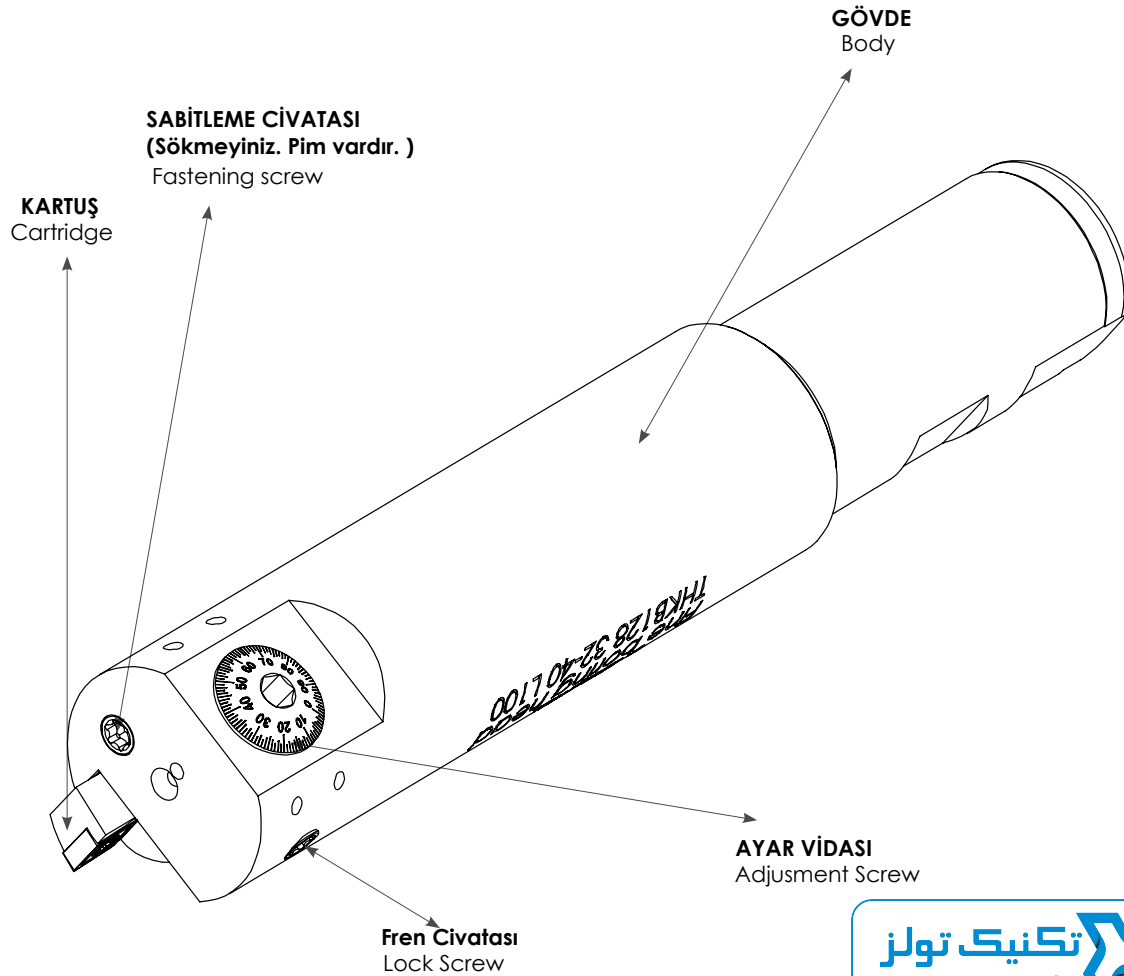

Dmin-Dmax	Kartuşlar Cartridges Kartusche	Kullanılan Uç Insert WSP	Sıkma Cıvatası Clamp Screw Torx-Schraube	Sabitleme Cıvatası Locking Screw Verriegelungs Schraube	Ayar Cıvatası Adjustment Screw Einstells- chraube	Anahtar Torx Key Torx-Schlüssel	
25-32	KR150	CC--0602	TC060 M2,5x5,5	SK47-M6x6	PC14-M5x17	T8	2,5 Allen
32-40	KR151	CC--0602	TC060 M2,5x5,5	SK47-M5x6	PC16-M5x19	T8	2,5 Allen
40-50	KR152	CC--0602	TC060 M2,5x5,5	SK47-M6x6	PC18-M5x23	T8	
50-65	KR153	CC--09T3	TC067 M3,5x9	SK48-M8x8	PC22-M8x37	T15	
65-80	KR154	CC--09T3	TC067 M3,5x9	SK48-M8x8	PC22-M8x37	T15	



تکنیک تولز

ابزار آلات صنعتی، تراشکاری و ماشینکاری  
تهران، خ امام خمینی، م حسن آباد، پاساژ هشت گنبد، شماره ۱۵  
۶۶۷۱۱۳۹ - ۶۶۷۱۱۹۶۷

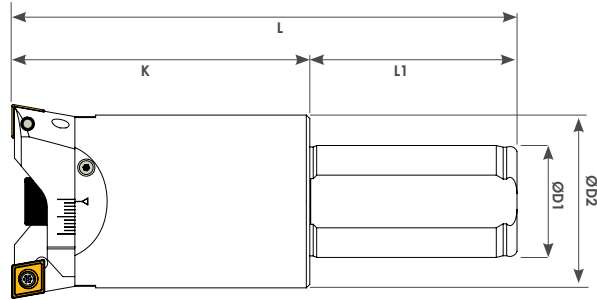
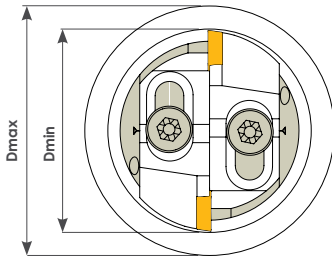

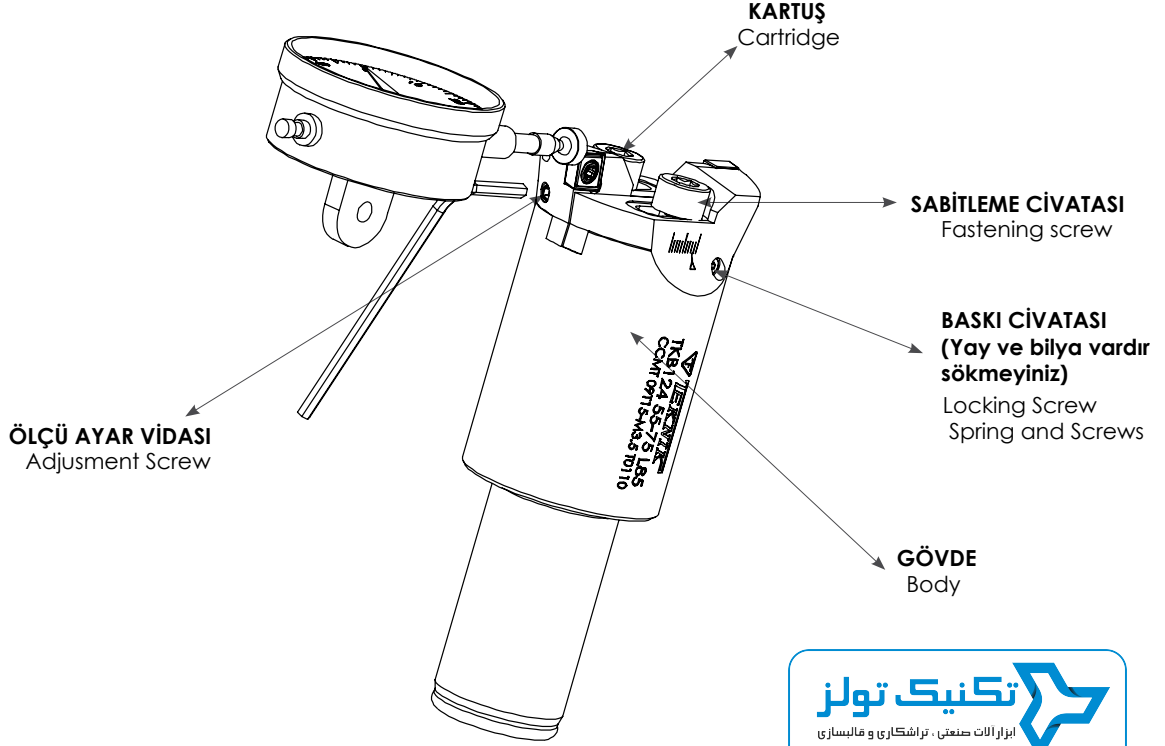

Sipariş Kodu Order Code Best.-Nr.	Stok/Stock/Lager	Ürün Kodu Product Code Produkt-Code	Ölçüler (mm) Dimensions (mm) Abmessungen (mm)							Kullanılan Uç Insert WSP
			Dmin	Dmax	K	ØD1	L1	ØD2	L	
TKB088	●	16-20 K052 WC--03	16	20	52	16	48	16	100	WC-- 0302
TKB090	●	16-20 K102 WC--03	16	20	102	16	48	16	150	
TKB092	●	16-20 K152 WC--03	16	20	152	16	48	16	200	
TKB094	●	19-23 K052 CC--06	19	23	52	16	48	17,5	100	CC -- 0602
TKB096	●	19-23 K102 CC--06	19	23	102	16	48	17,5	150	
TKB098	●	19-23 K152 CC--06	19	23	152	16	48	17,5	200	
TKB100	●	23-28 K050 CC--06	23	28	50	20	50	21	100	
TKB102	●	23-28 K100 CC--06	23	28	100	20	50	21	150	
TKB104	●	23-28 K184 CC--06	23	28	184	20	50	21	234	
TKB106	●	28-38 K055 CC--09	28	38	55	20	50	25	105	CC -- 09T3
TKB108	●	28-38 K105 CC--09	28	38	105	20	50	25	155	
TKB110	●	28-38 K175 CC--09	28	38	175	25	56	25	231	
TKB111	●	28-38 K275 CC--09	28	38	275	25	56	25	331	
TKB112	●	37-48 K066 CC--09	37	48	66	25	56	32	122	
TKB114	●	37-48 K115 CC--09	37	48	115	25	56	33	171	
TKB116	●	37-48 K202 CC--09	37	48	202	25	56	33	258	
TKB118	●	45-56 K067 CC--09	45	56	67	32	60	40	127	
TKB120	●	45-56 K116 CC--09	45	56	116	32	60	40	177	
TKB122	●	45-56 K201 CC--09	45	56	201	32	60	40	261	
TKB124	●	55-75 K085 CC--09	55	75	85	32	60	50	145	
TKB126	●	55-75 K135 CC--09	55	75	135	32	60	50	195	
TKB128	●	55-75 K220 CC--09	55	75	220	32	60	50	280	
TKB130	●	70-90 K085 CC--09	70	90	85	32	60	63	145	
TKB132	●	70-90 K135 CC--09	70	90	135	32	60	63	195	
TKB134	●	70-90 K220 CC--09	70	90	220	40	70	63	290	
TKB136	●	90-130 K115 CC--09	90	130	115	32	60	75	175	
TKB138	●	90-130 K165 CC--09	90	130	165	32	60	75	225	

● Stokta / In Stock / Lager ○ Sınırlı Stok / Limited Stock / Begrenzte Lagerhaltung

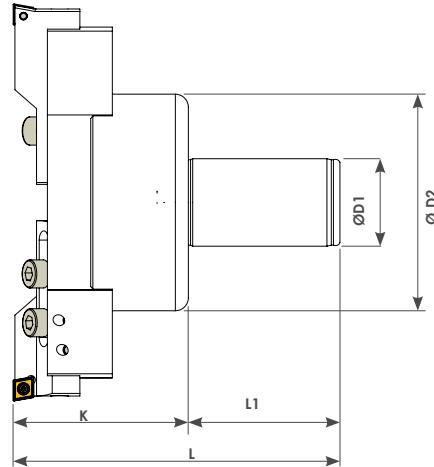
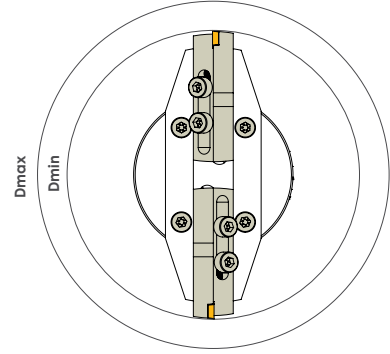

Dmin-Dmax	Kartuşlar Cartridges Kartusche	Kullanılan Uç Insert WSP	Sıkma Cıvatası Clamp Screw Torx-Schraube	Sabitleme Cıvatası Locking Screw Verriegelungs Schraube	Ayar Cıvatası Adjustment Screw Einstellschraube	Anahtar Torx Key Torx-Schlüssel
16-20	KR096	WC-- 0302	TC060 M2,5x5,5	TC102-M4x16	---	T8
19-23	KR098	CC-- 0602	TC060 M2,5x5,5	TC102-M4x16	---	T8
23-28	KR100	CC-- 0602	TC060 M2,5x5,5	TC104-M5x25	SK30-M3x5	T8
28-38	KR102	CC-- 09T3	TC067 M3,5x9	TC104-M5x25	SK32-M4x7	T15
37-48	KR104	CC-- 09T3	TC067 M3,5x9	TC106-M6x30	SK34-M4x10	T15
45-56	KR106	CC-- 09T3	TC067 M3,5x9	TC108-M8x30	SK36-M4x12	T15
55-75	KR108	CC-- 09T3	TC067 M3,5x9	TC108-M8x30	SK38-M4x16	T15
70-90	KR110	CC-- 09T3	TC067 M3,5x9	TC108-M8x30	SK38-M4x16	T15
90-130	KR112	CC-- 09T3	TC067 M3,5x9	TC108-M8x30	SK40-M4x25	T15
55-75	KR115	CC-- 1204	TC083 M5x12	TC108-M8x30	SK42-M8x30	T20
70-90	KR116	CC-- 1204	TC083 M5x12	TC108-M8x30	SK42-M8x30	T20
90-130	KR117	CC-- 1204	TC083 M5x12	TC108-M8x30	SK42-M8x30	T20



Sipariş Kodu Order Code Best.-Nr.	Stok/Stock/Lager	Ürün Kodu Product Code Produkt-Code	Ölçüler (mm) Dimensions (mm) Abmessungen (mm)								Kullanılan Uç Insert WSP
			Dmin	Dmax	K	ØD1	L1	ØD2	L	 CC -- 1204	
TKB148	●	120-170 K065 CC--12	120	170	65	40	70	100	135		
TKB150	●	170-250 K080 CC--12	170	250	80	40	70	100	150		
TKB152	●	240-350 K080 CC--12	240	350	80	40	70	100	150		

● Stokta / In Stock / Lager ○ Sınırlı Stok / Limited Stock / Begrenzte Lagerhaltung

**تکنیک تولز**

ابزار آلات صنعتی، تراشکاری و ماشینکاری

۱۵ شماره ۱۵ - ۱۶۷۱۱۷۲۹ - ۱۶۷۱۱۹۶۷

تهران، خ امام خمینی، م حسن آباد، پاساژ هشت گنبد، شماره ۱۵

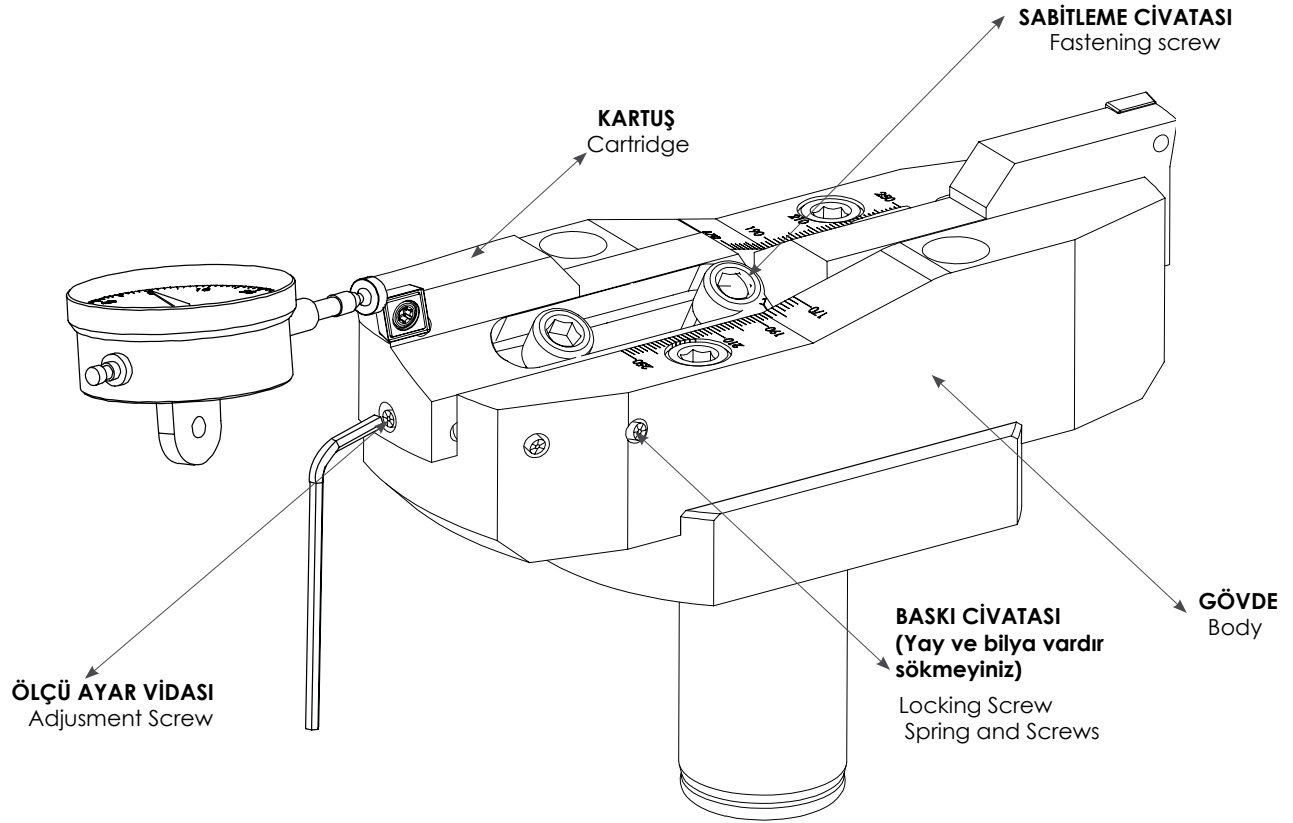

Dmin-Dmax	Kartuşlar Cartridges Kartusche	Kullanılan Uç Insert WSP	Sıkma Cıvatası Clamp Screw Torx-Schraube	Sabitleme Cıvatası Locking Screw Verriegelungs Schraube	Ayar Cıvatası Adjustment Screw Einstellschraube	Anahtar Torx Key Torx-Schlüssel
120-170	KR119	CC-- 1204	TC083 M5x12	TC109-M8x25	SK42-M8x30	T20
170-250	KR120	CC-- 1204	TC083 M5x12	TC109-M8x25	SK42-M8x30	T20
240-350	KR124	CC-- 1204	TC083 M5x12	TC109-M8x25	SK42-M8x30	T20

**تکنیک تولز**

ابزار آلات صنعتی، تراشکاری و ماشینکاری

۶۶۷۱۱۷۳۹ - ۶۶۷۱۱۹۶۷

تهران، خ امام خمینی، م حسن آباد، پاساژ هشت گنبد، شماره ۱۵

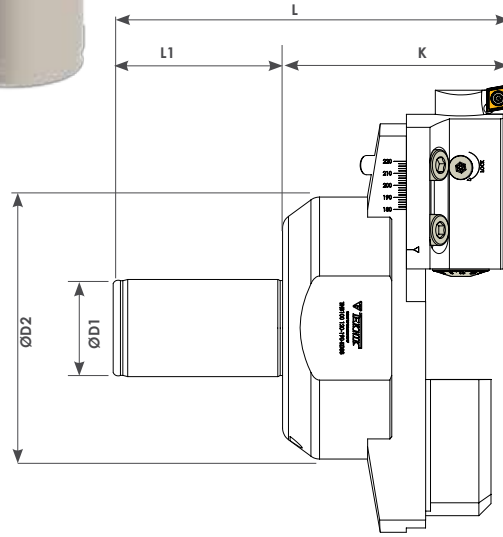
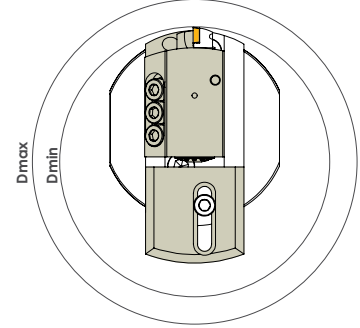

**HASSASİYET**  
Fine / Fein

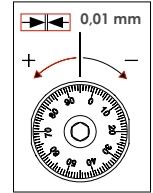

Sipariş Kodu Order Code Best.-Nr.	Stok/Stock/Lager	Ürün Kodu Product Code Produkt-Code	Ölçüler (mm) Dimensions (mm) Abmessungen (mm)							Kullanılan Uç Insert WSP	HASSASİYET Fine Fein
			Dmin	Dmax	K	ØD1	L1	ØD2	L		
THB100	●	120-190 K093 CC--09	120	190	93	40	70	109,5	163	CC -- 09T3	0,01
THB101	●	180-240 K093 CC--09	180	240	93	40	70	109,5	163		
THB102	●	240-300 K093 CC--09	240	300	93	40	70	109,5	163		

● Stokta/ In Stock / Lager ○ Sınırlı Stok / Limited Stock / Begrenzte Lagerhaltung

**تکنیک تولز**  
ابزار آلات صنعتی ، تراشکاری و قالبسازی  
۶۶۷۱۷۲۹ - ۶۶۷۱۱۹۶۷  
تهران، خ امام خمینی، م حسن آباد، پاساژ هشت گنبد، شماره ۱۵



# 120-300 mm Finiş Bara

120-300 mm Boring Tools Finish

120-300 mm Ausdrehwerkzeug für die Fertigbearbeitung



Technical solution for quality

Kalite için TEKNİK çözüm

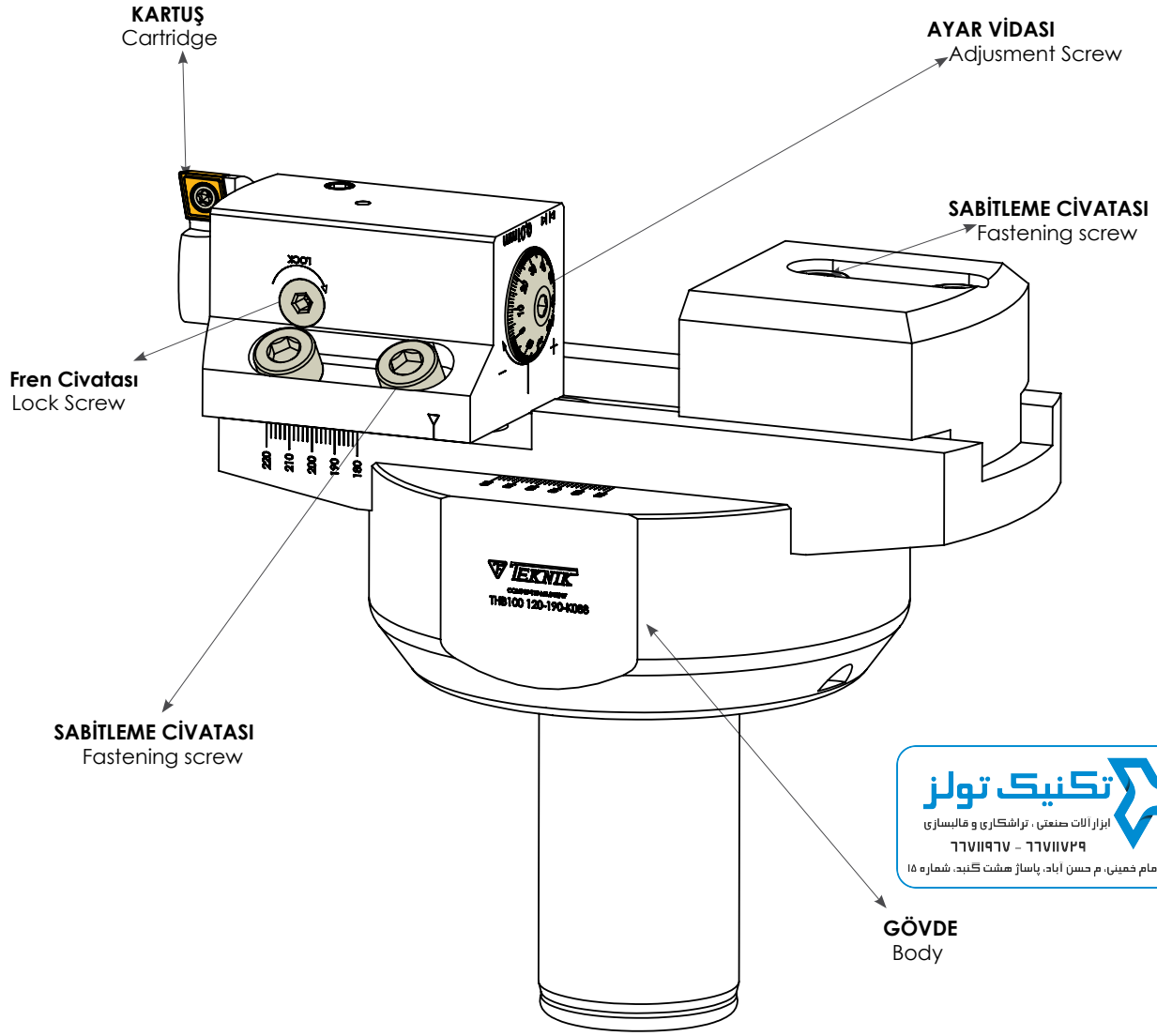

Dmin-Dmax	Kartuşlar Cartridges Kartusche	Kullanılan Uç Insert WSP	Sıkma Cıvatası Clamp Screw Torx-Schraube	Sabitleme Cıvatası Locking Screw Verriegelungs Schraube	Ayar Cıvatası Adjustment Screw Einstellschraube	Anahtar Torx Key Torx-Schlüssel	
120-190	KR154	CC--09T3	TC067 M3,5x8,5	TC108-M8x30	SK42-M8x30	PC23-M8x46	T15
180-240	KR154	CC--09T3	TC067 M3,5x8,5	TC108-M8x30	SK42-M8x30	PC23-M8x46	T15
240-300	KR154	CC--09T3	TC067 M3,5x8,5	TC108-M8x30	SK42-M8x30	PC23-M8x46	T15

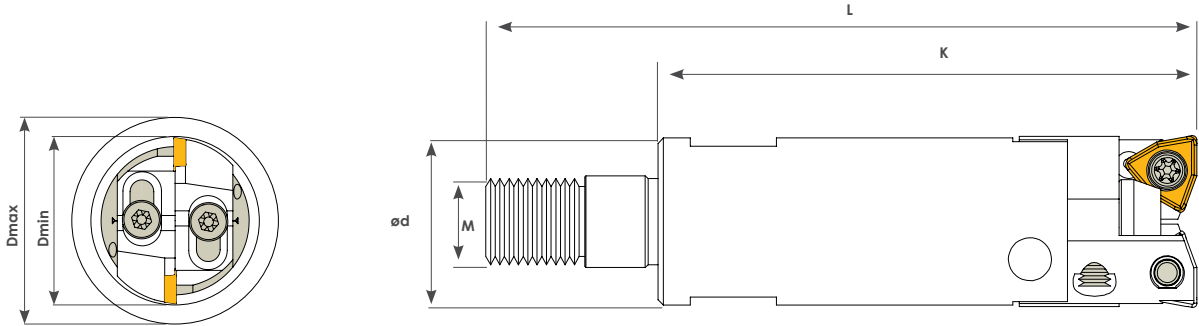

**تکنیک تولز**

ابزار آلات صنعتی، تراشکاری و ماشینکاری

۶۶۷۱۱۶۷ - ۶۶۷۱۱۶۹

تهران، خ امام خمینی، م حسن آباد، پاساژ هشت گنبد، شماره ۱۵

Sipariş Kodu Order Code Best.-Nr.	Stok/Stock/Lager	Ürün Kodu Product Code Produkt-Code	Ölçüler (mm) Dimensions (mm) Abmessungen (mm)						Kullanılan Uç Insert WSP
			Dmin	Dmax	M	K	L	ød	
TKB170	●	16-20 K050 M8 WC--03	16	20	M8	50	66	15	WC-- 0302
TKB172	●	19-23 K050 M10 CC--06	19	23	M10	50	70	17	CC -- 0602
TKB174	●	23-28 K050 M12 CC--06	23	28	M12	50	72	21	
TKB176	●	28-38 K050 M16 CC--09	28	38	M16	50	74,5	25	CC -- 09T3

● Stokta / In Stock / Lager ○ Sınırlı Stok / Limited Stock / Begrenzte Lagerhaltung

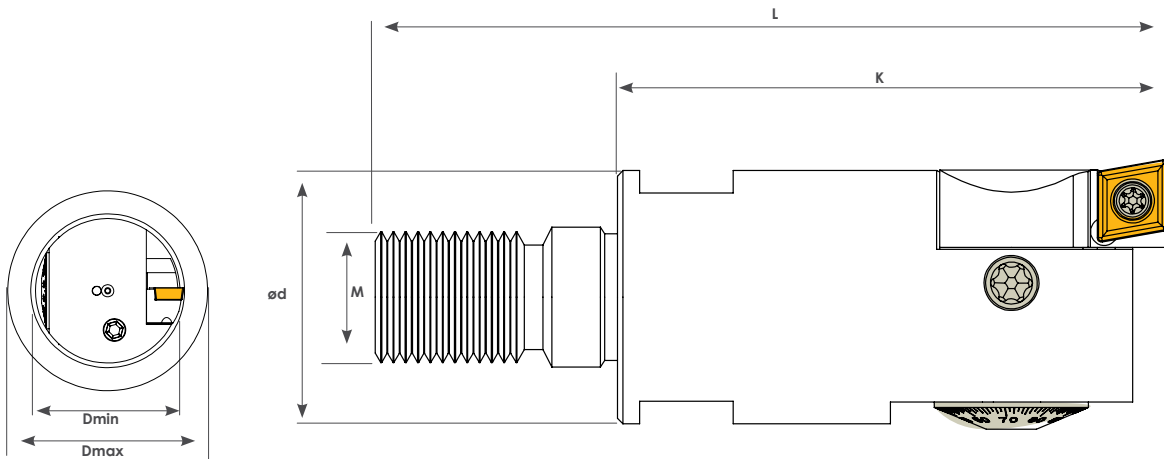

Sipariş Kodu Order Code Best.-Nr.	Stok/Stock/Lager	Ürün Kodu Product Code Produkt-Code	Ölçüler (mm) Dimensions(mm) Abmessungen (mm)						Kullanılan Uç Insert WSP	HASSASİYET Fine Fein
			Dmin	Dmax	M	K	L	ød		
THKB102	●	25-32 K050 M12 CC--06	25	32	M12	50	72	23	 CC -- 0602	0,02
THKB104	●	32-40 K050 M16 CC--06	32	40	M16	50	74	29	CC -- 0602	0,01

● Stokta / In Stock / Lager ○ Sınırlı Stok / Limited Stock / Begrenzte Lagerhaltung

**تکنیک تولز**  
ابزار آلات صنعتی، تراشکاری و قالبسازی  
۶۶۷۱۱۶۶ - ۶۶۷۱۱۶۶  
تهران، خ امام خمینی، م حسن آباد، پاساژ هشت گنبد، شماره ۱۵



**Helis ve Disk Frezeler**  
Shoulder Miller & Disc Milling  
Içelfräser & Scheibenfräsen

## H1 APKT 1604

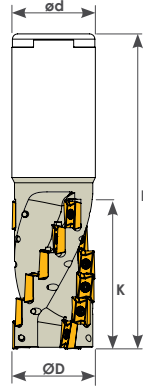
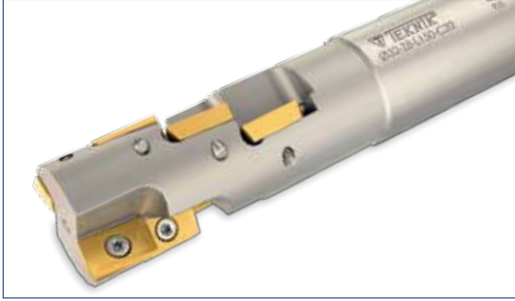

Ölçüler (mm) Dimensions(mm) Abmessungen (mm)		APKT 1604	
L	S		
16,40	4,76		

Sipariş Kodu Order Code Best.-Nr.	Stok/Stock/Lager	Ürün Kodu Product Code Produkt-Code	Ölçüler (mm) Dimensions(mm) Abmessungen (mm)					Kullanılan Uç Insert WSP	Sıkma Cıvatası Clamp Screw Torx-Schraube	Anahtar Torx Key Torx-Schlüssel
			ØD	Z	K	ød	L			
HF20	●	D32 Z06 K45 AP--16	32	6	45	32	125	AP-- 1604 KRLY	TC074 M4x10	T15
HF22	●	D40 Z09 K45 AP--16	40	9	45	32	125			
HF24	●	D32 Z08 K60 AP--16	32	8	60	32	150			
HF26	●	D40 Z12 K60 AP--16	40	12	60	32	150			
HF30	●	D32 Z08 K60 AP--16	32	8	60	32	200			
HF32	●	D40 Z12 K60 AP--16	40	12	60	32	200			

KRLY ucuna uygundur. / Compatible with KRLY insert. / Kompatibel für KRLY WP

## H2 APKT 1003

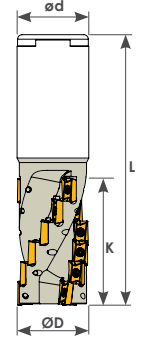

Ölçüler (mm) Dimensions(mm) Abmessungen (mm)		APKT 1003	
L	S		
10,05	3,52		

Sipariş Kodu Order Code Best.-Nr.	Stok/Stock/Lager	Ürün Kodu Product Code Produkt-Code	Ölçüler (mm) Dimensions(mm) Abmessungen (mm)					Kullanılan Uç Insert WSP	Sıkma Cıvatası Clamp Screw Torx-Schraube	Anahtar Torx Key Torx-Schlüssel
			ØD	Z	K	ød	L			
HF06	●	D20 Z06 K28 AP--10	20	6	28	20	120	AP-- 1003 KRLY	TC060 M2,5x5,5	T08
HF07	●	D25 Z08 K49 AP--10	25	8	49	25	120			
HF08	●	D32 Z15 K57 AP--10	32	15	57	32	120			
HF09	●	D40 Z18 K57 AP--10	40	18	57	32	125			
HF10	●	D20 Z06 K28 AP--10	20	6	28	20	150			
HF11	●	D25 Z08 K49 AP--10	25	8	49	25	150			
HF12	●	D32 Z15 K57 AP--10	32	15	57	32	150			
HF13	●	D40 Z18 K56 AP--10	40	18	56	32	150			
HF15	●	D20 Z06 K28 AP--10	20	6	28	20	200			
HF16	●	D25 Z08 K49 AP--10	25	8	49	25	200			
HF17	●	D32 Z15 K57 AP--10	32	15	57	32	200			
HF18	●	D40 Z18 K56 AP--10	40	18	56	32	200			

● Stokta / In Stock / Lager ○ Sınırlı Stok / Limited Stock / Begrenzte Lagerhaltung  
KRLY ucuna uygundur. / Compatible with KRLY insert. / Kompatibel für KRLY WP

**TEKNİK TOLUN**  
ابزار آلات صنعتی، تراشکاری و ماشینکاری  
تهران، خ امام خمینی، م حسن آباد، پاساژ هشت گنبد، شماره 15  
۶۶۷۱۱۶۶ - ۶۶۷۱۱۶۹

**H4  
APKT 1604**

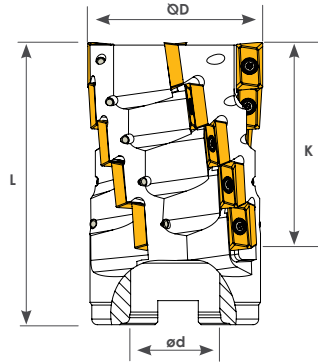

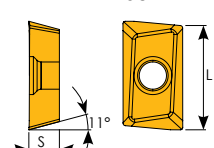
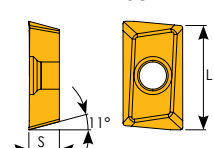
Ölçüler (mm) Dimensions (mm) Abmessungen (mm)		APKT 1604	
L	S		
16,4	4,76		

Sipariş Kodu Order Code Best.-Nr.	Stok/Stock/Lager	Ürün Kodu Product Code Produkt-Code	Ölçüler (mm) Dimensions (mm) Abmessungen (mm)					Kullanılan Uç Insert WSP	Sıkma Civatası Clamp Screw Torx-Schraube	Anahtar Torx Key Torx-Schlüssel
			ØD	Z	K	ød	L			
HF52	●	D63 Z20 K75 AP--16	63	20	75	32	100	AP-- 1604 KRLY	TC074 M4x10	T15
HF53	●	D80 Z25 K75 AP--16	80	25	75	32	100			
HF54	○	D100 Z30 K75 AP--16	100	30	75	40	100			

● Stokta/ In Stock / Lager ○ Sınırlı Stok / Limited Stock / Begrenzte Lagerhaltung  
KRLY ucuna uygundur. / Compatible with KRLY insert. / Kompatible für KRLY WP

## SCMT 09T3-1204

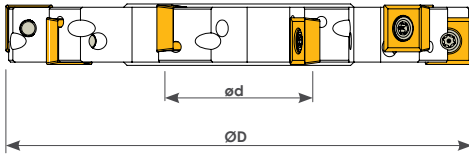

Ölçüler (mm) Dimensions (mm) Abmessungen (mm)		SCMT 09T3		SCMT 1204	
L	S	9,52	3,97	12,7	4,97

Sipariş Kodu Order Code Best.-Nr.	Stok/Stock/Lager	Ürün Kodu Product Code Produkt-Code	Ölçüler (mm) Dimensions (mm) Abmessungen (mm)					Kullanılan Uç Insert WSP	Sıkma Civatası Clamp Screw Torx-Schraube	Anahtar Torx Key Torx-Schlüssel
			ØD	A	Z	ød	Ap			
DF086	●	D080 A10 Z08 SC--09	80	10	8	27	11	SCMT 09T3 ISO	TC079 M4x11	T15
DF092	●	D100 A10 Z08 SC--09	100	10	8	32	24			
DF100	●	D125 A10 Z10 SC--09	125	10	10	40	32			
DF108	●	D160 A10 Z12 SC--09	160	10	12	40	50			
DF116	●	D200 A10 Z14 SC--09	200	10	14	40	65			
DF088	●	D080 A12 Z08 SC--09	80	12	8	27	11			
DF094	●	D100 A12 Z08 SC--09	100	12	8	32	24			
DF102	●	D125 A12 Z10 SC--09	125	12	10	40	32			
DF110	●	D160 A12 Z12 SC--09	160	12	12	40	50			
DF118	●	D200 A12 Z14 SC--09	200	12	14	40	65			
DF090	●	D080 A16 Z08 SC--12	80	16	8	27	11	SCMT 1204 ISO	TC083 M5x12	T20
DF096	●	D100 A16 Z08 SC--12	100	16	8	32	24			
DF104	●	D125 A16 Z10 SC--12	125	16	10	40	32			
DF112	●	D160 A16 Z12 SC--12	160	16	12	40	50			
DF120	●	D200 A16 Z14 SC--12	200	16	14	40	65			
DF106	●	D125 A20 Z10 SC--12	125	20	10	40	32			
DF114	●	D160 A20 Z12 SC--12	160	20	12	40	50			

● Stokta/ In Stock / Lager ○ Sınırlı Stok / Limited Stock / Begrenzte Lagerhaltung  
SCMT 09T3-1204 ISO'dur. / SCMT 09T3-1204 is ISO. / Kompatible für ISO WP

## SPMG 0904-1104

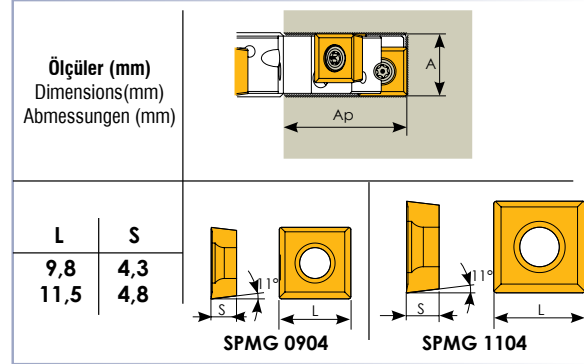
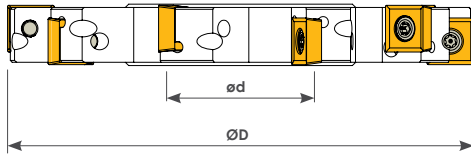
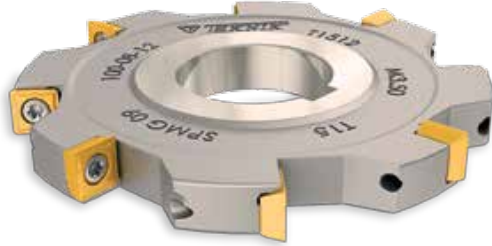

Sipariş Kodu Order Code Best.-Nr.	Stok/Stock/Lager	Ürün Kodu Product Code Produkt-Code	Ölçüler (mm) Dimensions(mm) Abmessungen (mm)					Kullanılan Uç Insert WSP	Sıkma Cıvatası Clamp Screw Torx-Schraube	Anahtar Torx Key Torx-Schlüssel
			ØD	A	Z	ød	Ap			
DF130	○	D100 A12 Z08 SP--09	100	12	8	32	24	SPMG 0904	TC067 M3,5x9	T15
DF132	○	D100 A16 Z08 SP--09	100	16	8	32	24	TGTC		
DF134	○	D100 A20 Z08 SP--11	100	20	8	32	24	SPMG 1104 TGTC	TC074 M4x10	
DF136	○	D100 A13,5 Z08 SP--09	100	13,5	8	32	24	SPMG 0904 TGTC	TC067 M3,5x9	
DF137	○	D100 A15,5 Z08 SP--11	100	15,5	8	32	24	SPMG 1104	TC074 M4x10	
DF138	○	D100 A20,5 Z08 SP--11	100	20,5	8	32	24	TGTC		

● Stokta / In Stock / Lager ○ Sınırlı Stok / Limited Stock / Begrenzte Lagerhaltung  
TGTCucuna uygundur. / Compatible with TGTCinsert. / Kompatible für TGTCWP

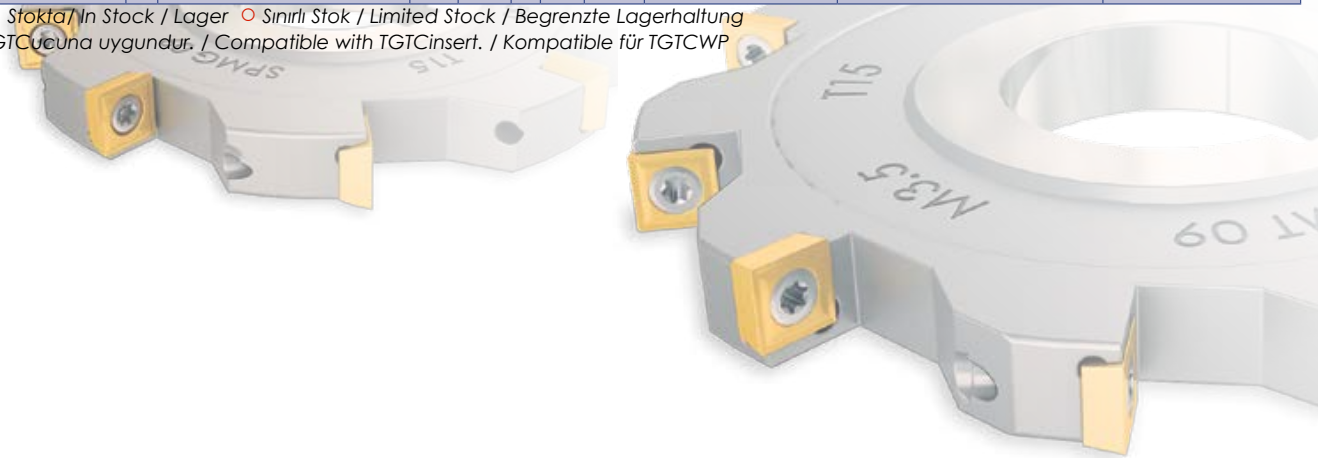



## CCMT 0602-09T3-1204

تکنیک تولز  
ابزار آلات صنعتی، تراشکاری و ماشینکاری  
۶۶۷۱۷۲۹ - ۶۶۷۱۹۶۷  
تهران، خ امام خمینی، م حسن آباد، پاساژ هشت گنبد، شماره ۱۵

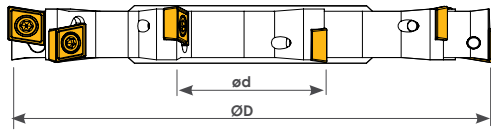

Ölçüler (mm) Dimensions (mm) Abmessungen (mm)				
L	S			
6,2	2,38			
9,4	3,97			
12,4	4,76			

Sipariş Kodu Order Code Best.-Nr.	Stok/Stock/Lager	Ürün Kodu Product Code Produkt-Code	Ölçüler (mm) Dimensions (mm) Abmessungen (mm)						Kullanılan Uç Insert WSP	Sıkma Cıvatası Clamp Screw Torx-Schraube	Anahtar Torx Key Torx-Schlüssel
			øD	A	Z	ød	Ap				
DF150	●	D080 A08 Z10 CC--06	80	8	10	27	11	CCMT 0602 ISO	TC063 M2,5x7	T08	
DF160	●	D100 A08 Z12 CC--06	100	8	12	32	24				
DF170	●	D125 A08 Z14 CC--06	125	8	14	40	32				
DF182	●	D160 A08 Z16 CC--06	160	8	16	40	50				
DF194	●	D200 A08 Z18 CC--06	200	8	18	40	65				
DF152	●	D080 A10 Z10 CC--06	80	10	10	27	11				
DF162	●	D100 A10 Z12 CC--06	100	10	12	32	24				
DF172	●	D125 A10 Z14 CC--06	125	10	14	40	32				
DF184	●	D160 A10 Z16 CC--06	160	10	16	40	50				
DF196	●	D200 A10 Z18 CC--06	200	10	18	40	65				
DF154	●	D080 A12 Z08 CC--09	80	12	8	27	11	CCMT 09T3 ISO	TC067 M3,5x9	T15	
DF164	●	D100 A12 Z10 CC--09	100	12	10	32	24				
DF174	●	D125 A12 Z12 CC--09	125	12	12	40	32				
DF186	●	D160 A12 Z14 CC--09	160	12	14	40	50				
DF198	●	D200 A12 Z16 CC--09	200	12	16	40	65				
DF156	●	D080 A14 Z08 CC--09	80	14	8	27	11				
DF166	●	D100 A14 Z10 CC--09	100	14	10	32	24				
DF176	●	D125 A14 Z12 CC--09	125	14	12	40	32				
DF188	●	D160 A14 Z14 CC--09	160	14	14	40	50				
DF200	●	D200 A14 Z16 CC--09	200	14	16	40	65				
DF158	●	D080 A16 Z06 CC--12	80	16	6	27	11	CCMT 1204 ISO	TC083 M5x12	T20	
DF168	●	D100 A16 Z08 CC--12	100	16	8	32	24				
DF178	●	D125 A16 Z10 CC--12	125	16	10	40	32				
DF190	●	D160 A16 Z12 CC--12	160	16	12	40	50				
DF180	●	D125 A20 Z10 CC--12	125	20	10	40	32				
DF192	●	D160 A20 Z12 CC--12	160	20	12	40	50				



تکنیک تولز

ابزار آلات صنعتی ، تراشکاری و ماشینکاری

۶۶۷۱۱۶۶ - ۶۶۷۱۱۶۶

تهران، خ امام خمینی، م حسن آباد، پاساژ هشت گنبد، شماره ۱۵

**T Kanal Freze**  
T-Slot Milling Cutter  
T- Nutenfräser

## CCMT 0602-09T3-1204 T KANAL FREZE

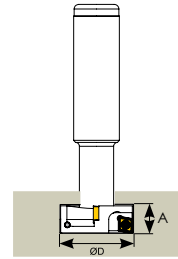
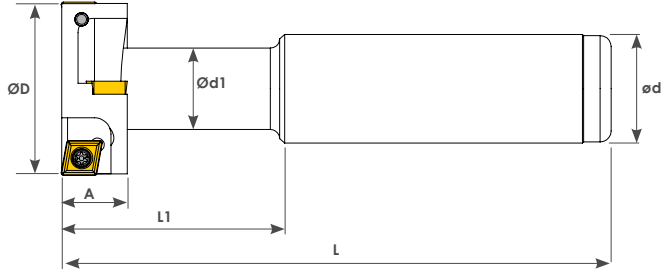

Sipariş Kodu Order Code Best.-Nr.	Stok/Stock/Lager	Ürün Kodu Product Code Produkt-Code	Ölçüler (mm) Dimensions (mm) Abmessungen (mm)							Kullanılan Uç Insert WSP	Sıkma Cıvatası Clamp Screw Torx-Schraube	Anahtar Torx Key Torx-Schlüssel
			ØD	A	Z	ød	ød1	L	L1			
TKÇ096	●	D17 A08 Z02 CC--06	17	8	2	16	10	100	30	CCMT 0602 ISO	TC060 M2,5x5,5	T8
TKÇ098	●	D21 A09 Z02 CC--06	21	9	2	16	11	100	30			
TKÇ100	●	D25 A11 Z04 CC--06	25	11	4	20	15	100	30			
TKÇ102	●	D32 A12 Z04 CC--06	32	12	4	20	15	100	40			
TKÇ104	●	D35 A15 Z04 CC--09	35	15	4	25	14	100	50	CCMT 09T3 ISO	TC067 M3,5x9	T15
TKÇ106	●	D40 A17 Z04 CC--09	40	17	4	25	20	110	50			
TKÇ108	●	D50 A20 Z04 CC--12	50	20	4	32	26	110	50	CCMT 1204 ISO	TC083 M5x12	T20
TKÇ120	●	D63 A09 Z08 CC--06	63	9	8	32	20	125	37	CCMT 0602 ISO	TC060 M2,5x5,5	T8
TKÇ122	●	D80 A09 Z10 CC--06	80	9	10	32	32	120	-			

● Stokta/ In Stock / Lager ○ Sınırlı Stok / Limited Stock / Begrenzte Lagerhaltung  
CCMT 0602-09T3-1204 ISO'dur./ CCMT 0602-09T3-1204 is ISO. / Kompatible für ISO WP

Ölçüler (mm) Dimensions (mm) Abmessungen (mm)		CCMT 0602	
L	S		
6,2	2,38		

Ölçüler (mm) Dimensions (mm) Abmessungen (mm)		CCMT 09T3	
L	S		
9,4	3,97		

Ölçüler (mm) Dimensions (mm) Abmessungen (mm)		CCMT 1204	
L	S		
12,4	4,76		

تکنیک تولز

ابزار آلات صنعتی، تراشکاری و ماشینکاری  
۶۶۷۱۱۶۶۷ - ۶۶۷۱۱۶۶۹  
تهران، خ امام خمینی، م حسن آباد، پاساژ هشت گنبد، شماره ۱۵

**S39**  
**SPMG 05-06-07 T KANAL FREZE**

**تکنیک تولز**

ابزار آلات صنعتی، تراشکاری و ماشینکاری  
۶۶۷۱۱۹۶۷ - ۶۶۷۱۱۷۲۹  
تهران، خ امام خمینی، م حسن آباد، پاساژ هشت کتب، شماره ۱۵

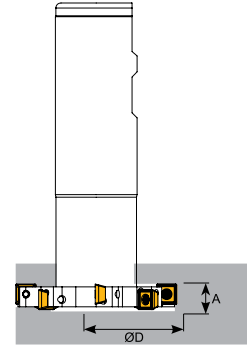
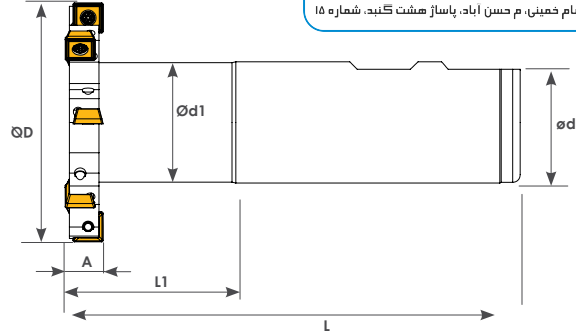

Sipariş Kodu Order Code Best.-Nr.	Stok/Stock/Lager	Ürün Kodu Product Code Produkt-Code	Ölçüler (mm) Dimensions(mm) Abmessungen (mm)						Kullanılan Uç Insert WSP	Sıkma Cıvatası Clamp Screw Torx-Schraube	Anahtar Torx Key Torx-Schlüssel	
			ØD	A	Z	ød	ød1	L				L1
TKÇ050	●	D50 A05 Z07 SP--05	50	5	7	32	31,5	120	45	SPMG 05 TGTC	TC058 M2x4,2	T6
TKÇ052	●	D63 A05 Z08 SP--05	63	5	8	32	31,5	120	45	SPMG 06 TGTC	TC059 M2,2x5	T7
TKÇ054	●	D50 A06 Z07 SP--06	50	6	7	32	31,5	120	45			
TKÇ056	●	D63 A06 Z08 SP--06	63	6	8	32	31,5	120	45			
TKÇ058	●	D80 A06 Z10 SP--06	80	6	10	32	31,5	120	45			
TKÇ060	●	D50 A08 Z06 SP--06	50	8	6	32	31,5	120	45	SPMG 07 TGTC	TC063 M2,5x7	T8
TKÇ062	●	D63A08 Z08 SP--06	63	8	8	32	31,5	120	45			
TKÇ064	●	D80 A08 Z10 SP--06	80	8	10	32	31,5	120	45			
TKÇ066	●	D50 A10 Z06 SP--07	50	10	6	32	31,5	120	45			
TKÇ068	●	D63 A10 Z08 SP--07	63	10	8	32	31,5	120	45			
TKÇ070	●	D80 A10 Z10 SP--07	80	10	10	32	31,5	120	45			

● Stokta / In Stock / Lager ○ Sınırlı Stok / Limited Stock / Begrenzte Lagerhaltung  
TGTCucuna uygundur. / Compatible with TGTCinsert. / Kompatible für TGTCWP

Ölçüler (mm) Dimensions(mm) Abmessungen (mm)		SPMG 05	
L	S		
5	2,38		

Ölçüler (mm) Dimensions(mm) Abmessungen (mm)		SPMG 06	
L	S		
6	2,38		

Ölçüler (mm) Dimensions(mm) Abmessungen (mm)		SPMG 07	
L	S		
7,94	3,97		

## S46 DAIRE KANAL TAKIMI

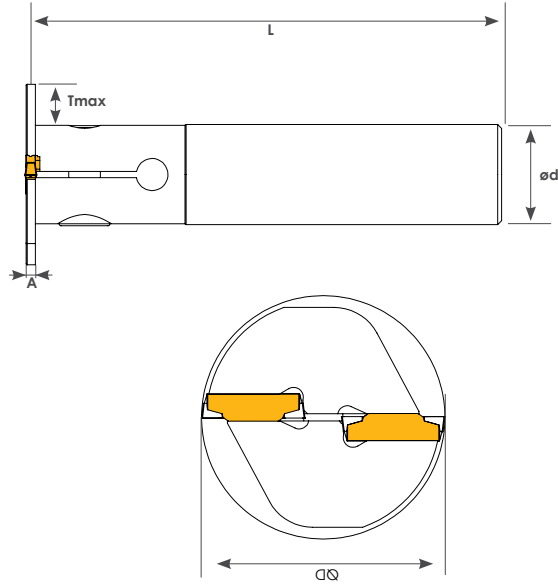

Sipariş Kodu Order Code Best.-Nr.	Stok/Stock/Lager	Ürün Kodu Product Code Produkt-Code	Ölçüler (mm) Dimensions(mm) Abmessungen (mm)						Kullanılan Uç Insert WSP	Sıkma Civatası Clamp Screw Torx-Schraube	Anahtar Torx Key Torx-Schlüssel
			ØD	A	Z	L	ød	Tmax			
TKÇ300	●	D50 A03 Z02 L-120	50	3	2	120	25	12,5	MGM 3C KRLY	M8	6 Allen
TKÇ301	●	D63 A03 Z02 L-120	63	3	2	120	25	19			
TKÇ302	●	D80 A03 Z02 L-120	80	3	2	120	32	24			
TKÇ303	●	D50 A04 Z02 L-120	50	4	2	120	25	12	MGM 4C KRLY	M8	6 Allen
TKÇ304	●	D63 A04 Z02 L-120	63	4	2	120	25	19			
TKÇ305	●	D80 A04 Z02 L-120	80	4	2	120	32	24			
TKÇ306	●	D55 A05 Z02 L-120	55	5	2	120	25	15	MGM 5C KRLY	M8	6 Allen
TKÇ307	●	D63 A05 Z02 L-120	63	5	2	120	25	19			
TKÇ308	●	D80 A05 Z02 L-120	80	5	2	120	32	24			

● Stokta / In Stock / Lager ○ Sınırlı Stok / Limited Stock / Begrenzte Lagerhaltung  
KRLY ucuna uygundur. / Compatible with KRLY insert. / Kompatible für KRLY WP



## TCMT 1102 16T3 HAVŞA Chamfering end Milling

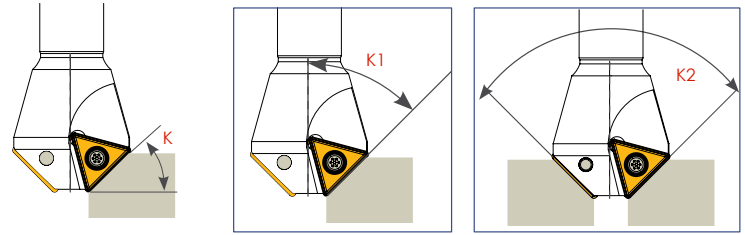
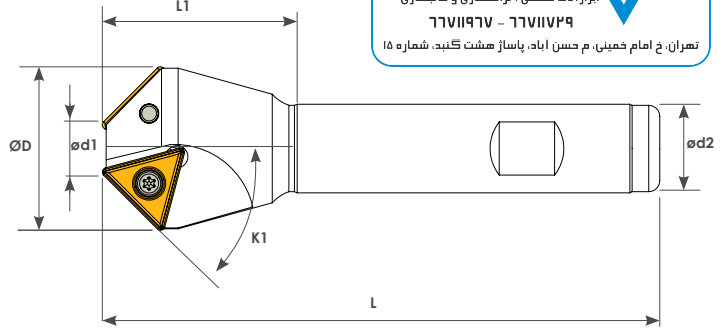

Ölçüler (mm)  
Dimensions (mm)  
Abmessungen (mm)

TCMT 1102

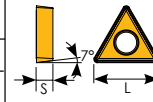

L  
11

S  
2,38

Ölçüler (mm)  
Dimensions (mm)  
Abmessungen (mm)

TCMT 16T3

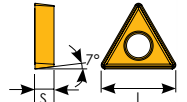

L  
16,6

S  
3,97

Sipariş Kodu Order Code Best.-Nr.	Stok/Stock/Lager	Ürün Kodu Product Code Produkt-Code	Ölçüler (mm) Dimensions (mm) Abmessungen (mm)									Kullanılan Uç Insert WSP	Sıkma Civatası Clamp Screw Torx-Schraube	Anahtar Torx Key Torx-Schlüssel
			ød1	ØD	Z	K	K1	K2	ød2	L	L1			
S335	●	02-18 Z01 K30° TC--11	2	18	1	30°	60°	120°	16	100	35	TCMT 1102 ISO	TC060 M2,5x5,5	T8
S334	●	04-16 Z01 K45° TC--11	4	16	1	45°	45°	90°	16	100	35			
S339	●	10-31 Z02 K30° TC--16	10	31	2	30°	60°	120°	16	100	35	TCMT 16T3 ISO	TC067 M3,5x9	T15
S336	●	10-31 Z02 K45° TC--16	10	31	2	45°	45°	90°	16	100	35			
S338	●	14-35 Z02 K45° TC--16	14	35	2	45°	45°	90°	20	100	35			
S340	●	22-43 Z03 K45° TC--16	22	43	3	45°	45°	90°	25	100	35			
S342	●	32-53 Z03 K45° TC--16	32	53	3	45°	45°	90°	25	100	35			
S343	●	24-39 Z02 K60° TC--16	24	39	2	60°	30°	60°	20	100	35			
S345	●	10-34 Z02 K60° TC--16	10	34	2	60°	30°	60°	20	100	35			

● Stokta / In Stock / Lager ○ Sınırlı Stok / Limited Stock / Begrenzte Lagerhaltung  
TCMT 1102-16T3 ISO'dur. / TCMT 11T3-16T3 is ISO. / Kompatible für ISO WP

T32

**APKT 16 HAVŞA**  
Chamfering end Milling

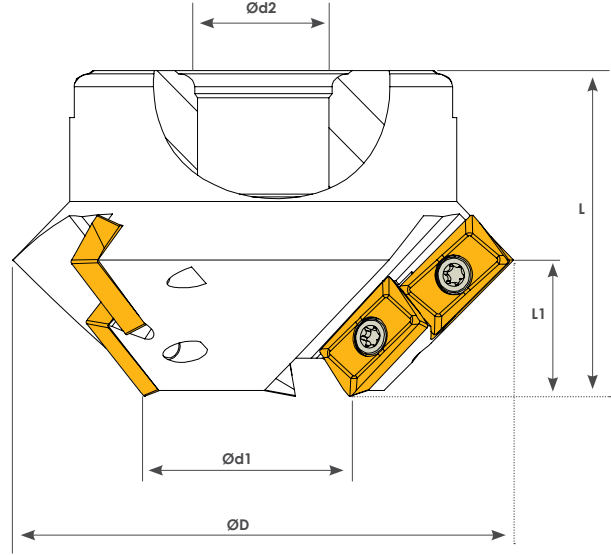

Ölçüler (mm) Dimensions (mm) Abmessungen (mm)		AP-- 1604	
L	S		
16,40	4,76		

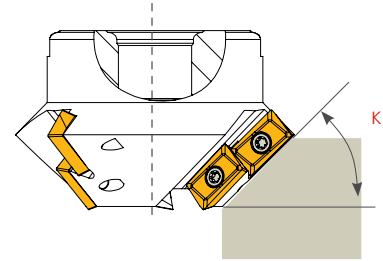
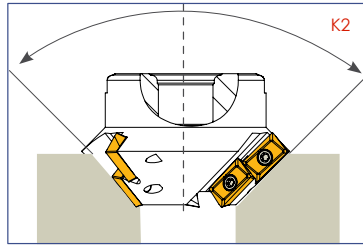
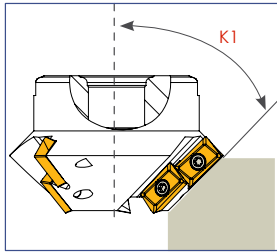

Sipariş Kodu Order Code Best.-Nr.	Stok/Stock/Lager	Ürün Kodu Product Code Produkt-Code	Ölçüler (mm) Dimensions (mm) Abmessungen (mm)										Kullanılan Uç Insert WSP	Sıkma Cıvatası Clamp Screw Torx-Schraube	Anahtar Torx Key Torx-Schlüssel
			Ød1	ØD	Z	K	K1	K2	Ød2	Ød3	L	L1			
T455	●	35-86 Z06 K30° AP--16	35	86	6	30°	60°	120°	27	60	50	15	AP-- 1604 KRLY	TC074 M4x10	T15
T456	●	35-76 Z06 K45° AP--16	35	76	6	45°	45°	90°	27	60	50	21,5			
T457	●	35-50,5 Z06 K75° AP--16	35	50,5	6	75°	15°	30°	22	45	60	30			
T458	●	35-94 Z06 K15° AP--16	35	94	6	15°	75°	150°	27	60	50	8,5			

## Arka Yüzey Frezeleme Back Facing Milling Cutters

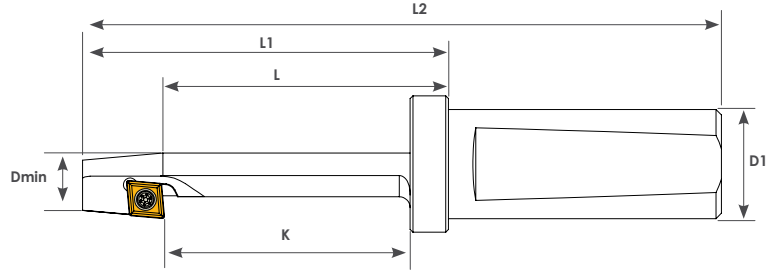
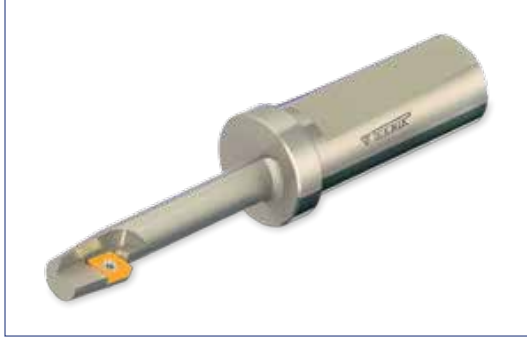

Sipariş Kodu Order Code Best.-Nr.	Stok/Stock/Lager	Ürün Kodu Product Code Produkt-Code	Ölçüler (mm) Dimensions(mm) Abmessungen (mm)							Kullanılan Uç Insert WSP	Sıkma Cıvatası Clamp Screw Torx-Schraube	Anahtar Torx Key Torx-Schlüssel
			ØD	Dmin	K	L	L1	L2	D1			
C100	●	D18-K40 CC--06	18	10	40	47	60	110	20	CCMT 060204 ISO	TC060 M2,5x5	T08
C102	●	D20-K45 CC--06	20	12	45	52	67	117	20			
C104	●	D26-K60 CC--06	26	17	60	67	82	132	20			
C106	●	D33-K75 CC--09	33	21	75	82	102	152	20	CCMT 09T304 ISO	TC067 M3,5x9	T15

● Stokta/ In Stock / Lager ○ Sınırlı Stok / Limited Stock / Begrenzte Lagerhaltung  
CCMT 0602-09T3-1204 ISO'dur. / CCMT 0602-09T3-1204 is ISO. / Kompatible für ISO WP

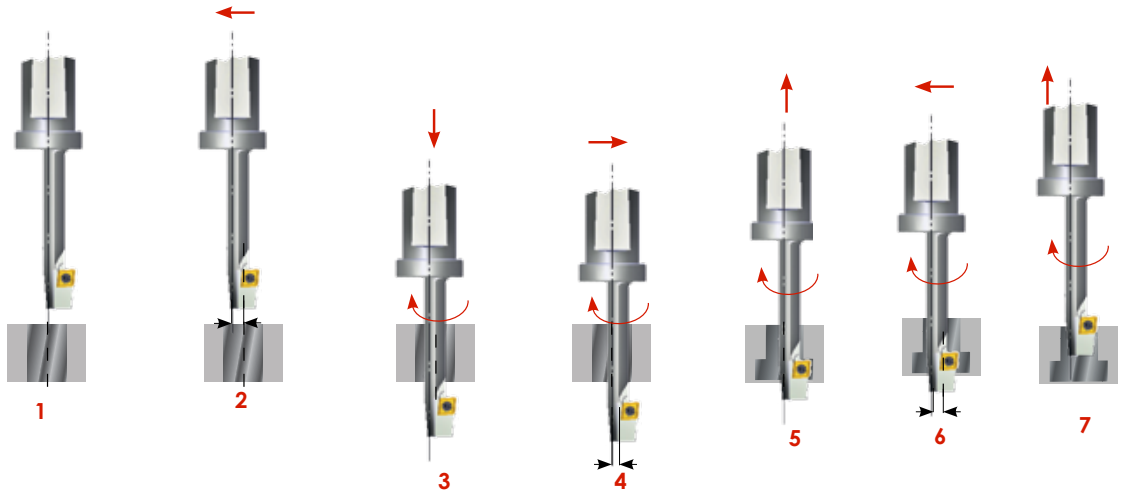



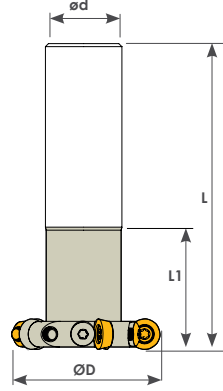

## S51 RHKW 1003

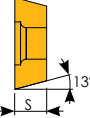
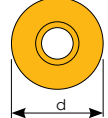

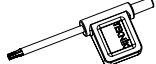

Ölçüler (mm) Dimensions (mm) Abmessungen (mm)		RHKW 1003	
d	S		
10	3,80		

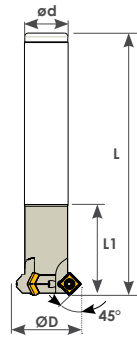

Sipariş Kodu Order Code Best.-Nr.	Stok/Stock/Lager	Ürün Kodu Product Code Produkt-Code	Ölçüler (mm) Dimensions (mm) Abmessungen (mm)					Kullanılan Uç Insert WSP	Sıkma Cıvatası Clamp Screw Torx-Schraube	Baskı Cıvatası Locking Screw Verriegelungs Schraube	Anahtar Torx Key Torx-Schlüssel
			ØD	Z	L	ød	L1				
TKÇ200	●	D40 Z04 L100 RH--10	40	4	100	20	40				
TKÇ202	●	D50 Z05 L120 RH--10	50	5	120	25	40	RHKW 1003 INGRSLL	TC074 M4x10	TC040 M3,5	T15

INGRSLL ucuna uygundur. / Compatible with INGRSLL insert. / Kompatible für INGRSLL WP

## S52 45° SPMG 0904

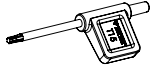

Ölçüler (mm) Dimensions (mm) Abmessungen (mm)		SPMG 0904	
L	S		
9,8	4,3		

Sipariş Kodu Order Code Best.-Nr.	Stok/Stock/Lager	Ürün Kodu Product Code Produkt-Code	Ölçüler (mm) Dimensions (mm) Abmessungen (mm)					Kullanılan Uç Insert WSP	Sıkma Cıvatası Clamp Screw Torx-Schraube	Anahtar Torx Key Torx-Schlüssel
			ØD	Z	L	ød	L1			
S060	●	D32 Z02 L150 SP--09	32	2	150	25	30			
S062	●	D40 Z03 L150 SP--09	40	3	150	25	50	SPMG 0904 TGTC	TC067 M3,5x9	T15

● Stokta / In Stock / Lager ○ Sınırlı Stok / Limited Stock / Begrenzte Lagerhaltung  
TGTCucuna uygundur. / Compatible with TGTCinsert. / Kompatible für TGTCWP

## 55° DCMT 11T3-35° VBMT 1604

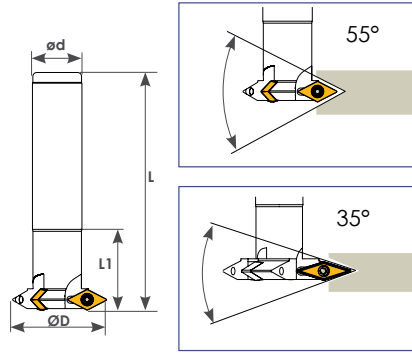

Ölçüler (mm) Dimensions (mm) Abmessungen (mm)		DCMT 11T3
L	S	
11,3	3,97	
15,3	4,76	
		VBMT 1604

Sipariş Kodu Order Code Best.-Nr.	Stok/Stock/Lager	Ürün Kodu Product Code Produkt-Code	Ölçüler (mm) Dimensions (mm) Abmessungen (mm)					Kullanılan Uç Insert WSP	Sıkma Cıvatası Clamp Screw Torx-Schraube	Anahtar Torx Key Torx-Schlüssel
			ØD	Z	L	ød	L1			
S070	●	D50 Z03 L120-DC--11	50	3	120	25	40	DCMT 11T3	TC067	T15
S072	●	D63 Z04 L120-DC--11	63	4	120	25	40	ISO	M3.5X8,5	T15
S073	●	D75 Z03 L130-VB--16	75	3	130	25	40	VBMT 1604 ISO	TC074 M4x10	T15

DCMT 11T3 ISO'dur./ DCMT 11T3 is ISO. / Kompatible für ISO WP

## 60° DCMT 11T3

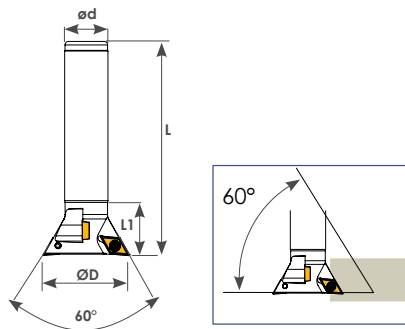

Ölçüler (mm) Dimensions (mm) Abmessungen (mm)		DCMT 11T3
L	S	
11,3	3,97	

Sipariş Kodu Order Code Best.-Nr.	Stok/Stock/Lager	Ürün Kodu Product Code Produkt-Code	Ölçüler (mm) Dimensions (mm) Abmessungen (mm)					Kullanılan Uç Insert WSP	Sıkma Cıvatası Clamp Screw Torx-Schraube	Anahtar Torx Key Torx-Schlüssel
			ØD	Z	L	ød	L1			
TKÇ 250	●	D050 Z04 L120 DC--11	50	4	120	25	30	DCMT 11T3	TC067	T15
								ISO	M3.5X9	T15

● Stokta/ In Stock / Lager ○ Sınırlı Stok / Limited Stock / Begrenzte Lagerhaltung

DCMT 11T3 ISO'dur./ DCMT 11T3 is ISO. / Kompatible für ISO WP



**تکنیک تولز**

ابزار آلات صنعتی ، تراشکاری و ماشینکاری  
۶۶۷۱۱۶۶ - ۶۶۷۱۱۶۹

تهران، خ امام خمینی، م حسن ایاد، پاساژ هشت گنبد، شماره ۱۵



**Saplı Tarama**  
End Mill  
Schafffräser

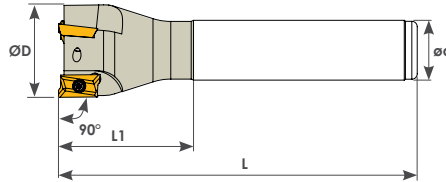

**S10  
APKT 1604**

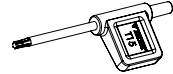

Ölçüler (mm) Dimensions (mm) Abmessungen (mm)		AP-- 1604	
L	S		
16,40	4,76		

Sipariş Kodu Order Code Best.-Nr.	Stok/Stok/Lager	Ürün Kodu Product Code Produkt-Code	Ölçüler (mm) Dimensions (mm) Abmessungen (mm)					Sıkma Civatası Clamp Screw Torx-Schraube	Kullanılan Uç Insert WSP	Anahtar Torx Key Torx-Schlüssel
			ØD	Z	L	ød	L1			
S256	●	D25 Z02 L120 AP--16	25	2	120	25	45	  TC074 M4x10	  AP-- 1604 KRLY	  T15
S258	●	D30 Z03 L120 AP--16	30	3	120	25	45			
S260	●	D32 Z03 L120 AP--16	32	3	120	25	45			
S262	●	D35 Z03 L120 AP--16	35	3	120	25	45			
S264	●	D40 Z04 L120 AP--16	40	4	120	25	45			
S266	●	D25 Z02 L150 AP--16	25	2	150	25	55			
S268	●	D30 Z03 L150 AP--16	30	3	150	25	55			
S270	●	D32 Z03 L150 AP--16	32	3	150	32	55			
S272	●	D35 Z03 L150 AP--16	35	3	150	32	55			
S274	●	D40 Z04 L150 AP--16	40	4	150	32	55			
S276	●	D25 Z02 L200 AP--16	25	2	200	25	65			
S278	●	D30 Z03 L200 AP--16	30	3	200	25	55			
S280	●	D32 Z03 L200 AP--16	32	3	200	32	55			
S282	●	D35 Z03 L200 AP--16	35	3	200	32	55			
S283	●	D40 Z04 L200 AP--16	40	4	200	32	55			
S432	●	D25 Z02 L250 AP--16	25	2	250	25	70			
S434	●	D30 Z03 L250 AP--16	30	3	250	25	60			
S436	●	D32 Z03 L250 AP--16	32	3	250	32	60			
S438	●	D35 Z03 L250 AP--16	35	3	250	32	60			
S440	●	D40 Z04 L250 AP--16	40	4	250	32	60			
S442	●	D25 Z02 L300 AP--16	25	2	300	25	70			
S444	●	D30 Z03 L300 AP--16	30	3	300	25	70			
S446	●	D32 Z03 L300 AP--16	32	3	300	32	70			
S448	●	D35 Z03 L300 AP--16	35	3	300	32	70			
S450	●	D40 Z04 L300 AP--16	40	4	300	32	70			
S453	●	D32 Z03 L350 AP--16	32	3	350	32	70			
S454	●	D35 Z03 L350 AP--16	35	3	350	32	70			
S456	●	D40 Z04 L350 AP--16	40	4	350	32	55			

● Stokta/ In Stock / Lager ○ Sınırlı Stok / Limited Stock / Begrenzte Lagerhaltung  
KRLY ucuna uygundur. / Compatible with KRLY insert. / Kompatible für KRLY WP



**S12**  
**APKT 1003**

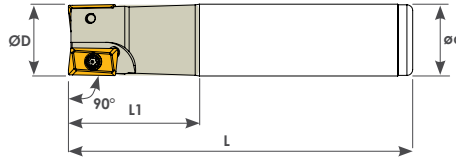

Ölçüler (mm) Dimensions(mm) Abmessungen (mm)		AP-- 1003	
L	S		
10	3,52		

Sipariş Kodu Order Code Best.-Nr.	Stok/Stock/Lager	Ürün Kodu Product Code Produkt-Code	Ölçüler (mm) Dimensions(mm) Abmessungen (mm)					Sıkma Civatası Clamp Screw Torx-Schraube	Kullanılan Uç Insert WSP	Anahtar Torx Key Torx-Schlüssel
			ØD	Z	L	ød	L1			
S136	●	D12 Z01 L100 AP--10	12	1	100	12	27			
S138	●	D14 Z01 L100 AP--10	14	1	100	14	27			
S140	●	D16 Z02 L100 AP--10	16	2	100	16	35			
S142	●	D18 Z02 L100 AP--10	18	2	100	16	30			
S144	●	D20 Z03 L100 AP--10	20	3	100	20	30			
S146	●	D22 Z03 L100 AP--10	22	3	100	20	30			
S148	●	D25 Z03 L100 AP--10	25	3	100	25	35			
S150	●	D30 Z04 L100 AP--10	30	4	100	25	35			
S152	●	D32 Z04 L100 AP--10	32	4	100	25	35			
S154	●	D35 Z04 L100 AP--10	35	4	100	25	35			
S156	●	D40 Z05 L100 AP--10	40	5	100	25	35			
S158	●	D12 Z01 L120 AP--10	12	1	120	12	27			
S160	●	D14 Z01 L120 AP--10	14	1	120	14	27			
S162	●	D16 Z02 L120 AP--10	16	2	120	16	40			
S164	●	D18 Z02 L120 AP--10	18	2	120	16	40			
S166	●	D20 Z03 L120 AP--10	20	3	120	20	40			
S168	●	D22 Z03 L120 AP--10	22	3	120	20	40			
S169	●	D25 Z03 L120 AP--10	25	3	120	25	40			
S170	●	D30 Z04 L120 AP--10	30	4	120	25	40			
S171-1	●	D32 Z04 L120 AP--10	32	4	120	25	40			
S171	●	D35 Z04 L120 AP--10	35	4	120	25	40			
S172	●	D40 Z05 L120 AP--10	40	5	120	25	40			

● Stokta/ In Stock / Lager ○ Sınırlı Stok / Limited Stock / Begrenzte Lagerhaltung  
KRLY ucuna uygundur. / Compatible with KRLY insert. / Kompatible für KRLY WP

**تکنیک تولز**  
ابزار آلات صنعتی، تراشکاری و ماشینکاری  
۶۶۷۱۱۷۳۹ - ۶۶۷۱۱۹۶۷  
تهران، ج. امام خمینی، م. حسن آباد، پاساژ هشت گنبد، شماره ۱۵

**S12**  
**APKT 1003**

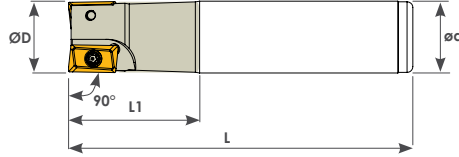

Ölçüler (mm) Dimensions (mm) Abmessungen (mm)		AP-- 1003	
L	S		
10	3,52		

Sipariş Kodu Order Code Best.-Nr.	Stok/Stock/Lager	Ürün Kodu Product Code Produkt-Code	Ölçüler (mm) Dimensions (mm) Abmessungen (mm)					Sıkma Civatası Clamp Screw Torx-Schraube	Kullanılan Uç Insert WSP	Anahtar Torx Key Torx-Schlüssel
			ØD	Z	L	ød	L1			
S173	●	D16 Z02 L150 AP--10	16	2	150	16	50	TC060 M2,5x5,5	AP-- 1003 KRLY	T8
S174	●	D18 Z02 L150 AP--10	18	2	150	16	45			
S176	●	D20 Z03 L150 AP--10	20	3	150	20	60			
S178	●	D22 Z03 L150 AP--10	22	3	150	20	60			
S180	●	D25 Z03 L150 AP--10	25	3	150	25	60			
S180-1	●	D30 Z04 L150 AP--10	30	4	150	25	60			
S181	●	D32 Z04 L150 AP--10	32	4	150	32	45			
S182	●	D16 Z02 L200 AP--10	16	2	200	16	60			
S184	●	D18 Z02 L200 AP--10	18	2	200	16	60			
S186	●	D20 Z03 L200 AP--10	20	3	200	20	70			
S187	●	D22 Z03 L200 AP--10	22	3	200	20	70			
S188	●	D25 Z03 L200 AP--10	25	3	200	25	60			
S188-1	●	D30 Z04 L200 AP--10	30	4	200	25	50			
S189	●	D32 Z04 L200 AP--10	32	4	200	32	60			
S190	●	D16 Z02 L250 AP--10	16	2	250	16	70			
S192	●	D20 Z03 L250 AP--10	20	3	250	20	70			
S194	●	D25 Z03 L250 AP--10	25	3	250	25	70			

● Stokta/ In Stock / Lager ○ Sınırlı Stok / Limited Stock / Begrenzte Lagerhaltung  
KRLY ucuna uygundur. / Compatible with KRLY insert. / Kompatible für KRLY WP

## S13 APMT 0602

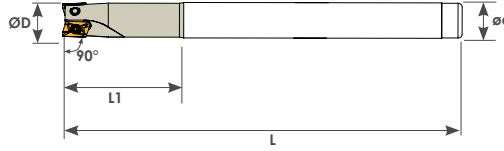

Ölçüler (mm) Dimensions (mm) Abmessungen (mm)	
L	S
6	2,6

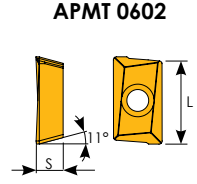

Sipariş Kodu Order Code Best.-Nr.	Stok/Stock/Lager	Ürün Kodu Product Code Produkt-Code	Ölçüler (mm) Dimensions (mm) Abmessungen (mm)					Kullanılan Uç Insert WSP	Sıkma Civatası Clamp Screw Torx-Schraube	Anahtar Torx Key Torx-Schlüssel
			ØD	Z	L	ød	L1			
S009	●	D10 Z02 L120 AP--06	10	2	120	10	30	APMT 06 KRLY	TC058 M2x4,2	T6
S011	●	D12 Z02 L120 AP--06	12	2	120	12	30			

KRLY ucuna uygundur. / Compatible with KRLY insert. / Kompatible für KRLY WP



## S14 XNKT 0604

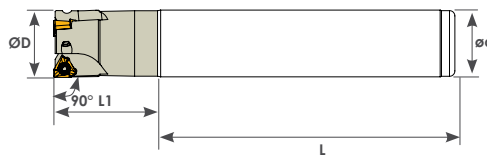

Ölçüler (mm) Dimensions (mm) Abmessungen (mm)		
d	l	s
6,5	5,7	4

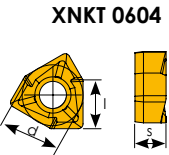

Sipariş Kodu Order Code Best.-Nr.	Stok/Stock/Lager	Ürün Kodu Product Code Produkt-Code	Ölçüler (mm) Dimensions (mm) Abmessungen (mm)					Kullanılan Uç Insert WSP	Sıkma Civatası Clamp Screw Torx-Schraube	Anahtar Torx Key Torx-Schlüssel
			ØD	Z	L	ød	L1			
S834	●	D20 Z02 L150 XN--06	20	2	150	20	40	XNKT 0604 KRLY	TC065 M3x7	T8
S836	●	D21 Z02 L150 XN--06	21	2	150	20	40			
S838	●	D25 Z03 L150 XN--06	25	3	150	25	40			
S840	●	D26 Z03 L150 XN--06	26	3	150	25	40			

● Stokta/ In Stock / Lager ○ Sınırlı Stok / Limited Stock / Begrenzte Lagerhaltung  
KRLY ucuna uygundur. / Compatible with KRLY insert. / Kompatible für KRLY WP

## S15 4NKT 06

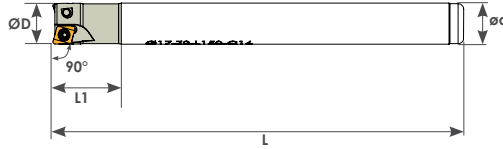

Ölçüler (mm) Dimensions (mm) Abmessungen (mm)		4NKT 06	
L	S		
6,6	4,67		

Sipariş Kodu Order Code Best.-Nr.	Stok/Stock/Lager	Ürün Kodu Product Code Produkt-Code	Ölçüler (mm) Dimensions (mm) Abmessungen (mm)					Kullanılan Uç Insert WSP	Sıkma Cıvatası Clamp Screw Torx-Schraube	Anahtar Torx Key Torx-Schlüssel
			ØD	Z	L	ød	L1			
S472	●	D17 Z02 L150 4N--06	17	2	150	16	20			
S474	●	D21 Z03 L200 4N--06	21	3	200	20	25			
S476	●	D26 Z03 L200 4N--06	26	3	200	25	32			

TGTCucuna uygundur. / Compatible with TGTCinsert. / Kompatible für TGTCWP

## S16 BLMP 0603

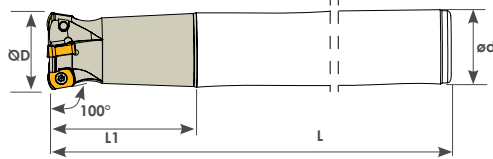

Ölçüler (mm) Dimensions (mm) Abmessungen (mm)			BLMP 0603	
d	l	s		
6,39	9	3,73		

Sipariş Kodu Order Code Best.-Nr.	Stok/Stock/Lager	Ürün Kodu Product Code Produkt-Code	Ölçüler (mm) Dimensions (mm) Abmessungen (mm)					Kullanılan Uç Insert WSP	Sıkma Cıvatası Clamp Screw Torx-Schraube	Anahtar Torx Key Torx-Schlüssel
			ØD	Z	L	ød	L1			
S478	●	D17 Z02 L150 BL--06	17	2	150	16	40			
S480	●	D21 Z03 L200 BL--06	21	3	200	20	40			
S482	●	D26 Z04 L200 BL--06	26	4	200	25	40			



● Stokta/ In Stock / Lager ○ Sınırlı Stok / Limited Stock / Begrenzte Lagerhaltung  
TGTCucuna uygundur. / Compatible with TGTCinsert. / Kompatible für TGTCWP



**S17**  
**ADMX 0702**

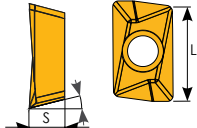
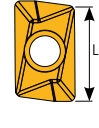

Ölçüler (mm) Dimensions (mm) Abmessungen (mm)		ADMX 0702	
L	S		
7,28	2,48		

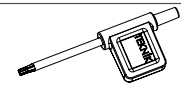
Sipariş Kodu Order Code Best.-Nr.	Stok/Stock/Lager	Ürün Kodu Product Code Produkt-Code	Ölçüler (mm) Dimensions (mm) Abmessungen (mm)					Kullanılan Uç Insert WSP	Sıkma Civatası Clamp Screw Torx-Schraube	Anahtar Torx Key Torx-Schlüssel
			ØD	Z	L	ød	L1			
S751	●	D10 Z02 L080 AD--07	10	2	80	10	16			
S752	●	D10 Z02 L100 AD--07	10	2	100	10	16			
S753	●	D12 Z02 L120 AD--07	12	2	120	12	17			
S754	●	D12 Z03 L090 AD--07	12	3	90	12	16			
S755	●	D12 Z03 L120 AD--07	12	3	120	12	17			
S756	●	D14 Z03 L090 AD--07	14	3	90	12	16			
S757	●	D14 Z03 L140 AD--07	14	3	140	12	18			
S758	●	D16 Z03 L090 AD--07	16	3	90	16	16			
S759	●	D16 Z03 L160 AD--07	16	3	160	16	18			
S760	●	D20 Z04 L125 AD--07	20	4	125	20	17			
S761	●	D20 Z05 L125 AD--07	20	5	125	20	17			

● Stokta / In Stock / Lager ○ Sınırlı Stok / Limited Stock / Begrenzte Lagerhaltung  
PRMT ucuna uygundur. / Compatible with PRMT insert. / Kompatible für PRMT WP



## S18 LNMX 1510

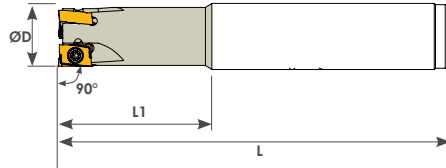

Ölçüler (mm) Dimensions (mm) Abmessungen (mm)			LNMX 1510	
L	S	A		
15	10	10		

Sipariş Kodu Order Code Best.-Nr.	Stok/Stock/Lager	Ürün Kodu Product Code Produkt-Code	Ölçüler (mm) Dimensions (mm) Abmessungen (mm)					Kullanılan Uç Insert WSP	Sıkma Civatası Clamp Screw Torx-Schraube	Anahtar Torx Key Torx-Schlüssel
			ØD	Z	L	ød	L1			
S361	●	D32 Z02 L150 LN--15	32	2	150	32	50			
S362	●	D40 Z03 L150 LN--15	40	3	150	32	50			

KRLY ucuna uygundur. / Compatible with KRLY insert. / Kompatible für KRLY WP



## S19 LNMX 1006

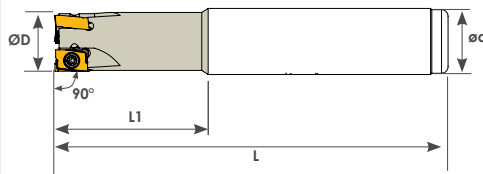

Ölçüler (mm) Dimensions (mm) Abmessungen (mm)			LNMX 1006	
L	S	A		
10	6,6 6,35			

Sipariş Kodu Order Code Best.-Nr.	Stok/Stock/Lager	Ürün Kodu Product Code Produkt-Code	Ölçüler (mm) Dimensions (mm) Abmessungen (mm)					Kullanılan Uç Insert WSP	Sıkma Civatası Clamp Screw Torx-Schraube	Anahtar Torx Key Torx-Schlüssel
			ØD	Z	L	ød	L1			
LN099	●	D20 Z02 L120 LN--10	20	2	120	20	45			
LN100	●	D20 Z03 L120 LN--10	20	3	120	20	45			
LN102	●	D25 Z03 L120 LN--10	25	3	120	25	45			
LN104	●	D26 Z03 L120 LN--10	26	3	120	25	45			

● Stokta / In Stock / Lager ○ Sınırlı Stok / Limited Stock / Begrenzte Lagerhaltung  
KRLY ucuna uygundur. / Compatible with KRLY insert. / Kompatible für KRLY WP

## S20 WNMX 0603

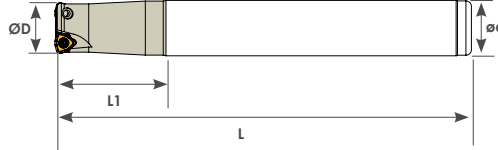

Ölçüler (mm) Dimensions(mm) Abmessungen (mm)			WNMX 0603	
D	I	S		
6,35	4,28	3,18		

Sipariş Kodu Order Code Best.-Nr.	Stok/Stock/Lager	Ürün Kodu Product Code Produkt-Code	Ölçüler (mm) Dimensions(mm) Abmessungen (mm)					Kullanılan Uç Insert WSP	Sıkma Civatası Clamp Screw Torx-Schraube	Anahtar Torx Key Torx-Schlüssel
			ØD	Z	L	ød	L1			
S898	●	D16 Z02 L150 WN--06	16	2	150	16	40			
S899	●	D20 Z02 L150 WN--06	20	2	150	20	40			

KRLY ucuna uygundur. / Compatible with KRLY insert. / Kompatible für KRLY WP

## S21 WNMX 09T3

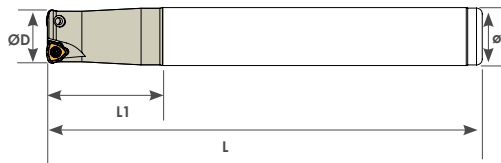

Ölçüler (mm) Dimensions(mm) Abmessungen (mm)			WNMX 09T3	
D	I	S		
9,52	6,8	3,97		

Sipariş Kodu Order Code Best.-Nr.	Stok/Stock/Lager	Ürün Kodu Product Code Produkt-Code	Ölçüler (mm) Dimensions(mm) Abmessungen (mm)					Kullanılan Uç Insert WSP	Sıkma Civatası Clamp Screw Torx-Schraube	Anahtar Torx Key Torx-Schlüssel
			ØD	Z	L	ød	L1			
S802	●	D25 Z02 L150 WN--09	25	2	150	25	60			
S804	●	D30 Z03 L150 WN--09	30	3	150	25	60			

● Stokta/ In Stock / Lager ○ Sınırlı Stok / Limited Stock / Begrenzte Lagerhaltung  
KRLY ucuna uygundur. / Compatible with KRLY insert. / Kompatible für KRLY WP

## S22 ADMT 1204

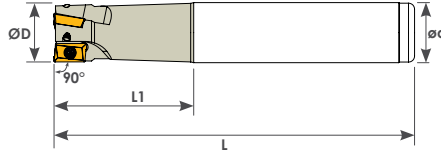

Ölçüler (mm)  
Dimensions (mm)  
Abmessungen (mm)

L	S
13,6	4,76

ADMT 1204

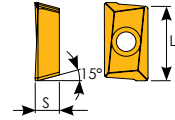

Sipariş Kodu Order Code Best.-Nr.	Stok/Stock/Lager	Ürün Kodu Product Code Produkt-Code	Ölçüler (mm) Dimensions (mm) Abmessungen (mm)					Kullanılan Uç Insert WSP	Sıkma Cıvatası Clamp Screw Torx-Schraube	Anahtar Torx Key Torx-Schlüssel
			ØD	Z	L	ød	L1			
S498	●	D20 Z02 L120 AD--12	20	2	120	20	40	AD-- 1204 WLTR	TC065 M3x7	T8
S500	●	D20 Z02 L150 AD--12	20	2	150	20	55			
S501	●	D20 Z02 L200 AD--12	20	2	200	20	70			
S501-1	●	D25 Z03 L120 AD--12	25	3	120	25	40			
S502	●	D25 Z03 L150 AD--12	25	3	150	25	60			
S503	●	D30 Z04 L150 AD--12	30	4	150	25	60			
S504	●	D32 Z04 L150 AD--12	32	4	150	32	50			
S506	●	D40 Z05 L150 AD--12	40	5	150	32	55			

WLTR ucuna uygundur. / Compatible with WLTR insert. / Kompatibel für WLTR WP



## S23 ADMT 1606

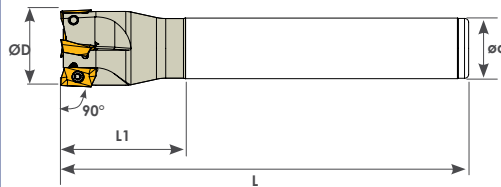

Ölçüler (mm)  
Dimensions (mm)  
Abmessungen (mm)

L	S
17,5	6,15

ADMT 1606

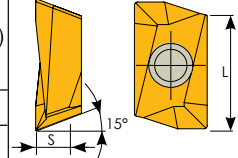

Sipariş Kodu Order Code Best.-Nr.	Stok/Stock/Lager	Ürün Kodu Product Code Produkt-Code	Ölçüler (mm) Dimensions (mm) Abmessungen (mm)					Kullanılan Uç Insert WSP	Sıkma Cıvatası Clamp Screw Torx-Schraube	Anahtar Torx Key Torx-Schlüssel
			ØD	Z	L	ød	L1			
S460	●	D25 Z02 L150 AD--16	25	2	150	25	60	AD-- 1606 WLTR	TC079 M4x11	T15
S461	●	D25 Z02 L200 AD--16	25	2	200	25	60			
S463	●	D26 Z02 L150 AD--16	26	2	150	25	60			
S464	●	D26 Z02 L200 AD--16	26	2	200	25	60			
S466	●	D32 Z03 L150 AD--16	32	3	150	32	60			
S467	●	D32 Z03 L200 AD--16	32	3	200	32	60			
S469	●	D40 Z04 L150 AD--16	40	4	150	32	60			
S470	●	D40 Z04 L200 AD--16	40	4	200	32	60			

● Stokta / In Stock / Lager ○ Sınırlı Stok / Limited Stock / Begrenzte Lagerhaltung  
WLTR ucuna uygundur. / Compatible with WLTR insert. / Kompatibel für WLTR WP

## S24 APKT 0903

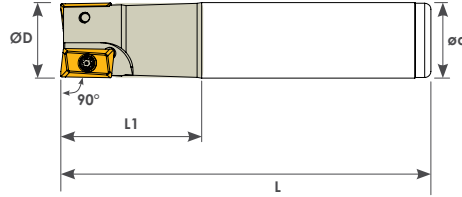

Ölçüler (mm) Dimensions (mm) Abmessungen (mm)		APKT 0903	
L	S		
9,52	3,18		

Sipariş Kodu Order Code Best.-Nr.	Stok/Stock/Lager	Ürün Kodu Product Code Produkt-Code	Ölçüler (mm) Dimensions (mm) Abmessungen (mm)					Sıkma Cıvatası Clamp Screw Torx-Schraube	Kullanılan Uç Insert WSP	Anahtar Torx Key Torx-Schlüssel
			ØD	Z	L	ød	L1			
S204	●	D16 Z02 L120 AP--09	16	2	120	16	40	TC060 M2,5x5,5	APKT 0903 WLTR	T8
S206	●	D20 Z03 L120 AP--09	20	3	120	20	45	TC063 M2,5x7		
S208	●	D25 Z03 L120 AP--09	25	3	120	25	45	TC060 M2,5x5,5		
S210	●	D16 Z02 L150 AP--09	16	2	150	16	45	TC063 M2,5x7		
S212	●	D20 Z03 L150 AP--09	20	3	150	20	45	TC060 M2,5x5,5		
S214	●	D25 Z03 L150 AP--09	25	3	150	25	45	TC063 M2,5x7		
S216	●	D16 Z02 L200 AP--09	16	2	200	16	60	TC060 M2,5x5,5		
S218	●	D20 Z03 L200 AP--09	20	3	200	20	60	TC063 M2,5x7		
S220	●	D25 Z03 L200 AP--09	25	3	200	25	60	TC060 M2,5x5,5		

WLTR ucuna uygundur. / Compatible with WLTR insert. / Kompatible für WLTR WP

## S25 XOMX 0602-0903-1204

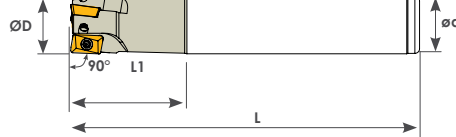
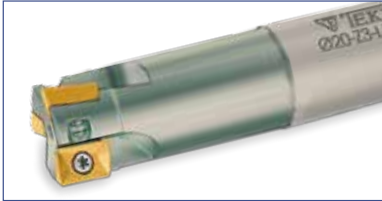

Ölçüler (mm) Dimensions (mm) Abmessungen (mm)		XOMX 1204	
L	S		
12	5,06		

Sipariş Kodu Order Code Best.-Nr.	Stok/Stock/Lager	Ürün Kodu Product Code Produkt-Code	Ölçüler (mm) Dimensions (mm) Abmessungen (mm)					Sıkma Cıvatası Clamp Screw Torx-Schraube	Kullanılan Uç Insert WSP	Anahtar Torx Key Torx-Schlüssel
			ØD	Z	L	ød	L1			
S615	●	D10 Z02 L120 XO--06	10	2	120	10	40	TC051 M1,8x4	XOMX 0602 SCO	T6
S616	●	D12 Z02 L120 XO--06	12	2	120	12	40	TC069 M3,5x8,5	XOMX 0903 SCO	T8
S627	●	D16 Z02 L120 XO--09	16	2	120	16	40			
S626	●	D20 Z03 L120 XO--09	20	3	120	20	40			
S629	●	D16 Z02 L150 XO--09	16	2	150	16	40			
S628	●	D20 Z03 L150 XO--09	20	3	150	20	50			
S638	●	D20 Z02 L120 XO--12	20	2	120	20	45			
S640	●	D20 Z02 L150 XO--12	20	2	150	20	55			
S641	●	D20 Z02 L200 XO--12	20	2	200	20	60			
S642	●	D25 Z03 L120 XO--12	25	3	120	25	45			
S643	●	D25 Z03 L150 XO--12	25	3	150	25	55			
S644	●	D25 Z03 L200 XO--12	25	3	200	25	60			
S645	●	D25 Z03 L250 XO--12	25	3	250	25	60			
S647	●	D32 Z04 L120 XO--12	32	4	120	32	45			
S648	●	D32 Z04 L150 XO--12	32	4	150	32	55			
S650	●	D40 Z04 L150 XO--12	40	4	150	32	55			

SCO ucuna uygundur. / Compatible with SCO insert. / Kompatible für SCO WP

**S26**  
**APKT 11T3 R390**



Ölçüler (mm) Dimensions (mm) Abmessungen (mm)	
L	S
11	3,5

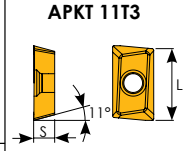

Sipariş Kodu Order Code Best.-Nr.	Stok/Stock/Lager	Ürün Kodu Product Code Produkt-Code	Ölçüler (mm) Dimensions (mm) Abmessungen (mm)					Sıkma Cıvatası Clamp Screw Torx-Schraube	Kullanılan Uç Insert WSP	Anahtar Torx Key Torx-Schlüssel
			ØD	Z	L	ød	L1			
S591	●	D16 Z02 L120 AP--11	16	2	120	16	50	TC060 M2,5x5,5	APKT 11T3 R390 SNDVK	T8
S592	●	D20 Z03 L120 AP--11	20	3	120	20	50	TC063 M2,5x7		
S592-1	●	D25 Z03 L120 AP--11	25	3	120	25	50	TC063 M2,5x7		
S593	●	D16 Z02 L150 AP--11	16	2	150	16	60	TC060 M2,5x5,5		
S593-1	●	D17 Z02 L150 AP--11	17	2	150	16	60	TC063 M2,5x7		
S594	●	D20 Z03 L150 AP--11	20	3	150	20	60			
S594-1	●	D21 Z03 L150 AP--11	21	3	150	20	60			
S595	●	D25 Z03 L150 AP--11	25	3	150	25	60			
S595-1	●	D26 Z04 L150 AP--11	26	4	150	25	60			
S596	●	D20 Z03 L200 AP--11	20	3	200	20	60			
S597	●	D25 Z03 L200 AP--11	25	3	200	25	60			
S598	●	D25 Z03 L250 AP--11	25	3	250	25	60			



SNDVK ucuna uygundur. / Compatible with SNDVK insert. / Kompatible für SNDVK WP

**S27**  
**APKT 1704 R390**

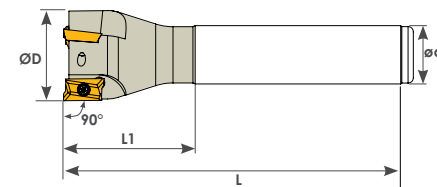

Ölçüler (mm) Dimensions (mm) Abmessungen (mm)	
L	S
17	4,76

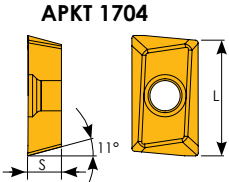

Sipariş Kodu Order Code Best.-Nr.	Stok/Stock/Lager	Ürün Kodu Product Code Produkt-Code	Ölçüler (mm) Dimensions (mm) Abmessungen (mm)					Kullanılan Uç Insert WSP	Sıkma Cıvatası Clamp Screw Torx-Schraube	Anahtar Torx Key Torx-Schlüssel
			ØD	Z	L	ød	L1			
S510	●	D25 Z02 L120 AP--17	25	2	120	25	45	APKT 1704 R390 SNDVK	TC067 M3,5x8,5	T15
S512	●	D30 Z03 L120 AP--17	30	3	120	25	45			
S514	●	D32 Z03 L120 AP--17	32	3	120	25	45			
S518	●	D40 Z04 L120 AP--17	40	4	120	32	45			
S520	●	D25 Z02 L150 AP--17	25	2	150	25	55			
S522	●	D30 Z03 L150 AP--17	30	3	150	25	55			
S524	●	D32 Z03 L150 AP--17	32	3	150	32	55			
S528	●	D40 Z04 L150 AP--17	40	4	150	32	55			
S530	●	D25 Z02 L200 AP--17	25	2	200	25	60			
S532	●	D30 Z03 L200 AP--17	30	3	200	25	55			
S534	●	D32 Z03 L200 AP--17	32	3	200	32	55			
S538	●	D40 Z04 L200 AP--17	40	4	200	32	55			
S548	●	D25 Z02 L300 AP--17	25	2	300	25	80			
S550	●	D32 Z03 L300 AP--17	32	3	300	32	80			

● Stokta / In Stock / Lager ○ Sınırlı Stok / Limited Stock / Begrenzte Lagerhaltung  
SNDVK ucuna uygundur. / Compatible with SNDVK insert. / Kompatible für SNDVK WP

## S28 APKT 1806 R390

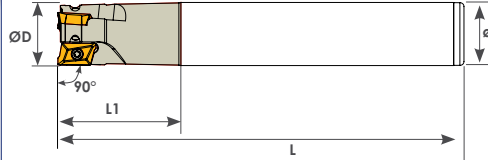

Ölçüler (mm) Dimensions(mm) Abmessungen (mm)		APKT 1806	
L	S		
18	6,3		

Sipariş Kodu Order Code Best.-Nr.	Stok/Stock/Lager	Ürün Kodu Product Code Produkt-Code	Ölçüler (mm) Dimensions(mm) Abmessungen (mm)					Kullanılan Uç Insert WSP	Sıkma Civatası Clamp Screw Torx-Schraube	Anahtar Torx Key Torx-Schlüssel
			ØD	Z	L	ød	L1			
S603	●	D25 Z02 L150 AP--18	25	2	150	25	60	APKT 1806 SNDVK	TC074 M4x10	T15
S600	●	D25 Z02 L200 AP--18	25	2	200	25	60			
S605	●	D32 Z03 L150 AP--18	32	3	150	32	60			
S601	●	D32 Z03 L200 AP--18	32	3	200	32	60			

SNDVK ucuna uygundur. / Compatible with SNDVK insert. / Kompatibel für SNDVK WP

## S29 VCGT 1604

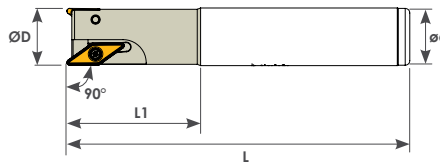

Ölçüler (mm) Dimensions(mm) Abmessungen (mm)		VCGT 1604	
L	S		
16,6	4,76		

Sipariş Kodu Order Code Best.-Nr.	Stok/Stock/Lager	Ürün Kodu Product Code Produkt-Code	Ölçüler (mm) Dimensions(mm) Abmessungen (mm)					Kullanılan Uç Insert WSP	Sıkma Civatası Clamp Screw Torx-Schraube	Anahtar Torx Key Torx-Schlüssel
			ØD	Z	L	ød	L1			
S710	●	D25 Z02 L150 VC--16	25	2	150	25	60	VCGT 1604 ISO	TC074 M4x10	T15
S712	●	D32 Z02 L150 VC--16	32	2	150	32	60			
S714	●	D40 Z03 L150 VC--16	40	3	150	32	60			
S718	●	D25 Z02 L200 VC--16	25	2	200	25	60			
S720	●	D32 Z02 L200 VC--16	32	2	200	32	60			
S724	●	D25 Z02 L250 VC--16	25	2	250	25	60			
S726	●	D32 Z02 L250 VC--16	32	2	250	32	60			

● Stokta/ In Stock / Lager ○ Sınırlı Stok / Limited Stock / Begrenzte Lagerhaltung  
VCGT 16 ISO'dur. / VCGT 16 is ISO. / Kompatibel für ISO WP

## S30 APKT 1705

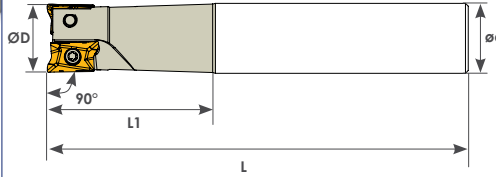

Ölçüler (mm) Dimensions (mm) Abmessungen (mm)		AP -- 1705	
L	S		
17	5,56		

Sipariş Kodu Order Code Best.-Nr.	Stok/Stock/Lager	Ürün Kodu Product Code Produkt-Code	Ölçüler (mm) Dimensions (mm) Abmessungen (mm)					Kullanılan Uç Insert WSP	Sıkma Cıvatası Clamp Screw Torx-Schraube	Anahtar Torx Key Torx-Schlüssel
			ØD	Z	L	ød	L1			
S660	●	D25 Z02 L150 AP--17	25	2	150	25	60	AP-- 1705 TGTC	TC074 M4x10	T15
S662	●	D32 Z03 L150 AP--17	32	3	150	32	60			
S664	●	D40 Z04 L150 AP--17	40	4	150	32	60			

● Stokta/ In Stock / Lager ○ Sınırlı Stok / Limited Stock / Begrenzte Lagerhaltung  
TGTCucuna uygundur. / Compatible with TGTCinsert. / Kompatible für TGTCWP



## S31 AXMT 0602 - 0903

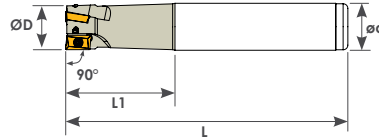
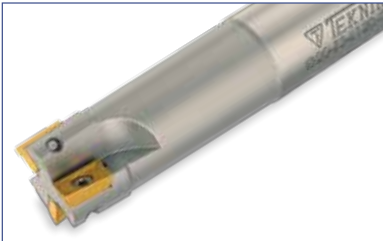

Ölçüler (mm) Dimensions (mm) Abmessungen (mm)		AXMT 0602	AXMT 0903
L	S		
9,5 6	3,6 2,6		

Sipariş Kodu Order Code Best.-Nr.	Stok/Stock/Lager	Ürün Kodu Product Code Produkt-Code	Ölçüler (mm) Dimensions (mm) Abmessungen (mm)					Sıkma Cıvatası Clamp Screw Torx-Schraube	Kullanılan Uç Insert WSP	Anahtar Torx Key Torx-Schlüssel
			ØD	Z	L	ød	L1			
S010	●	D10 Z02 L120 AX--06	10	2	120	10	30	TC051 M1,8x4	AXMT 0602	T6
S012	●	D12 Z02 L120 AX--06	12	2	120	12	30			
S014	●	D16 Z02 L120 AX--09	16	2	120	16	40	TC060 M2,5x5,5	AXMT 0903 TGTC	T8
S015	●	D18 Z02 L120 AX--09	18	2	120	16	40			
S016	●	D20 Z03 L120 AX--09	20	3	120	20	45			
S018	●	D25 Z03 L120 AX--09	25	3	120	25	45			
S020	●	D16 Z02 L150 AX--09	16	2	150	16	50			
S021	●	D18 Z02 L150 AX--09	18	2	150	16	50			
S022	●	D20 Z03 L150 AX--09	20	3	150	20	60			
S024	●	D25 Z03 L150 AX--09	25	3	150	25	60			
S026	●	D16 Z02 L200 AX--09	16	2	200	16	60			
S027	●	D18 Z02 L200 AX--09	18	2	200	16	60			
S028	●	D20 Z03 L200 AX--09	20	3	200	20	70			
S030	●	D25 Z03 L200 AX--09	25	3	200	25	70	TC063 M2,5x7		

● Stokta/ In Stock / Lager ○ Sınırlı Stok / Limited Stock / Begrenzte Lagerhaltung  
TGTCucuna uygundur. / Compatible with TGTCinsert. / Kompatible für TGTCWP



## S32 BDMT 11T3

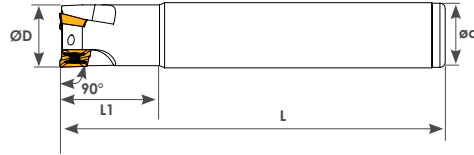

Ölçüler (mm) Dimensions (mm) Abmessungen (mm)		BDMT 11T3	
L	S		
11	3,80		

Sipariş Kodu Order Code Best.-Nr.	Stok/Stok/Lager	Ürün Kodu Product Code Produkt-Code	Ölçüler (mm) Dimensions (mm) Abmessungen (mm)					Kullanılan Uç Insert WSP	Sıkma Cıvatası Clamp Screw Torx-Schraube	Anahtar Torx Key Torx-Schlüssel
			ØD	Z	L	ød	L1			
S565	●	D16 Z02 L150 BD--11	16	2	150	16	45	BDMT 11T3 KYCRA	TC060 M2,5x5,5	T08
S567	●	D20 Z03 L150 BD--11	20	3	150	20	50			
S569	●	D25 Z03 L150 BD--11	25	3	150	25	50			
S570	●	D25 Z03 L200 BD--11	25	3	200	25	60			
S572	●	D32 Z04 L150 BD--11	32	4	150	32	50			
S574	●	D32 Z04 L200 BD--11	32	4	200	32	60			

KYCRA ucuna uygundur. / Compatible with KYCRA insert. / Kompatible für KYCRA WP

## S33 BDMT 1704

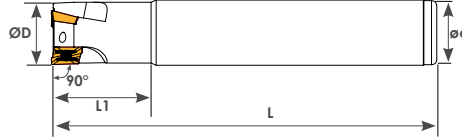
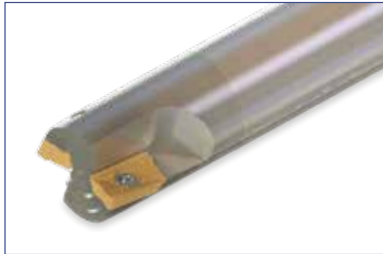

Ölçüler (mm) Dimensions (mm) Abmessungen (mm)		BDMT 1704	
L	S		
17	4,90		

A12 (Uç uygunluk kodu / Relevance of insert code / Relevant von WSP-Code) ▶ S. / P.171

Sipariş Kodu Order Code Best.-Nr.	Stok/Stok/Lager	Ürün Kodu Product Code Produkt-Code	Ölçüler (mm) Dimensions (mm) Abmessungen (mm)					Kullanılan Uç Insert WSP	Sıkma Cıvatası Clamp Screw Torx-Schraube	Anahtar Torx Key Torx-Schlüssel
			ØD	Z	L	ød	L1			
S578	●	D25 Z02 L120 BD--17	25	2	120	25	35	BDMT 1704 KYCRA	TC073 M4x7	T15
S579	●	D25 Z02 L150 BD--17	25	2	150	25	50			
S581	●	D32 Z03 L120 BD--17	32	3	120	32	40			
S582	●	D32 Z03 L150 BD--17	32	3	150	32	60			
S584	●	D40 Z04 L120 BD--17	40	4	120	32	40			
S585	●	D40 Z04 L150 BD--17	40	4	150	32	40			

● Stokta/ In Stock / Lager ○ Sınırlı Stok / Limited Stock / Begrenzte Lagerhaltung

KYCRA ucuna uygundur. / Compatible with KYCRA insert. / Kompatible für KYCRA WP

**S34**  
**ADKT 1505**

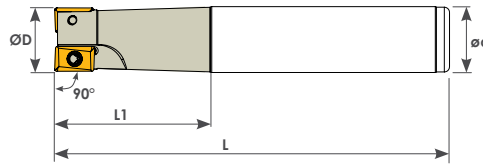

ADKT 1505	
Ölçüler (mm) Dimensions (mm) Abmessungen (mm)	
L	S
15,7	5,63

Sipariş Kodu Order Code Best.-Nr.	Stok/Stock/Lager	Ürün Kodu Product Code Produkt-Code	Ölçüler (mm) Dimensions (mm) Abmessungen (mm)					Sıkma Civatası Clamp Screw Torx-Schraube	Kullanılan Uç Insert WSP	Anahtar Torx Key Torx-Schlüssel
			ØD	Z	L	ød	L1			
S304	●	D25 Z02 L120 AD--15	25	2	120	25	45	TC074 M4x10	ADKT 1505 ISCR	T15
S306	●	D30 Z03 L120 AD--15	30	3	120	25	45			
S307	●	D32 Z03 L120 AD--15	32	3	120	25	45			
S308	●	D35 Z03 L120 AD--15	35	3	120	25	45			
S310	●	D40 Z04 L120 AD--15	40	4	120	25	45			
S312	●	D25 Z02 L150 AD--15	25	2	150	25	55			
S314	●	D30 Z03 L150 AD--15	30	3	150	25	55			
S315	●	D32 Z03 L150 AD--15	32	3	150	32	55			
S316	●	D35 Z03 L150 AD--15	35	3	150	32	55			
S317	●	D40 Z04 L150 AD--15	40	4	150	32	55			
S318	●	D25 Z02 L200 AD--15	25	2	200	25	55			
S319	●	D30 Z03 L200 AD--15	30	3	200	25	55			
S320	●	D32 Z03 L200 AD--15	32	3	200	32	55			
S321	●	D35 Z03 L200 AD--15	35	3	200	32	55			
S322	●	D40 Z04 L200 AD--15	40	4	200	32	55			
S327	●	D40 Z04 L250 AD--15	40	4	250	32	60			

● Stokta / In Stock / Lager ○ Sınırlı Stok / Limited Stock / Begrenzte Lagerhaltung  
ISCR ucuna uygundur. / Compatible with ISCR insert. / Kompatible für ISCR WP



## S35 ANKX 1205

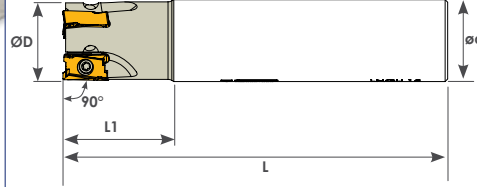

Ölçüler (mm) Dimensions (mm) Abmessungen (mm)			ANKX 1205	
L	S	A		
13,7	9,15	9,3		

Sipariş Kodu Order Code Best.-Nr.	Stok/Stock/Lager	Ürün Kodu Product Code Produkt-Code	Ölçüler (mm) Dimensions (mm) Abmessungen (mm)					Kullanılan Uç Insert WSP	Sıkma Cıvatası Clamp Screw Torx-Schraube	Anahtar Torx Key Torx-Schlüssel
			ØD	Z	L	ød	L1			
S695	●	D32 Z03 L120 AN--12	32	3	120	32	40			
								ANKX1205 ISCR	TC074 M4x11	T15

ISCR ucuna uygundur. / Compatible with ISCR insert. / Kompatible für ISCR WP

## S36 LNGU 15T6

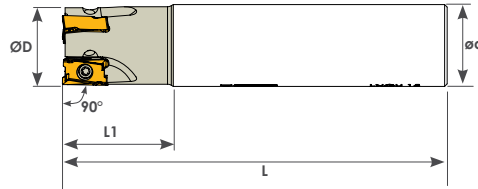

Ölçüler (mm) Dimensions (mm) Abmessungen (mm)			LNGU 15T6	
L	S	A		
17	6,96	10		



Sipariş Kodu Order Code Best.-Nr.	Stok/Stock/Lager	Ürün Kodu Product Code Produkt-Code	Ölçüler (mm) Dimensions (mm) Abmessungen (mm)					Kullanılan Uç Insert WSP	Sıkma Cıvatası Clamp Screw Torx-Schraube	Anahtar Torx Key Torx-Schlüssel
			ØD	Z	L	ød	L1			
S950	●	D25 Z02 L150 LN--15	25	2	150	25	45			
S951	●	D32 Z03 L150 LN--15	32	3	150	32	45	LNGU 15T6 KNNMTL	TC075 M4x11	T15

● Stokta / In Stock / Lager ○ Sınırlı Stok / Limited Stock / Begrenzte Lagerhaltung  
ucuna uygundur. / Compatible with KNNMTL insert. / Kompatible für KNNMTL WP

S37  
SPMG 0502  
SPMG 0602  
SPMG 07T3  
SPMG 0904



Ölçüler (mm) Dimensions (mm) Abmessungen (mm)		SPMG 0502	SPMG 0602
L	S		
5	2,38		
6	2,38		

Ölçüler (mm) Dimensions (mm) Abmessungen (mm)		SPMG 07T3	SPMG 0904
L	S		
7,94	3,97		
9,8	4,3		

A7 (Uç uygunluk kodu / Relevance of insert code / Relevant von WSP-Code)  
► S./P.171

Sipariş Kodu Order Code Best.-Nr.	Stok/Stock/Lager	Ürün Kodu Product Code Produkt-Code	Ölçüler (mm) Dimensions (mm) Abmessungen (mm)					Kullanılan Uç Insert WSP	Sıkma Civatası Clamp Screw Torx-Schraube	Anahtar Torx Key Torx-Schlüssel
			ØD	Z	L	ød	L1			
S810	●	D013 Z02 L120 SP--05	13	2	120	14	40	SPMG 0502 TGTC	TC058 M2x4,2	T6
S812	●	D13.5 Z02 L120 SP--06	13.5	2	120	14	40	SPMG 0602 TGTC	TC059 M2,2x5	T7
S814	●	D014 Z02 L120 SP--06	14	2	120	14	40			
S816	●	D14.5 Z02 L120 SP--06	14.5	2	120	14	40			
S818	●	D015 Z02 L120 SP--06	15	2	120	16	40			
S820	●	D15.5 Z02 L120 SP--06	15.5	2	120	16	40			
S822	●	D016 Z02 L120 SP--06	16	2	120	16	40			
S824	●	D020 Z02 L150 SP--07	20	2	150	20	50	SPMG 07T3 TGTC	TC063 M2,5x7	T8
S826	●	D20.5 Z02 L120 SP--07	20.5	2	120	20	50	SPMG 0904 TGTC	TC067 M3,5x9	T15
S828	●	D025 Z02 L150 SP--09	25	2	150	25	50			
S830	●	D032 Z03 L150 SP--09	32	3	150	32	50			

● Stokta/ In Stock / Lager ○ Sınırlı Stok / Limited Stock / Begrenzte Lagerhaltung  
TGTCucuna uygundur. / Compatible with TGTCinsert. / Kompatible für TGTCWP

S38  
RT 0702  
RT 1003  
RT 1606

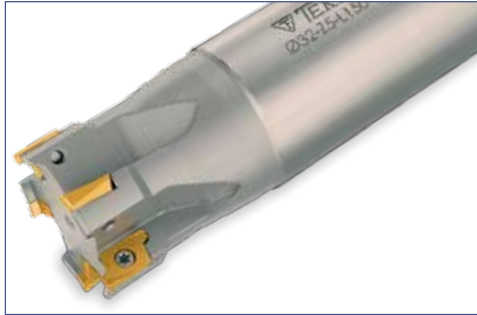
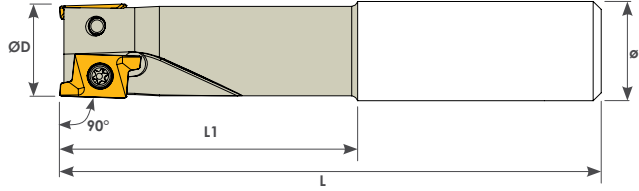

Ölçüler (mm) Dimensions(mm) Abmessungen (mm)		RT 0702	
L	S		
7	2,38		

Ölçüler (mm) Dimensions(mm) Abmessungen (mm)		RT 1003		RT 1606	
L	S				
10 18	3,4 6,35				

Sipariş Kodu Order Code Best.-Nr.	Stok/Stock/Lager	Ürün Kodu Product Code Produkt-Code	Ölçüler (mm) Dimensions(mm) Abmessungen (mm)					Kullanılan Uç Insert WSP	Sıkma Civatası Clamp Screw Torx-Schraube	Anahtar Torx Key Torx-Schlüssel
			ØD	Z	L	ød	L1			
G100	●	D10 Z02 L120 RT--07	10	2	120	10	30	RT 0702 SFTY	TC058 M2x4,2	T6
G102	●	D12 Z02 L120 RT--07	12	2	120	12	30			
G110	●	D16 Z02 L120 RT--10	16	2	120	16	30			
G114	●	D20 Z03 L120 RT--10	20	3	120	20	40			
G118	●	D25 Z04 L120 RT--10	25	4	120	25	40			
G130	●	D16 Z02 L150 RT--10	16	2	150	16	40	RT 1003 SFTY	TC063 M2,5x7	T8
G134	●	D20 Z03 L150 RT--10	20	3	150	20	60			
G150	●	D16 Z02 L200 RT--10	16	2	200	16	80			
G152	●	D20 Z03 L200 RT--10	20	3	200	20	80			
G156	●	D25 Z04 L200 RT--10	25	4	200	25	80	RT 1606 SFTY	TC075 M4x11	T15
G202	●	D32 Z03 L200 RT--16	32	3	200	32	60			
G206	●	D32 Z03 L250 RT--16	32	3	250	32	60			
G208	●	D32 Z03 L270 RT--16	32	3	270	32	60			

● Stokta/ In Stock / Lager ○ Sınırlı Stok / Limited Stock / Begrenzte Lagerhaltung  
SFTY ucuna uygundur. / Compatible with SFTY insert. / Kompatible für SFTY WP



TPKN 1103  
TPKN 1603  
TPKN 2204

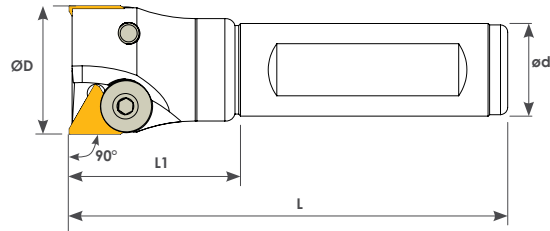
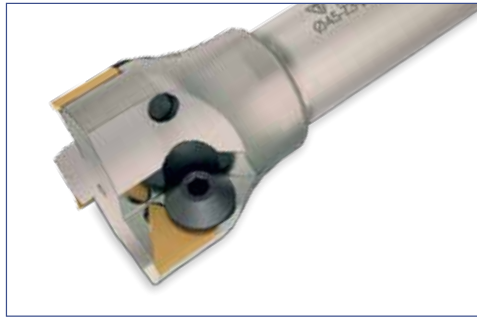

Ölçüler (mm) Dimensions (mm) Abmessungen (mm)		TPKN 1103	TPKN 2204
L	S		
11	3,18		
16,5	3,18		
22	4,76		

**تکنیک تولز**

ابزار آلات صنعتی، تراشکاری و قالبسازی

۶۶۷۱۱۷۲۹ - ۶۶۷۱۱۹۶۷

تهران، خ امام خمینی، م حسن آباد، پاساژ هشت گنبد، شماره ۱۵

Sipariş Kodu Order Code Best.-Nr.	Stok/Stock/Lager	Ürün Kodu Product Code Produkt-Code	Ölçüler (mm) Dimensions (mm) Abmessungen (mm)					Kullanılan Uç Insert WSP	Baskı Cıvatası Locking Screw Verriegelungsschraub	Anahtar Allen Key Inbuss-Schlüssel
			ØD	Z	L	ød	L1			
S116	●	D22 Z02 L120 TP--11	22	2	120	20	45	TPKN 1103 ISO	TC050 M6x14	3 Allen
S118	●	D25 Z02 L120 TP--11	25	2	120	25	45			
S120	●	D28 Z02 L120 TP--11	28	2	120	25	45			
S122	●	D30 Z03 L120 TP--11	30	3	120	25	45			
S124	●	D32 Z03 L120 TP--11	32	3	120	25	45			
S126	●	D35 Z03 L120 TP--11	35	3	120	25	45			
S128	●	D35 Z02 L120 TP--16	35	2	120	25	45	TPKN 1603 ISO	TC052 M6x17	4 Allen
S130	●	D40 Z03 L120 TP--16	40	3	120	25	45			
S132	●	D45 Z03 L120 TP--16	45	3	120	25	45			
S134	●	D50 Z03 L120 TP--22	50	3	120	32	55	TPKN 2204 ISO	TC054 M8x24	5 Allen

● Stokta/ In Stock / Lager ○ Sınırlı Stok / Limited Stock / Begrenzte Lagerhaltung  
TPKN 1103-1603-2204 ISO'dur. / TPKN 1103-1603-2204 is ISO. / Kompatible für ISO WP

## S40 RDMW 0501

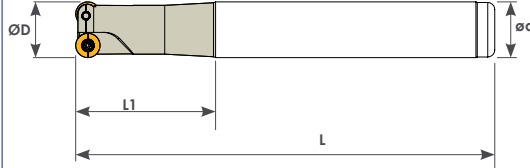

Ölçüler (mm) Dimensions (mm) Abmessungen (mm)		RDMW 0501	
d	S		
5	1,5		

Sipariş Kodu Order Code Best.-Nr.	Stok/Stock/Lager	Ürün Kodu Product Code Produkt-Code	Ölçüler (mm) Dimensions (mm) Abmessungen (mm)					Kullanılan Uç Insert WSP	Sıkma Civatası Clamp Screw Torx-Schraube	Anahtar Torx Key Torx-Schlüssel
			ØD	Z	L	ød	L1			
R080	●	D08 Z01 L080 RD--05	8	1	80	10	27	 RD-- 0501 TGTC	 TC058 M2x4,2	 T6
R082	●	D10 Z02 L080 RD--05	10	2	80	12	27			
R084	●	D10 Z02 L120 RD--05	10	2	120	12	45			
R086	●	D12 Z02 L100 RD--05	12	2	100	12	45			
R088	●	D12 Z02 L120 RD--05	12	2	120	12	45			

TGTCucuna uygundur. / Compatible with TGTCinsert. / Kompatible für TGTCWP



## S41 RDMW 0702



Ölçüler (mm) Dimensions (mm) Abmessungen (mm)		RDMW 0702	
d	S		
7	2,38		

Sipariş Kodu Order Code Best.-Nr.	Stok/Stock/Lager	Ürün Kodu Product Code Produkt-Code	Ölçüler (mm) Dimensions (mm) Abmessungen (mm)					Kullanılan Uç Insert WSP	Sıkma Civatası Clamp Screw Torx-Schraube	Anahtar Torx Key Torx-Schlüssel
			ØD	Z	L	ød	L1			
R136	●	D15 Z02 L120 RD--07	15	2	120	16	40	 RD-- 0702 TGTC	 TC060 M2,5x5,5	 T8
R138	●	D16 Z02 L120 RD--07	16	2	120	16	40			
R142	●	D20 Z03 L120 RD--07	20	3	120	20	40			
R143	●	D15 Z02 L150 RD--07	15	2	150	16	50			
R144	●	D16 Z02 L150 RD--07	16	2	150	16	60			
R148	●	D20 Z03 L150 RD--07	20	3	150	20	60			

● Stokta/ In Stock / Lager ○ Sınırlı Stok / Limited Stock / Begrenzte Lagerhaltung  
TGTCucuna uygundur. / Compatible with TGTCinsert. / Kompatible für TGTCWP

## RDMT 1003

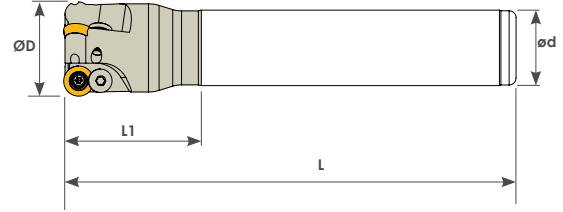

Ölçüler (mm)  
Dimensions (mm)  
Abmessungen (mm)

d	s
10	3,18

RDMT 1003

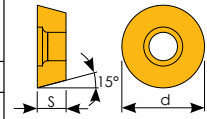

Sipariş Kodu Order Code Best.-Nr.	Stok/Stock/Lager	Ürün Kodu Product Code Produkt-Code	Ölçüler (mm) Dimensions (mm) Abmessungen (mm)					Kullanılan Uç Insert WSP	Sıkma Cıvatası Clamp Screw Torx-Schraube	Baskı Cıvatası Locking Screw Verriegelungs Schraube	Anahtar Torx Key Torx-Schlüssel
			ØD	Z	L	ød	L1				
R190	●	D20 Z02 L120 RD--10	20	2	120	20	54	RD-- 1003 ISO	TC067 M3,5x9	TC040 M3,5	T15
R192	●	D25 Z02 L120 RD--10	25	2	120	25	40				
R193	●	D30 Z03 L120 RD--10	30	3	120	25	40				
R194	●	D32 Z03 L120 RD--10	32	3	120	25	40				
R196	●	D35 Z03 L120 RD--10	35	3	120	25	40				
R198	●	D40 Z04 L120 RD--10	40	4	120	25	40				
R200	●	D20 Z02 L150 RD--10	20	2	150	20	60				
R202	●	D25 Z02 L150 RD--10	25	2	150	25	60				
R203	●	D30 Z03 L150 RD--10	30	3	150	25	60				
R204	●	D32 Z03 L150 RD--10	32	3	150	32	45				
R206	●	D35 Z03 L150 RD--10	35	3	150	32	60				
R208	●	D40 Z04 L150 RD--10	40	4	150	32	60				
R210	●	D20 Z02 L200 RD--10	20	2	200	20	70				
R212	●	D25 Z02 L200 RD--10	25	2	200	25	70				
R213	●	D30 Z03 L200 RD--10	30	3	200	25	70				
R214	●	D32 Z03 L200 RD--10	32	3	200	32	70				
R216	●	D35 Z03 L200 RD--10	35	3	200	32	70				
R218	●	D40 Z04 L200 RD--10	40	4	200	32	70				

● Stokta / In Stock / Lager ○ Sınırlı Stok / Limited Stock / Begrenzte Lagerhaltung

RDMT 1003 ISO'dur. / RDMT 1003 is ISO. / Kompatible für ISO WP



## RDMT 12T3

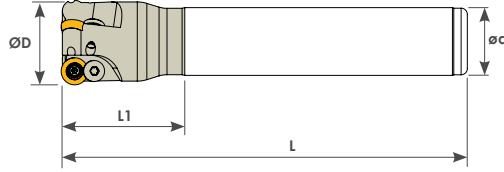

RDMT 12T3	
Ölçüler (mm) Dimensions (mm) Abmessungen (mm)	
d	S
12	3,97

Sipariş Kodu Order Code Best.-Nr.	Stok/Stock/Lager	Ürün Kodu Product Code Produkt-Code	Ölçüler (mm) Dimensions (mm) Abmessungen (mm)					Kullanılan Uç Insert WSP	Sıkma Civatası Clamp Screw Torx-Schraube	Baskı Civatası Locking Screw Verriegelungs Schraube	Anahtar Torx Key Torx-Schlüssel
			ØD	Z	L	ød	L1				
R228	●	D25 Z02 L120 RD--12	25	2	120	25	40	RD-- 12T3 ISO	TC067 M3,5x9	TC040 M3,5	T15
R229	●	D30 Z02 L120 RD--12	30	2	120	25	40				
R230	●	D32 Z03 L120 RD--12	32	3	120	25	40				
R232	●	D35 Z03 L120 RD--12	35	3	120	25	40				
R234	●	D40 Z03 L120 RD--12	40	3	120	25	40				
R236	●	D25 Z02 L150 RD--12	25	2	150	25	60				
R237	●	D30 Z02 L150 RD--12	30	2	150	25	60				
R238	●	D32 Z03 L150 RD--12	32	3	150	32	60				
R240	●	D35 Z03 L150 RD--12	35	3	150	32	60				
R242	●	D40 Z03 L150 RD--12	40	3	150	32	60				
R244	●	D25 Z02 L200 RD--12	25	2	200	25	70				
R245	●	D30 Z02 L200 RD--12	30	2	200	25	70				
R246	●	D32 Z03 L200 RD--12	32	3	200	32	70				
R248	●	D35 Z03 L200 RD--12	35	3	200	32	70				
R250	●	D40 Z03 L200 RD--12	40	3	200	32	70				
R255	●	D30 Z02 L300 RD--12	30	2	300	25	70				
R256	●	D32 Z03 L300 RD--12	32	3	300	32	70				
R258	●	D35 Z03 L300 RD--12	35	3	300	32	70				

● Stokta / In Stock / Lager ○ Sınırlı Stok / Limited Stock / Begrenzte Lagerhaltung  
RDMT 12T3 ISO'dur. / RDMT 12T3 is ISO. / Kompatible für ISO WP

**S42**  
**F75° APKT 1003**

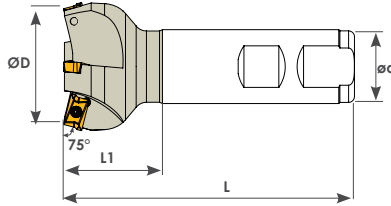

Ölçüler (mm) Dimensions (mm) Abmessungen (mm)		AP-- 1003	
L	S		
10	3,52		

Sipariş Kodu Order Code Best.-Nr.	Stok/Stock/Lager	Ürün Kodu Product Code Produkt-Code	Ölçüler (mm) Dimensions (mm) Abmessungen (mm)					Kullanılan Uç Insert WSP	Sıkma Cıvatası Clamp Screw Torx-Schraube	Anahtar Torx Key Torx-Schlüssel
			ØD	Z	L	ød	L1			
S344	●	D32 Z03 L100 AP--10	32	3	100	25	35	AP-- 1003 -KRLY-	TC060 M2,5x5,5	T8
S346	●	D40 Z04 L100 AP--10	40	4	100	25	35			
S348	●	D45 Z04 L100 AP--10	45	4	100	25	35			
S350	●	D50 Z05 L100 AP--10	50	5	100	25	35			

● Stokta / In Stock / Lager ○ Sınırlı Stok / Limited Stock / Begrenzte Lagerhaltung  
KRLY ucuna uygundur. / Compatible with KRLY insert. / Kompatibel für KRLY WP



S44

## KÜRE UÇLU FREZE

Indexable Ball Nose End Mill

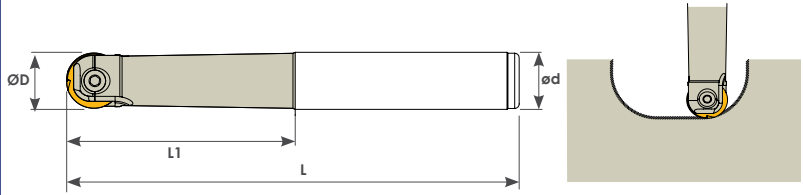

Sipariş Kodu Order Code Best.-Nr.	Stok/Stock/Lager	Ürün Kodu Product Code Produkt-Code	Ölçüler (mm) Dimensions(mm) Abmessungen (mm)				Kullanılan Uç Insert WSP	Sıkma Cıvatası Clamp Screw Torx-Schraube	Anahtar Torx Key Torx-Schlüssel
			ØD	L	ød	L1			
S370	●	D08 d10 L130 P32-08	8	130	10	36	P3201 D08WLTR	TC170 M3	T8
S372	●	D10 d12 L130 P32-10	10	130	12	47	P3201 D10WLTR	TC172 M4	T15
S374	●	D12 d12 L150 P32-12	12	150	12	47	P3201 D12WLTR	TC174 M5	T20
S376	●	D16 d16 L175 P32-16	16	175	16	47	P3201 D16WLTR	TC176 M5	T20
S378	●	D20 d20 L200 P32-20	20	200	20	56	P3201 D20WLTR	TC178 M5	T20
S380	●	D25 d25 L200 P32-25	25	200	25	66	P3201 D25WLTR	TC181 M6	3 Allen
S381	●	D30 d32 L200 P32-30	30	200	32	66	P3201 D30WLTR	TC184 M8	4 Allen
S382	●	D32 d32 L200 P32-32	32	200	32	66	P3201 D32WLTR	TC184 M8	4 Allen

WLTR ucuna uygundur. / Compatible with WLTR insert. / Kompatible für WLTR WP

S45

## KÜRE UÇLU FREZE

Indexable Ball Nose End Mill

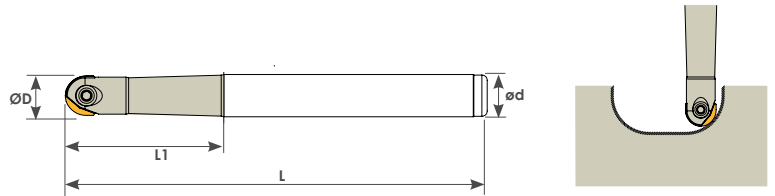
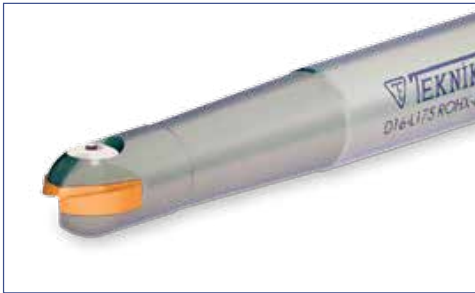

تهران، خ امام خمینی، م حسن آباد، پاساژ هشت گنبد، شماره 15  
۱۶۷۱۱۷۲۹ - ۱۶۷۱۱۹۶۷

Sipariş Kodu Order Code Best.-Nr.	Stok/Stock/Lager	Ürün Kodu Product Code Produkt-Code	Ölçüler (mm) Dimensions(mm) Abmessungen (mm)				Kullanılan Uç Insert WSP	Sıkma Cıvatası Clamp Screw Torx-Schraube	Anahtar Torx Key Torx-Schlüssel
			ØD	L	ød	L1			
S364	●	D12 d14 L150 ROHX	12	150	14	35	ROHX D12ZCC	TC172 M4	T15
S366	●	D16 d16 L175 ROHX	16	175	16	60	ROHX D16ZCC	TC176 M5	T20
S368	●	D20 d20 L200 ROHX	20	200	20	53	ROHX D20ZCC	TC178 M5	T20

● Stokta / In Stock / Lager ○ Sınırlı Stok / Limited Stock / Begrenzte Lagerhaltung  
ZCC ucuna uygundur. / Compatible with ZCC insert. / Kompatible für ZCC WP



تکنیک تولز

ابزار آلات صنعتی، تراشکاری و ماشینکاری

۶۶۷۱۱۶۶۷ - ۶۶۷۱۱۷۲۹

تهران، خ امام خمینی، م حسن آباد، پاساژ هشت گنبد، شماره ۱۵

**Vidalı Takımları**  
Screw Head  
Einschraubfräser

## Vidalı Takım Tutucu

Screw Head Holder

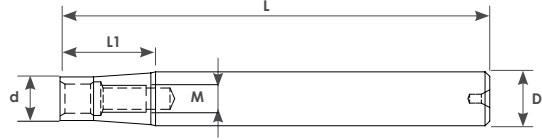

Sipariş Kodu Order Code Best.-Nr.	Stok/Stock/Lager	Ürün Kodu Product Code Produkt-Code	Ölçüler (mm) Dimensions (mm) Abmessungen (mm)				
			D	d	L	L1	M
VT500	●	D15-L150 M8 VİDALI TAKIM TUTUCU	15	12,7	150	30	M8
VT502	●	D16-L100 M8 VİDALI TAKIM TUTUCU	16	12,7	100	30	M8
VT504	●	D16-L150 M8 VİDALI TAKIM TUTUCU	16	12,7	150	30	M8
VT506	●	D19-L150 M10 VİDALI TAKIM TUTUCU	19	17,7	150	30	M10
VT508	●	D20-L100 M10 VİDALI TAKIM TUTUCU	20	17,7	100	30	M10
VT510	●	D20-L150 M10 VİDALI TAKIM TUTUCU	20	17,7	150	40	M10
VT512	●	D24-L150 M12 VİDALI TAKIM TUTUCU	24	20,7	150	40	M12
VT514	●	D25-L150 M12 VİDALI TAKIM TUTUCU	25	20,7	150	40	M12
VT516	●	D25-L200 M12 VİDALI TAKIM TUTUCU	25	20,7	200	40	M12
VT518	●	D25-L250 M12 VİDALI TAKIM TUTUCU	25	20,7	250	40	M12
VT520	●	D32-L170 M16 VİDALI TAKIM TUTUCU	32	28,7	170	40	M16
VT522	●	D32-L220 M16 VİDALI TAKIM TUTUCU	32	28,7	220	40	M16
VT524	●	D32-L300 M16 VİDALI TAKIM TUTUCU	32	28,7	300	40	M16

● Stokta/ In Stock / Lager ○ Sınırlı Stok / Limited Stock / Begrenzte Lagerhaltung



**V1  
APKT 1003**

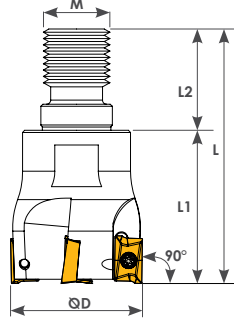

Ölçüler (mm) Dimensions (mm) Abmessungen (mm)		AP-- 1003	
L	S		
10,5	3,52		

Sipariş Kodu Order Code Best.-Nr.	Stok/Stock/Lager	Ürün Kodu Product Code Produkt-Code	Ölçüler (mm) Dimensions (mm) Abmessungen (mm)						Kullanılan Uç Insert WSP	Sıkma Cıvatası Clamp Screw Torx-Schraube	Anahtar Torx Key Torx-Schlüssel
			ØD	Z	M	L	L1	L2			
VT136	●	D16 Z02 M08 AP--10	16	2	M08	41	25	16	AP-- 1003 KRLY	TC060 M2,5x5,5	T8
VT138	●	D20 Z03 M10 AP--10	20	3	M10	55	33	17			
VT140	●	D25 Z03 M12 AP--10	25	3	M12	55	33	22			
VT143	●	D32 Z04 M16 AP--10	32	4	M16	60	36	24			
VT146	●	D35 Z04 M16 AP--10	35	4	M16	60	36	24			
VT148	●	D40 Z05 M16 AP--10	40	5	M16	60	36	24			
VT150	●	D42 Z05 M16 AP--10	42	5	M16	60	36	24			

KRLY ucuna uygundur. / Compatible with KRLY insert. / Kompatible für KRLY WP

**V2  
APKT 1604**

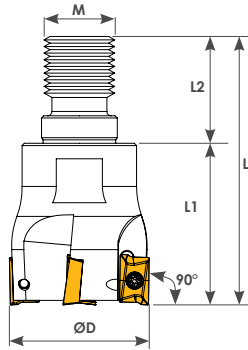

Ölçüler (mm) Dimensions (mm) Abmessungen (mm)		AP-- 1604	
L	S		
16,40	4,76		

Sipariş Kodu Order Code Best.-Nr.	Stok/Stock/Lager	Ürün Kodu Product Code Produkt-Code	Ölçüler (mm) Dimensions (mm) Abmessungen (mm)						Kullanılan Uç Insert WSP	Sıkma Cıvatası Clamp Screw Torx-Schraube	Anahtar Torx Key Torx-Schlüssel
			ØD	Z	M	L	L1	L2			
VT160	●	D25 Z02 M12 AP--16	25	2	M12	55	33	22	AP-- 1604 KRLY	TC074 M4x10	T15
VT163	●	D32 Z03 M16 AP--16	32	3	M16	60	36	24			
VT166	●	D35 Z03 M16 AP--16	35	3	M16	60	36	24			
VT168	●	D40 Z04 M16 AP--16	40	4	M16	60	36	24			
VT170	●	D42 Z04 M16 AP--16	42	4	M16	60	36	24			

● Stokta / In Stock / Lager ○ Sınırlı Stok / Limited Stock / Begrenzte Lagerhaltung  
KRLY ucuna uygundur. / Compatible with KRLY insert. / Kompatible für KRLY WP

## V8 BLMP 0603

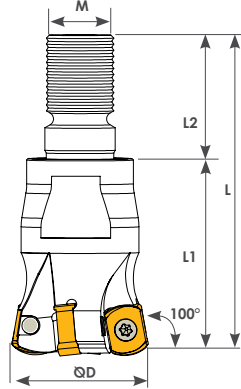

Ölçüler (mm) Dimensions (mm) Abmessungen (mm)			BLMP 0603	
d	l	s		
6,39	9	3,73		

Sipariş Kodu Order Code Best.-Nr.	Stok/Stock/Lager	Ürün Kodu Product Code Produkt-Code	Ölçüler (mm) Dimensions (mm) Abmessungen (mm)						Kullanılan Uç Insert WSP	Sıkma Civatası Clamp Screw Torx-Schraube	Anahtar Torx Key Torx-Schlüssel
			ØD	Z	M	L	L1	L2			
VT190	●	D16 Z02 M08 BL--06	16	2	M08	41	25	16	BLMP 0603 TGTC	TC064 M3x6,5	T8
VT191	●	D20 Z03 M10 BL--06	20	3	M10	48	30	17			
VT192	●	D25 Z04 M12 BL--06	25	4	M12	57	35	22			
VT193	●	D32 Z05 M16 BL--06	32	5	M16	65,3	40	25,3			
VT194	●	D35 Z05 M16 BL--06	35	5	M16	65,3	40	25,3			
VT195	●	D40 Z06 M16 BL--06	40	6	M16	68,3	43	25,3			
VT196	●	D42 Z06 M16 BL--06	42	6	M16	68,3	43	25,3			

TGTCucuna uygundur. / Compatible with TGTCinsert. / Kompatible für TGTCWP

## V10 ADMX 07

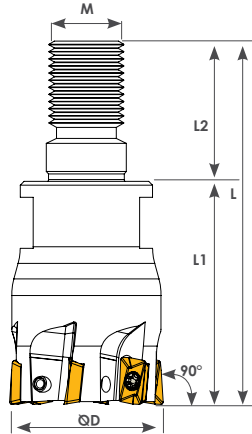

Ölçüler (mm) Dimensions (mm) Abmessungen (mm)		ADMX 07	
L	S		
7,28	2,57		

Sipariş Kodu Order Code Best.-Nr.	Stok/Stock/Lager	Ürün Kodu Product Code Produkt-Code	Ölçüler (mm) Dimensions (mm) Abmessungen (mm)						Kullanılan Uç Insert WSP	Sıkma Civatası Clamp Screw Torx-Schraube	Anahtar Torx Key Torx-Schlüssel
			ØD	Z	M	L	L1	L2			
VT200	●	D16 Z04 M08 AD--07	16	4	M08	55	33	22	ADMX 07 PRMT	TC058 M2x4,2	T6
VT201	●	D20 Z05 M10 AD--07	20	5	M10	60	36	24			
VT202	●	D25 Z06 M12 AD--07	25	6	M12	60	36	24			
VT203	●	D32 Z08 M16 AD--07	32	8	M16	60	36	24			

● Stokta/ In Stock / Lager ○ Sınırlı Stok / Limited Stock / Begrenzte Lagerhaltung  
PRMT ucuna uygundur. / Compatible with PRMT insert. / Kompatible für PRMT WP

**V11  
RPMT 10**

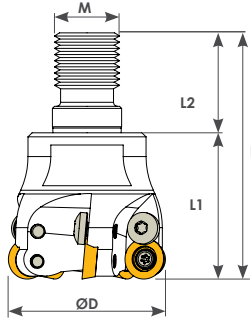

Ölçüler (mm) Dimensions (mm) Abmessungen (mm)		RPMT 10T3	
d	S		
10	3,97		

Sipariş Kodu Order Code Best.-Nr.	Stok/Stock/Lager	Ürün Kodu Product Code Produkt-Code	Ölçüler (mm) Dimensions (mm) Abmessungen (mm)						Kullanılan Uç Insert WSP	Baskı Cıvatası Locking Screw Verriegelungs Schraube	Sıkma Cıvatası Clamp Screw Torx-Schraube	Anahtar Torx Key Torx-Schlüssel
			ØD	Z	M	L	L1	L2				
VT178	●	D20 Z02 M10 RP--10	20	2	M10	55	35	20	RPMT 10 MTSBSH	TC040 M3,5	TC067 M3,5x9	T15
VT180	●	D25 Z03 M12 RP--10	25	3	M12	55	33	22				
VT182	●	D32 Z03 M16 RP--10	32	3	M16	60	36	24				

MTSBSH ucuna uygundur. / Compatible with MTSBSH insert. / Kompatible für MTSBSH WP



**V12  
RPMT 12**

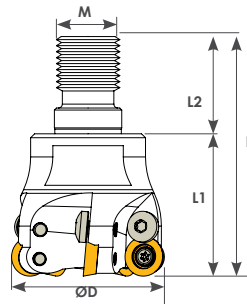

Ölçüler (mm) Dimensions (mm) Abmessungen (mm)		RPMT 1204	
d	S		
12	4,76		

Sipariş Kodu Order Code Best.-Nr.	Stok/Stock/Lager	Ürün Kodu Product Code Produkt-Code	Ölçüler (mm) Dimensions (mm) Abmessungen (mm)						Kullanılan Uç Insert WSP	Baskı Cıvatası Locking Screw Verriegelungs Schraube	Sıkma Cıvatası Clamp Screw Torx-Schraube	Anahtar Torx Key Torx-Schlüssel
			ØD	Z	M	L	L1	L2				
VT172	●	D20 Z02 M08 RP--12	20	2	M10	55	35	20	RPMT 12 MTSBSH	TC040 M3,5	TC067 M3,5x9	T15
VT174	●	D25 Z03 M10 RP--12	25	3	M12	55	33	22				
VT176	●	D32 Z03 M12 RP--12	32	3	M16	60	36	24				

● Stokta/ In Stock / Lager ○ Sınırlı Stok / Limited Stock / Begrenzte Lagerhaltung

MTSBSH ucuna uygundur. / Compatible with MTSBSH insert. / Kompatible für MTSBSH WP



## RDMT 1003

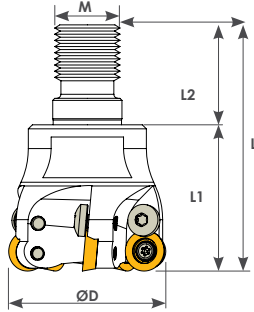

Ölçüler (mm) Dimensions (mm) Abmessungen (mm)		RDMT 1003	
d	S		
10	3,18		

Sipariş Kodu Order Code Best.-Nr.	Stok/Stock/Lager	Ürün Kodu Product Code Produkt-Code	Ölçüler (mm) Dimensions (mm) Abmessungen (mm)						Kullanılan Uç Insert WSP	Baskı Civatası Locking Screw Verriegelungs Schraube	Sıkma Civatası Clamp Screw Torx-Schraube	Anahtar Torx Key Torx-Schlüssel
			ØD	Z	M	L	L1	L2				
VT098	●	D20 Z02 M10 RD--10	20	2	M10	55	35	20				
VT100	●	D25 Z03 M12 RD--10	25	3	M12	55	33	22				
VT103	●	D32 Z03 M16 RD--10	32	3	M16	60	36	24				
VT106	●	D35 Z04 M16 RD--10	35	4	M16	60	36	24				
VT108	●	D40 Z05 M16 RD--10	40	5	M16	60	36	24				
VT110	●	D42 Z05 M16 RD--10	42	5	M16	60	36	24				

RDMT 1003 ISO'dur./ RDMT 1003 is ISO. / Kompatible für ISO WP

## RDMT 12T3

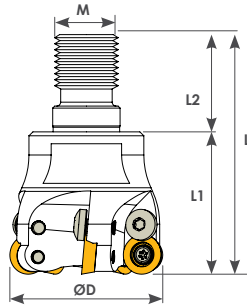

Ölçüler (mm) Dimensions (mm) Abmessungen (mm)		RDMT 12T3	
d	S		
12	3,97		



Sipariş Kodu Order Code Best.-Nr.	Stok/Stock/Lager	Ürün Kodu Product Code Produkt-Code	Ölçüler (mm) Dimensions (mm) Abmessungen (mm)						Kullanılan Uç Insert WSP	Baskı Civatası Locking Screw Verriegelungs Schraube	Sıkma Civatası Clamp Screw Torx-Schraube	Anahtar Torx Key Torx-Schlüssel
			ØD	Z	M	L	L1	L2				
VT120	●	D25 Z02 M12 RD--12	25	2	M12	55	33	22				
VT123	●	D32 Z03 M16 RD--12	32	3	M16	60	36	24				
VT126	●	D35 Z03 M16 RD--12	35	3	M16	60	36	24				
VT128	●	D40 Z04 M16 RD--12	40	4	M16	60	36	24				
VT130	●	D42 Z04 M16 RD--12	42	4	M16	60	36	24				

● Stokta / In Stock / Lager ○ Sınırlı Stok / Limited Stock / Begrenzte Lagerhaltung

RDMT 12T3 ISO'dur./ RDMT 12T3 is ISO. / Kompatible für ISO WP

**V4**  
**APKT 11T3 R390**

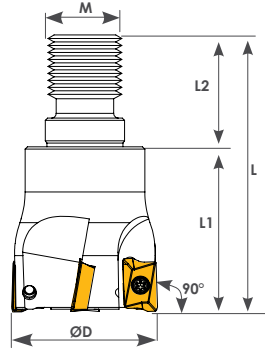

Ölçüler (mm) Dimensions(mm) Abmessungen (mm)		APKT 11T3 R390	
L	S		
11	3,18		

Sipariş Kodu Order Code Best.-Nr.	Stok/Stock/Lager	Ürün Kodu Product Code Produkt-Code	Ölçüler (mm) Dimensions(mm) Abmessungen (mm)						Kullanılan Uç Insert WSP	Sıkma Civatası Clamp Screw Torx-Schraube	Anahtar Torx Key Torx-Schlüssel
			ØD	Z	M	L	L1	L2			
VT210	●	D16 Z02 M08 AP--11	16	2	8	55	33	17	APKT 11T3 R390 SNDVK	TC063 M2,5x7	T8
VT211	●	D20 Z03 M10 AP--11	20	3	10	55	33	17			
VT212	●	D25 Z03 M12 AP--11	25	3	12	55	33	22			
VT213	●	D32 Z03 M16 AP--11	32	3	16	60	36	24			

SNDVK ucuna uygundur. / Compatible with SNDVK insert. / Kompatible für SNDVK WP

**V6**  
**XOMX 1204**

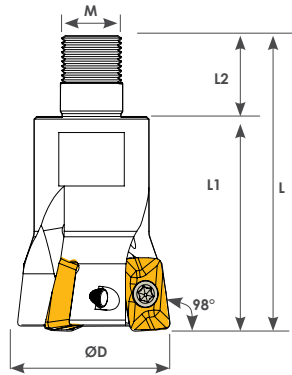

Ölçüler (mm) Dimensions(mm) Abmessungen (mm)		XO-- 1204	
L	S		
12	5,06		

Sipariş Kodu Order Code Best.-Nr.	Stok/Stock/Lager	Ürün Kodu Product Code Produkt-Code	Ölçüler (mm) Dimensions(mm) Abmessungen (mm)						Kullanılan Uç Insert WSP	Sıkma Civatası Clamp Screw Torx-Schraube	Anahtar Torx Key Torx-Schlüssel
			ØD	Z	M	L	L1	L2			
VT220	●	D24,6 Z02 M10 XO--12	24,6	2	M10	55	33	22	XO-- 1204 SCO	TC069 M3,5x8,5	T10
VT222	●	D31,6 Z03 M12 XO--12	31,6	3	M12	60	36	24			

● Stokta/ In Stock / Lager ○ Sınırlı Stok / Limited Stock / Begrenzte Lagerhaltung  
SCO ucuna uygundur. / Compatible with SCO insert. / Kompatible für KRLY WP



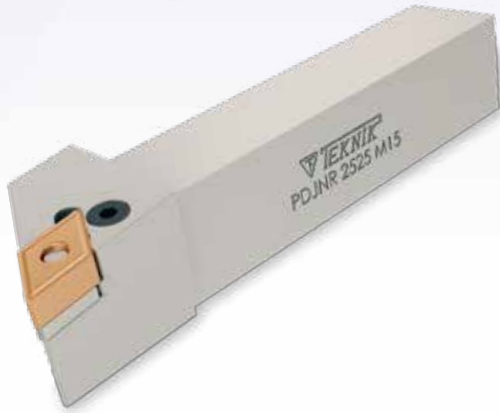

تکنیک تولز

ابزار آلات صنعتی - تراشکاری و ماشینکاری  
۶۶۷۱۱۶۷ - ۶۶۷۱۱۶۹

تهران، خ امام خمینی، م حسن آباد، پاساژ هشت گنبد، شماره ۱۵

P-A Sistem Kater  
P-A System

## 93° PDJNR

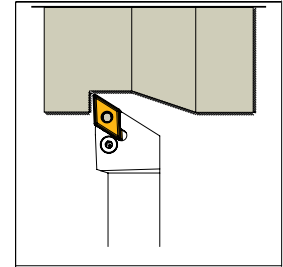
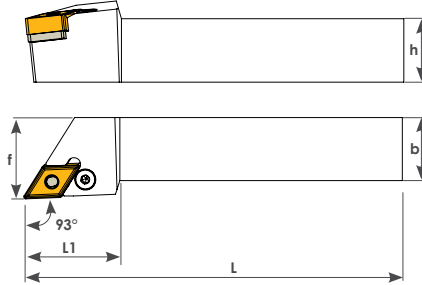

Sipariş Kodu Order Code Best.-Nr.	Stok/Stock/Lager	Ürün Kodu Product Code Produkt-Code	Ölçüler (mm) Dimensions (mm) Abmessungen (mm)					Kullanılan Uç Insert WSP	Sıkma Civatası Clamp Screw Klemm-Schraube	Altılık Shim U-Platte	Levyeye Sacı Lock Pin Rohrstift	Levyeye Lever Kniehebel	Anahtar Allen Key Inbuss-Schlüssel
			L	L1	h	f	b						
P110	●	PDJNR 2020 K15	125	35	20	25	20	DNMG 1506	TH-822 M8	TA014-1			
P112	●	PDJNR 2525 M15	150	38	25	32	25	DNMG 1506	TH-825 M8	TA014-1	TS-4	TL4B	3 Allen
P114	●	PDJNR 3232 P15	170	38	32	40	32						

## 93° PDJNL

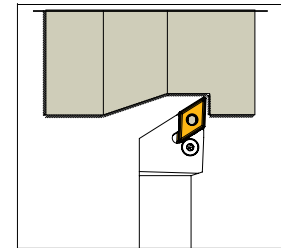
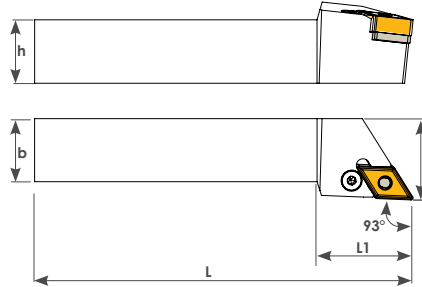

Sipariş Kodu Order Code Best.-Nr.	Stok/Stock/Lager	Ürün Kodu Product Code Produkt-Code	Ölçüler (mm) Dimensions (mm) Abmessungen (mm)					Kullanılan Uç Insert WSP	Sıkma Civatası Clamp Screw Klemm-Schraube	Altılık Shim U-Platte	Levyeye Sacı Lock Pin Rohrstift	Levyeye Lever Kniehebel	Anahtar Allen Key Inbuss-Schlüssel
			L	L1	h	f	b						
P122	●	PDJNL 2020 K15	125	35	20	25	20	DNMG 1506	TH-822 M8	TA014-1			
P124	●	PDJNL 2525 M15	150	38	25	32	25	DNMG 1506	TH-825 M8	TA014-1	TS-4	TL4B	3 Allen
P126	●	PDJNL 3232 P15	170	38	32	40	32						

● Stokta / In Stock / Lager ○ Sınırlı Stok / Limited Stock / Begrenzte Lagerhaltung

## 95° PCLNR

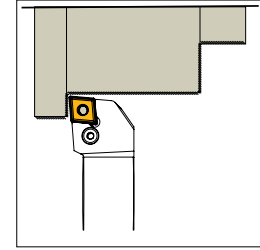
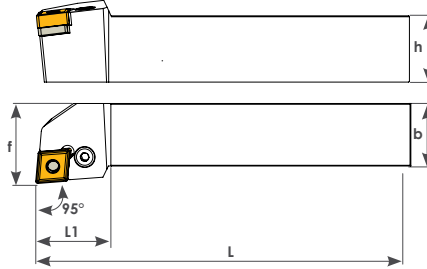

Sipariş Kodu Order Code Best.-Nr.	Stok/Stock/Lager	Ürün Kodu Product Code Produkt-Code	Ölçüler (mm) Dimensions (mm) Abmessungen (mm)					Kullanılan Uç Insert WSP	Sıkma Civatası Clamp Screw Klemm-Schraube	Altlık Shim U-Platte	Levye Sacı Lock Pin Rohrstift	Levye Lever Kniehebel	Anahtar Allen Key Inbuss-Schlüssel
			L	L1	h	f	b						
P129	●	PCLNR 1616 H12	100	28	16	20	16	CNMG 1204	TH818 M8	TA016-1	TS4	TL4	3 Allen
P130	●	PCLNR 2020 K12	125	30	20	25	20	CNMG 1204	TH821 M8	TA016-1	TS4	TL4	
P132	●	PCLNR 2525 M12	150	30	25	32	25						
P134	●	PCLNR 3232 P12	170	30	32	40	32						



## 95° PCLNL

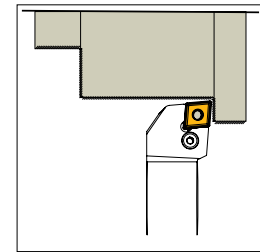
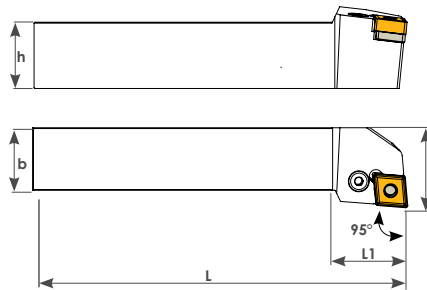

Sipariş Kodu Order Code Best.-Nr.	Stok/Stock/Lager	Ürün Kodu Product Code Produkt-Code	Ölçüler (mm) Dimensions (mm) Abmessungen (mm)					Kullanılan Uç Insert WSP	Sıkma Civatası Clamp Screw Klemm-Schraube	Altlık Shim U-Platte	Levye Sacı Lock Pin Rohrstift	Levye Lever Kniehebel	Anahtar Allen Key Inbuss-Schlüssel
			L	L1	h	f	b						
P139	●	PCLNL 1616 H12	100	28	16	20	16	CNMG 1204	TH 818 M8	TA016-1	TS4	TL4	3 Allen
P140	●	PCLNL 2020 K12	125	30	20	25	20	CNMG 1204	TH821 M8	TA016-1	TS4	TL4	
P142	●	PCLNL 2525 M12	150	30	25	32	25						
P144	●	PCLNL 3232 P12	170	30	32	40	32						

● Stokta / In Stock / Lager ○ Sınırlı Stok / Limited Stock / Begrenzte Lagerhaltung

## 95° PWLNR 08

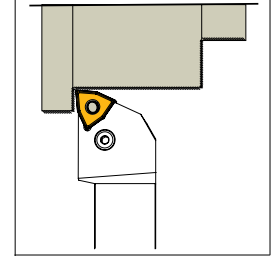
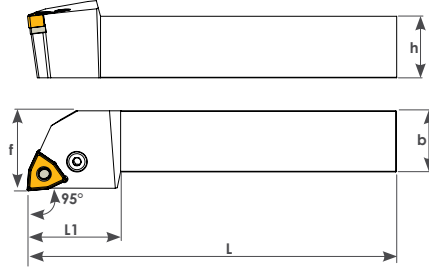

Sipariş Kodu Order Code Best.-Nr.	Stok/Stock/Lager	Ürün Kodu Product Code Produkt-Code	Ölçüler (mm) Dimensions (mm) Abmessungen (mm)					Kullanılan Uç Insert WSP	Sıkma Cıvatası Clamp Screw Klemm-Schraube	Altlık Shim U-Platte	Levy Sacı Lock Pin Rohrstift	Levy Lever Kniehebel	Anahtar Allen Key Inbuss-Schlüssel
			L	L1	h	f	b						
P150	●	PWLNR 2020 K08	125	30	20	25	20	WNGM 0804	TH-821 M8	TA020-1	TS4	TL4	3 Allen
P151	●	PWLNR 2525 M08	150	38	25	32	25						
P152	●	PWLNR 3232 P08	170	38	32	40	32						

## 95° PWLNL 08

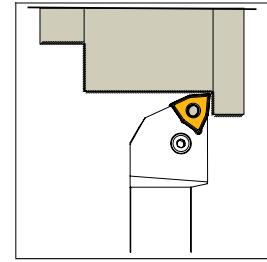
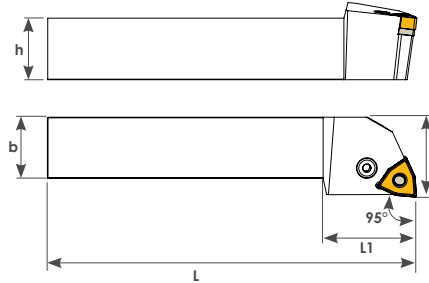

Sipariş Kodu Order Code Best.-Nr.	Stok/Stock/Lager	Ürün Kodu Product Code Produkt-Code	Ölçüler (mm) Dimensions (mm) Abmessungen (mm)					Kullanılan Uç Insert WSP	Sıkma Cıvatası Clamp Screw Klemm-Schraube	Altlık Shim U-Platte	Levy Sacı Lock Pin Rohrstift	Levy Lever Kniehebel	Anahtar Allen Key Inbuss-Schlüssel
			L	L1	h	f	b						
P155	●	PWLNL 2020 K08	125	30	20	25	20	WNGM 0804	TH-821 M8	TA020-1	TS4	TL4	3 Allen
P156	●	PWLNL 2525 M08	150	38	25	32	25						
P157	●	PWLNL 3232 P08	170	38	32	40	32						

● Stokta / In Stock / Lager ○ Sınırlı Stok / Limited Stock / Begrenzte Lagerhaltung

## 95° PWLNR 06

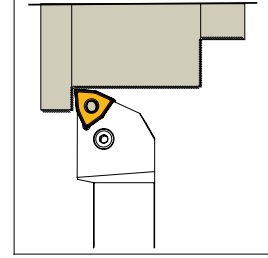
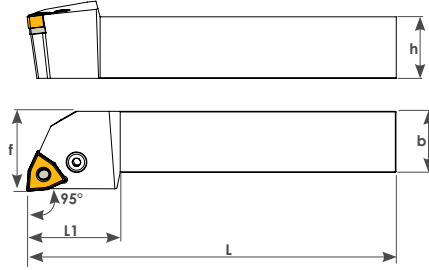

Sipariş Kodu Order Code Best.-Nr.	Stok/Stock/Lager	Ürün Kodu Product Code Produkt-Code	Ölçüler (mm) Dimensions(mm) Abmessungen (mm)					Kullanılan Uç Insert WSP	Sıkma Cıvatası Clamp Screw Klemm-Schraube	Altılık Shim U-Platte	Levyé Sacı Lock Pin Rohrstift	Levyé Lever Kniehebel	Anahtar Allen Key Inbuss-Schlüssel
			L	L1	h	f	b						
P158	●	PWLNR 1616 H06	100	30	16	20	16	WNMG 0604	TH-617 M6	TA021	TS3	TL3	2,5 Allen
P160	●	PWLNR 2020 K06	125	30	20	25	20						
P161	●	PWLNR 2525 M06	150	30	25	32	25						

**تکنیک تولز**  
ابزار آلات صنعتی، تراشکاری و قالبسازی  
۱۵ شماره ۱۵  
تهران، ج امام خمینی، م حسن آباد، پاساژ هشت گنبد، شماره ۱۵

## 95° PWLNL 06

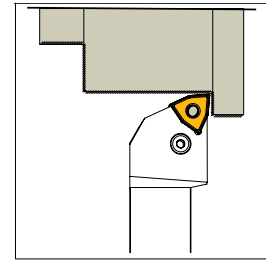
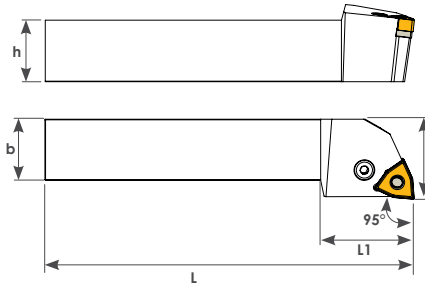

Sipariş Kodu Order Code Best.-Nr.	Stok/Stock/Lager	Ürün Kodu Product Code Produkt-Code	Ölçüler (mm) Dimensions(mm) Abmessungen (mm)					Kullanılan Uç Insert WSP	Sıkma Cıvatası Clamp Screw Klemm-Schraube	Altılık Shim U-Platte	Altılık Pimi Lock Pin Rohrstift	Levyé Lever Kniehebel	Anahtar Allen Key Inbuss-Schlüssel
			L	L1	h	f	b						
P164	●	PWLNL 1616 H06	100	30	16	20	16	WNMG 0604	TH-617 M6	TA021	TS3	TL3	2,5 Allen
P165	●	PWLNL 2020 K06	125	30	20	25	20						
P166	●	PWLNL 2525 M06	150	30	25	32	25						

● Stokta / In Stock / Lager ○ Sınırlı Stok / Limited Stock / Begrenzte Lagerhaltung

## 93° PDUNR

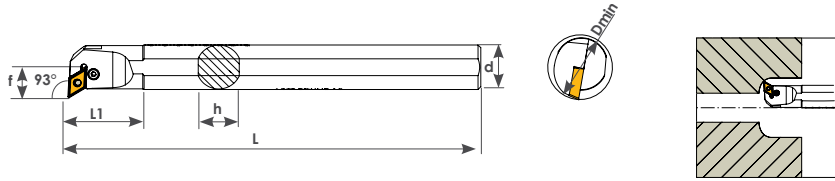

Sipariş Kodu Order Code Best.-Nr.	Stok/Stock/Lager	Ürün Kodu Product Code Produkt-Code	Ölçüler (mm) Dimensions(mm) Abmessungen (mm)						Kullanılan Uç Insert WSP	Sıkma Cıvatası Clamp Screw Klemm-Schraube	Altılık Shim U-Platte	Levyeye Sacı Lock Pin Rohrstift	Levyeye Lever Kniehebel	Anahtar Allen Key Inbuss-Schlüssel
			Dmin	d	L	L1	f	h						
P300	●	S25S PDUNR 15	32	25	250	50	17	23	DNMG 1506	TH6134A M6	---	---	TL4A	2,5 Allen
P302	●	S32T PDUNR 15	40	32	300	55	22	30		TH822 M8	TA014-1	TS-4	TL4B	3 Allen
P304	●	S40T PDUNR 15	50	40	300	55	27	38						



## 93° PDUNL

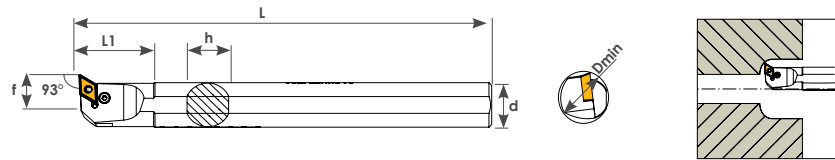

Sipariş Kodu Order Code Best.-Nr.	Stok/Stock/Lager	Ürün Kodu Product Code Produkt-Code	Ölçüler (mm) Dimensions(mm) Abmessungen (mm)						Kullanılan Uç Insert WSP	Sıkma Cıvatası Clamp Screw Klemm-Schraube	Altılık Shim U-Platte	Levyeye Sacı Lock Pin Rohrstift	Levyeye Lever Kniehebel	Anahtar Allen Key Inbuss-Schlüssel
			Dmin	d	L	L1	f	h						
P310	●	S25S PDUNL 15	32	25	250	50	17	23	DNMG 1506	TH6134A M6	---	---	TL4A	2,5 Allen
P312	●	S32T PDUNL 15	40	32	300	55	22	30		TH822 M8	TA014-1	TS-4	TL4B	3 Allen
P314	●	S40T PDUNL 15	50	40	300	55	27	38						

● Stokta / In Stock / Lager ○ Sınırlı Stok / Limited Stock / Begrenzte Lagerhaltung



## 95° PCLNR

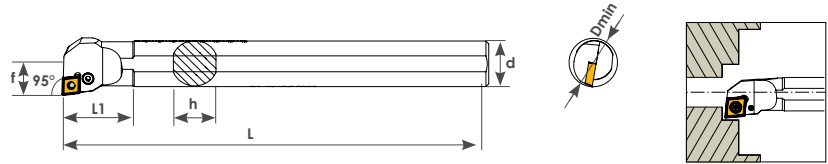

Sipariş Kodu Order Code Best.-Nr.	Stok/Stock/Lager	Ürün Kodu Product Code Produkt-Code	Ölçüler (mm) Dimensions (mm) Abmessungen (mm)						Kullanılan Uç Insert WSP	Sıkma Civatası Clamp Screw Klemm-Schraube	Altlık Shim U-Platte	Levye Sacı Lock Pin Rohrstift	Levye Lever Kniehebel	Anahtar Allen Key Inbuss-Schlüssel
			Dmin	d	L	L1	f	h						
P340	●	S25S PCLNR 12	32	25	250	50	17	23	CNMG 1204	TH6134A M6	---	---	TL4A	2,5 Allen
P342	●	S32T PCLNR 12	40	32	300	50	22	30		TH821 M8	TA016-1	TS-4	TL4	3 Allen
P344	●	S40T PCLNR 12	50	40	300	55	27	38						

## 95° PCLNL



Sipariş Kodu Order Code Best.-Nr.	Stok/Stock/Lager	Ürün Kodu Product Code Produkt-Code	Ölçüler (mm) Dimensions (mm) Abmessungen (mm)						Kullanılan Uç Insert WSP	Sıkma Civatası Clamp Screw Klemm-Schraube	Altlık Shim U-Platte	Levye Sacı Lock Pin Rohrstift	Levye Lever Kniehebel	Anahtar Allen Key Inbuss-Schlüssel
			Dmin	d	L	L1	f	h						
P350	●	S25S PCLNL 12	32	25	250	50	17	23	CNMG 1204	TH6134A M6	---	---	TL4A	2,5 Allen
P352	●	S32T PCLNL 12	40	32	300	50	22	30		TH821 M8	TA016-1	TS-4	TL4	3 Allen
P354	●	S40T PCLNL 12	50	40	300	55	27	38						

● Stokta / In Stock / Lager ○ Sınırlı Stok / Limited Stock / Begrenzte Lagerhaltung

## 95° PWLNR 08

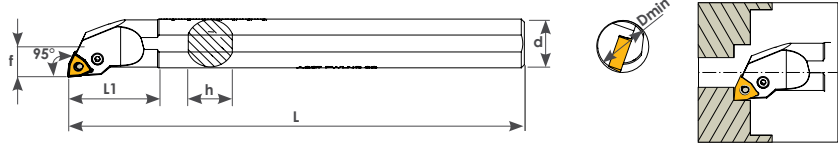
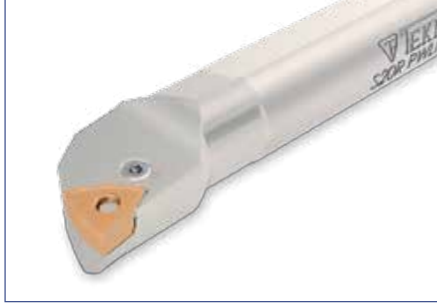

Sipariş Kodu Order Code Best.-Nr.	Stok/Stock/Lager	Ürün Kodu Product Code Produkt-Code	Ölçüler (mm) Dimensions (mm) Abmessungen (mm)						Kullanılan Uç Insert WSP	Sıkma Civatası Clamp Screw Klemm-Schraube	Altlık Shim U-Platte	Levyeye Sacı Lock Pin Rohrstift	Levyeye Lever Kniehebel	Anahtar Allen Key Inbuss-Schlüssel
			Dmin	d	L	L1	f	h						
P360	●	S25S PWLNR 08	32	25	250	50	17	23	WNGM 0804	TH6134A M6	---	---	TL4A	2,5 Allen
P362	●	S32T PWLNR 08	40	32	300	60	22	30		TH821 M8	TA020-1	TS-4	TL4	3 Allen
P364	●	S40T PWLNR 08	50	40	300	60	27	38						



## 95° PWLNL 08

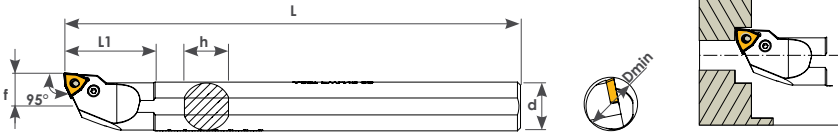
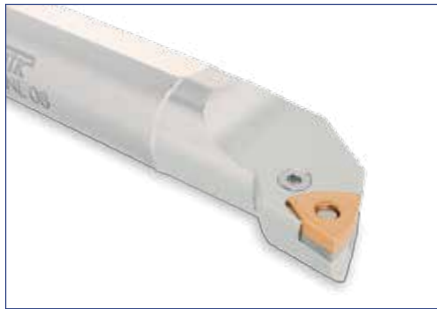

Sipariş Kodu Order Code Best.-Nr.	Stok/Stock/Lager	Ürün Kodu Product Code Produkt-Code	Ölçüler (mm) Dimensions (mm) Abmessungen (mm)						Kullanılan Uç Insert WSP	Sıkma Civatası Clamp Screw Klemm-Schraube	Altlık Shim U-Platte	Levyeye Sacı Lock Pin Rohrstift	Levyeye Lever Kniehebel	Anahtar Allen Key Inbuss-Schlüssel
			Dmin	d	L	L1	f	h						
P370	●	S25S PWLNL 08	32	25	250	50	17	23	WNGM 0804	TH6134A M6	---	---	TL4A	2,5 Allen
P372	●	S32T PWLNL 08	40	32	300	60	22	30		TH821 M8	TA020-1	TS-4	TL4	3 Allen
P374	●	S40T PWLNL 08	50	40	300	60	27	38						

● Stokta / In Stock / Lager ○ Sınırlı Stok / Limited Stock / Begrenzte Lagerhaltung

## 95° PWLNR 06

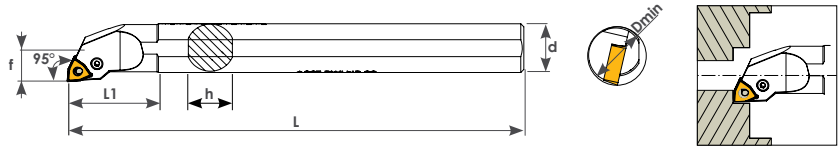

Sipariş Kodu Order Code Best.-Nr.	Stok/Stock/Lager	Ürün Kodu Product Code Produkt-Code	Ölçüler (mm) Dimensions(mm) Abmessungen (mm)						Kullanılan Uç Insert WSP	Sıkma Cıvatası Clamp Screw Klemm-Schraube	Altlık Shim U-Platte	Levye Sacı Lock Pin Rohrstift	Levye Lever Kniehebel	Anahtar Allen Key Inbuss-Schlüssel
			Dmin	d	L	L1	f	h						
P380	●	S16R PWLNR 06	21	16	200	40	11	15	WNGM 0604	TH512 M5	TA021	TS3	TL3B	2 Allen
P382	●	S20R PWLNR 06	25	20	200	40	13	18						



## 95° PWLNL 06

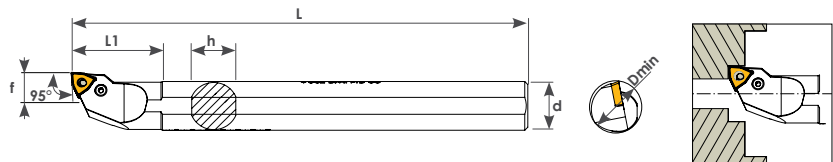
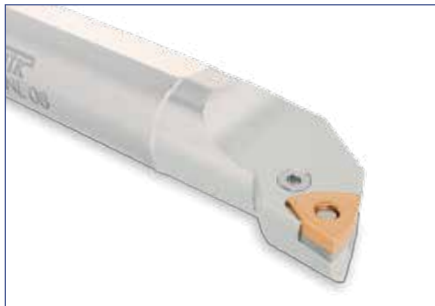

Sipariş Kodu Order Code Best.-Nr.	Stok/Stock/Lager	Ürün Kodu Product Code Produkt-Code	Ölçüler (mm) Dimensions(mm) Abmessungen (mm)						Kullanılan Uç Insert WSP	Sıkma Cıvatası Clamp Screw Klemm-Schraube	Altlık Shim U-Platte	Levye Sacı Lock Pin Rohrstift	Levye Lever Kniehebel	Anahtar Allen Key Inbuss-Schlüssel
			Dmin	d	L	L1	f	h						
P388	●	S16R PWLNL 06	21	16	200	40	11	15	WNGM 0604	TH512 M5	TA021	TS3	TL3B	2 Allen
P390	●	S20R PWLNL 06	25	20	200	40	13	18						

● Stokta / In Stock / Lager ○ Sınırlı Stok / Limited Stock / Begrenzte Lagerhaltung

## 93° PDUNR

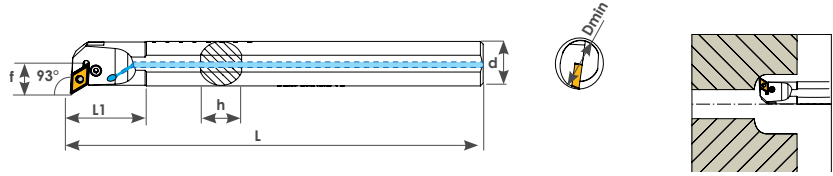

Sipariş Kodu Order Code Best.-Nr.	Stok/Stock/Lager	Ürün Kodu Product Code Produkt-Code	Ölçüler (mm) Dimensions(mm) Abmessungen (mm)						Kullanılan Uç Insert WSP	Sıkma Civatası Clamp Screw Klemm-Schraube	Altlık Shim U-Platte	Levye Sacı Lock Pin Rohrstift	Levye Lever Kniehebel	Anahtar Allen Key Inbuss-Schlüssel
			Dmin	d	L	L1	f	h						
AP300	●	A25S PDUNR 15	32	25	250	50	17	23	DNMG 1506	TH6134A M6	---	---	TL4A	2,5 Allen
AP302	●	A32T PDUNR 15	40	32	300	55	22	30		TH822 M8	TA014-1	TS-4	TL4B	3 Allen
AP304	●	A40T PDUNR 15	50	40	300	55	27	38						

## 93° PDUNL

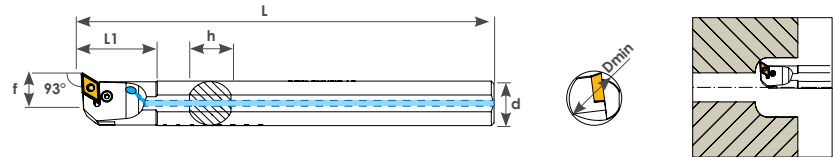
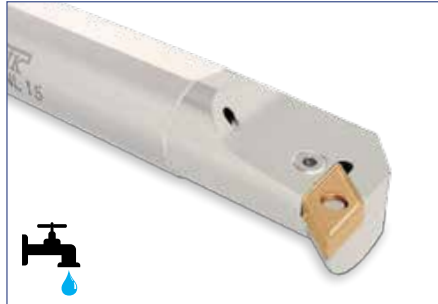

Sipariş Kodu Order Code Best.-Nr.	Stok/Stock/Lager	Ürün Kodu Product Code Produkt-Code	Ölçüler (mm) Dimensions(mm) Abmessungen (mm)						Kullanılan Uç Insert WSP	Sıkma Civatası Clamp Screw Klemm-Schraube	Altlık Shim U-Platte	Levye Sacı Lock Pin Rohrstift	Levye Lever Kniehebel	Anahtar Allen Key Inbuss-Schlüssel
			Dmin	d	L	L1	f	h						
AP310	●	A25S PDUNL 15	32	25	250	50	17	23	DNMG 1506	TH6134A M6	---	---	TL4A	2,5 Allen
AP312	●	A32T PDUNL 15	40	32	300	55	22	30		TH822 M8	TA014-1	TS-4	TL4B	3 Allen
AP314	●	A40T PDUNL 15	50	40	300	55	27	38						

● Stokta/ In Stock / Lager ○ Sınırlı Stok / Limited Stock / Begrenzte Lagerhaltung

## 95° PCLNR

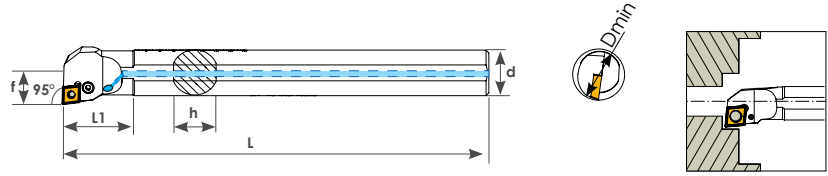

Sipariş Kodu Order Code Best.-Nr.	Stok/Stock/Lager	Ürün Kodu Product Code Produkt-Code	Ölçüler (mm) Dimensions (mm) Abmessungen (mm)						Kullanılan Uç Insert WSP	Sıkma Cıvatası Clamp Screw Klemm-Schraube	Altlık Shim U-Platte	Levy Sacı Lock Pin Rohrstift	Levy Lever Kniehebel	Anahtar Allen Key Inbuss-Schlüssel
			Dmin	d	L	L1	f	h						
AP340	●	A25S PCLNR 12	32	25	250	50	17	23	CNMG 1204	TH6134A M6	---	---	TL4A	2,5 Allen
AP342	●	A32T PCLNR 12	40	32	300	50	22	30		TH821 M8	TA016-1	TS-4	TL4	3 Allen
AP344	●	A40T PCLNR 12	50	40	300	55	27	38						



## 95° PCLNL

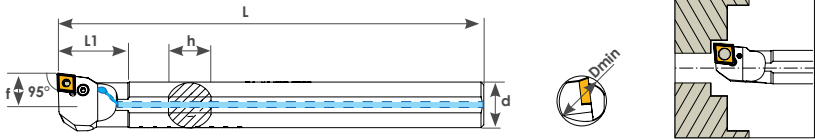

Sipariş Kodu Order Code Best.-Nr.	Stok/Stock/Lager	Ürün Kodu Product Code Produkt-Code	Ölçüler (mm) Dimensions (mm) Abmessungen (mm)						Kullanılan Uç Insert WSP	Sıkma Cıvatası Clamp Screw Klemm-Schraube	Altlık Shim U-Platte	Levy Sacı Lock Pin Rohrstift	Levy Lever Kniehebel	Anahtar Allen Key Inbuss-Schlüssel
			Dmin	d	L	L1	f	h						
AP350	●	A25S PCLNL 12	32	25	250	50	17	23	CNMG 1204	TH6134A M6	---	---	TL4A	2,5 Allen
AP352	●	A32T PCLNL 12	40	32	300	50	22	30		TH821 M8	TA016-1	TS-4	TL4	3 Allen
AP354	●	A40T PCLNL 12	50	40	300	55	27	38						

● Stokta / In Stock / Lager ○ Sınırlı Stok / Limited Stock / Begrenzte Lagerhaltung

## 95° PWLNR 08

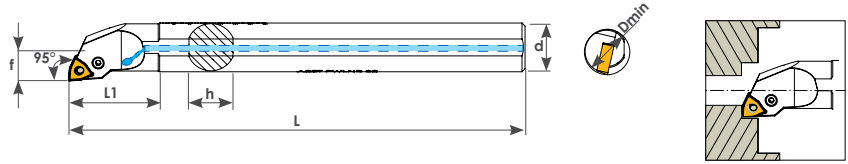
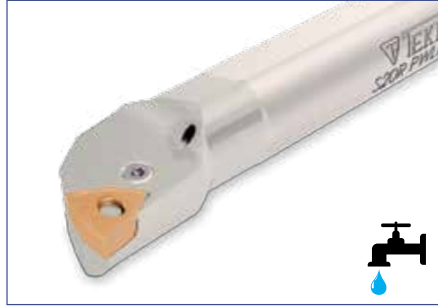

Sipariş Kodu Order Code Best.-Nr.	Stok/Stock/Lager	Ürün Kodu Product Code Produkt-Code	Ölçüler (mm) Dimensions (mm) Abmessungen (mm)						Kullanılan Uç Insert WSP	Sıkma Cıvatası Clamp Screw Klemm-Schraube	Altlık Shim U-Platte	Levye Sacı Lock Pin Rohrstift	Levye Lever Kniehebel	Anahtar Allen Key Inbuss-Schlüssel
			Dmin	d	L	L1	f	h						
AP360	●	A25S PWLNR 08	32	25	250	50	17	23	WNGM 0804	TH6134A M6	---	---	TL4A	2,5 Allen
AP362	●	A32T PWLNR 08	40	32	300	60	22	30		TH821 M8	TA020-1	TS-4	TL4	3 Allen
AP364	●	A40T PWLNR 08	50	40	300	60	27	38						

## 95° PWLNL 08

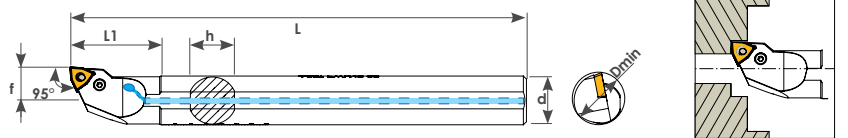
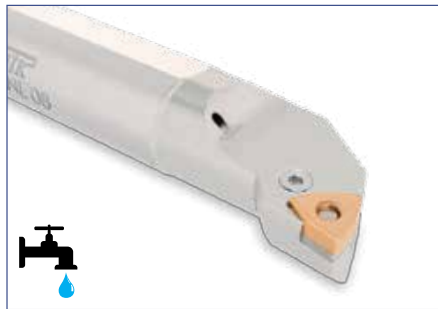

Sipariş Kodu Order Code Best.-Nr.	Stok/Stock/Lager	Ürün Kodu Product Code Produkt-Code	Ölçüler (mm) Dimensions (mm) Abmessungen (mm)						Kullanılan Uç Insert WSP	Sıkma Cıvatası Clamp Screw Klemm-Schraube	Altlık Shim U-Platte	Levye Sacı Lock Pin Rohrstift	Levye Lever Kniehebel	Anahtar Allen Key Inbuss-Schlüssel
			Dmin	d	L	L1	f	h						
AP370	●	A25S PWLNL 08	32	25	250	50	17	23	WNGM 0804	TH6134A M6	---	---	TL4A	2,5 Allen
AP372	●	A32T PWLNL 08	40	32	300	60	22	30		TH821 M8	TA020-1	TS-4	TL4	3 Allen
AP374	●	A40T PWLNL 08	50	40	300	60	27	38						

● Stokta / In Stock / Lager ○ Sınırlı Stok / Limited Stock / Begrenzte Lagerhaltung

## 95° PWLNR 06

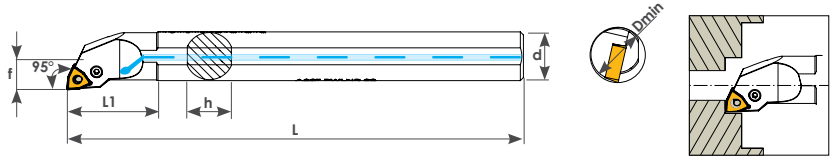
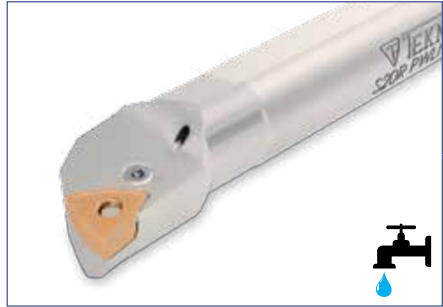

Sipariş Kodu Order Code Best.-Nr.	Stok/Stock/Lager	Ürün Kodu Product Code Produkt-Code	Ölçüler (mm) Dimensions(mm) Abmessungen (mm)						Kullanılan Uç Insert WSP	Sıkma Cıvatası Clamp Screw Klemm- Schraube	Aflık Shim U-Platte	Levyeye Sacı Lock Pin Rohrstift	Levyeye Lever Kniehebel	Anahtar Allen Key Inbuss-Schlüssel
			Dmin	d	L	L1	f	h						
AP380	●	A16R PWLNR 06	21	16	200	40	11	15	WNGM 0604	TH512 M5	TA021	TS3	TL3B	2 Allen
AP382	●	A20R PWLNR 06	25	20	200	40	13	18						



## 95° PWLNL 06

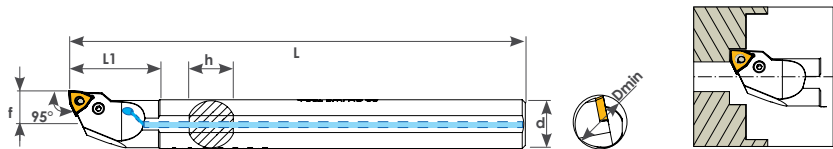

Sipariş Kodu Order Code Best.-Nr.	Stok/Stock/Lager	Ürün Kodu Product Code Produkt-Code	Ölçüler (mm) Dimensions(mm) Abmessungen (mm)						Kullanılan Uç Insert WSP	Sıkma Cıvatası Clamp Screw Klemm- Schraube	Aflık Shim U-Platte	Levyeye Sacı Lock Pin Rohrstift	Levyeye Lever Kniehebel	Anahtar Allen Key Inbuss-Schlüssel
			Dmin	d	L	L1	f	h						
AP388	●	A16R PWLNL 06	21	16	200	40	11	15	WNGM 0604	TH512 M5	TA021	TS3	TL3B	2 Allen
AP390	●	A20R PWLNL 06	25	20	200	40	13	18						

● Stokta / In Stock / Lager ○ Sınırlı Stok / Limited Stock / Begrenzte Lagerhaltung

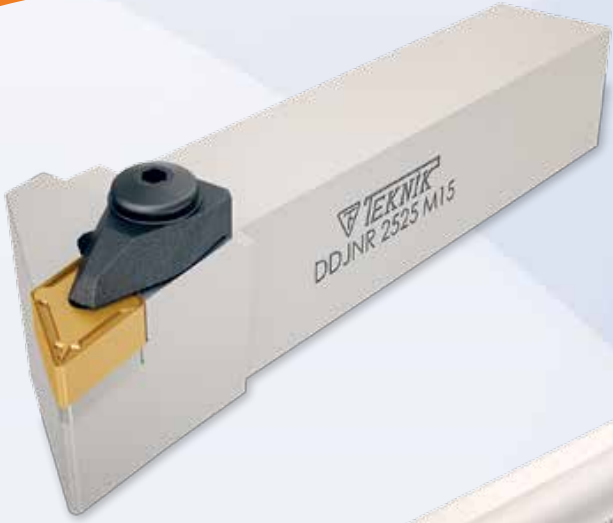

**D-M-C Sistem Kater**  
D-M-C System



## 93° DDJNR

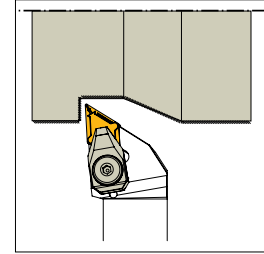
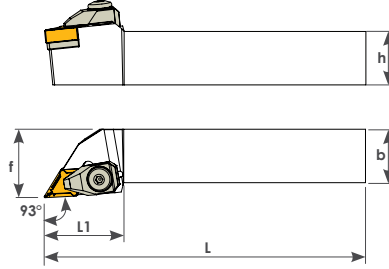

Sipariş Kodu Order Code Best.-Nr.	Stok/Stock/Lager	Ürün Kodu Product Code Produkt-Code	Ölçüler (mm) Dimensions(mm) Abmessungen (mm)					Kullanılan Uç Insert WSP	Baskı Cıvatası Locking Screw Verriegelungs Schraube	Altlık Shim U-Platte	Altlık Cıvatası Shim Screw U-Platte Schraube	Baskı Kepi Clamp Spann pratze	Yay Spring Feder	Pul Washer U-Scheibe	Anahtar Allen Key Inbuss- Schlüssel
			L	L1	h	f	b								
D167	●	DDJNR 2020 K11	125	35	20	25	20	DN-- 1104	TC046 M5	TA030	TC075 M4x11	BK024	BY041	BSP031	3 Allen
D168	●	DDJNR 2525 M11	150	35	25	32	25								
D170	●	DDJNR 2020 K15	125	38	20	25	20	DN-- 1506	TC044 M6	TA014-1	TC038 M4x10	BK020	BY040	BSP030	5 Allen
D172	●	DDJNR 2525 M15	150	38	25	32	25								
D174	●	DDJNR 3232 P15	170	38	32	40	32								

## 93° DDJNL

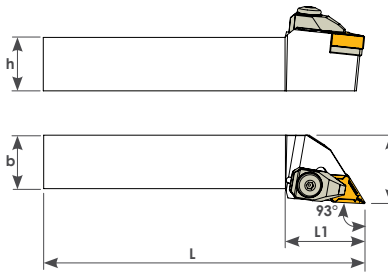

ابزار آلات صنعتی ، تراشکاری و ماشینکاری  
۶۶۷۱۱۹۶۷ - ۶۶۷۱۱۷۲۹  
تهران، خ امام خمینی، م حسن آباد، پاساژ هشت گنبد، شماره ۱۵

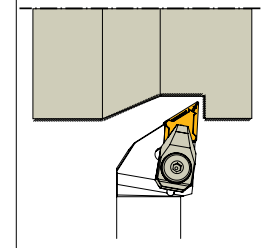

Sipariş Kodu Order Code Best.-Nr.	Stok/Stock/Lager	Ürün Kodu Product Code Produkt-Code	Ölçüler (mm) Dimensions(mm) Abmessungen (mm)					Kullanılan Uç Insert WSP	Baskı Cıvatası Locking Screw Verriegelungs Schraube	Altlık Shim U-Platte	Altlık Cıvatası Shim Screw U-Platte Schraube	Baskı Kepi Clamp Spann pratze	Yay Spring Feder	Pul Washer U-Scheibe	Anahtar Allen Key Inbuss- Schlüssel
			L	L1	h	f	b								
D307-1	●	DDJNL 2020 K11	125	35	20	25	20	DN-- 1104	TC046 M5	TA030	TC075 M4x11	BK024	BY041	BSP031	3 Allen
D308	●	DDJNL 2525 M11	150	35	25	32	25								
D310	●	DDJNL 2020 K15	125	38	20	25	20	DN-- 1506	TC044 M6	TA014-1	TC038 M4x10	BK020	BY040	BSP030	5 Allen
D312	●	DDJNL 2525 M15	150	38	25	32	25								
D314	●	DDJNL 3232 P15	170	38	32	40	32								

● Stokta/ In Stock / Lager ○ Sınırlı Stok / Limited Stock / Begrenzte Lagerhaltung

## 62,5° DDNNN

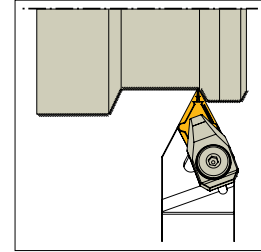
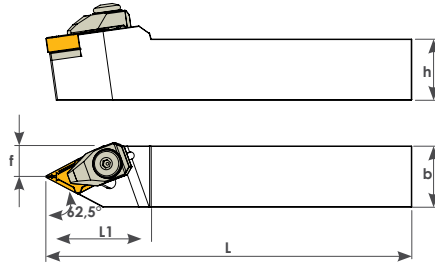

Sipariş Kodu Order Code Best.-Nr.	Stok/Stock/Lager	Ürün Kodu Product Code Produkt-Code	Ölçüler (mm) Dimensions (mm) Abmessungen (mm)					Kullanılan Uç Insert WSP	Baskı Civatası Locking Screw Verriegelungs Schraube	Altlık Shim U-Platte	Altlık Civatası Shim Screw U-Platte Schraube	Baskı Kepi Clamp Spannpratze	Yay Spring Feder	Pul Washer U-Scheibe	Anahtar Allen Key Inbuss-Schlüssel
			L	L1	h	f	b								
D104	●	DDNNN 2020 K15	125	42	20	10	20	DN-- 1506	TC044 M6	TA014-1	TC038 M4x10	BK020	BY040	BSP030	4 Allen
D106	●	DDNNN 2525 M15	150	42	25	12,5	25								
D109	●	DDNNN 3232 P15	170	42	32	25	32								

● Stokta / In Stock / Lager ○ Sınırlı Stok / Limited Stock / Begrenzte Lagerhaltung

**تکنیک تولز**

ابزار آلات صنعتی، تراشکاری و قابلسازی

۶۶۶۱۱۶۶ - ۶۶۶۱۱۶۶

تهران، خ امام خمینی، م حسن آباد، پاساژ هشت گنبد، شماره ۱۵



## 107,5° DDHNR

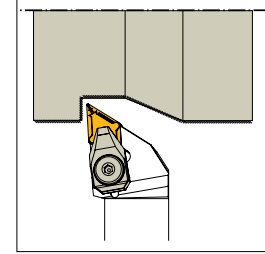
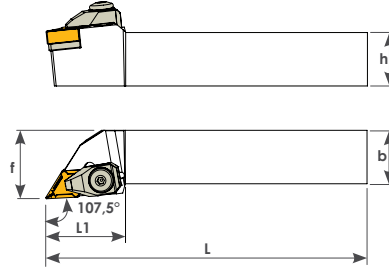

Sipariş Kodu Order Code Best.-Nr.	Stok/Stock/Lager	Ürün Kodu Product Code Produkt-Code	Ölçüler (mm) Dimensions(mm) Abmessungen (mm)					Kullanılan Uç Insert WSP	Baskı Civatası Locking Screw Verriegelungs Schraube	Altlık Shim U-Platte	Altlık Civatası Shim Screw U-Platte Schraube	Baskı Kepi Clamp Spann pratze	Yay Spring Feder	Pul Washer U-Scheibe	Anahtar Allen Key Inbuss- Schlüssel
			L	L1	h	f	b								
D096	●	DDHNR 2020 K15	125	38	20	25	20	DN-- 1506	TC044 M6	TA014-1	TC038 M4x10	BK020	BY040	BSP030	4 Allen
D097	●	DDHNR 2525 M15	150	38	25	32	25								
D098	●	DDHNR 3232 P15	170	38	32	40	32								

**تکنیک تولز**  
ایزار آلات صنعتی، تراشکاری و فالنساری  
۶۶۷۱۹۶۷ - ۶۶۷۱۱۲۲۹  
تهران، خ امام خمینی، م حسن آباد، پاساژ هشت گنبد، شماره ۱۵

## 107,5° DDHNL

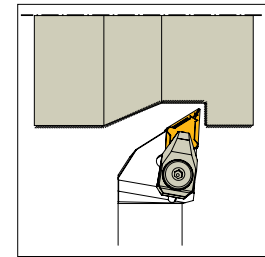
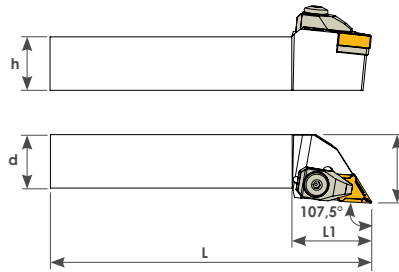

Sipariş Kodu Order Code Best.-Nr.	Stok/Stock/Lager	Ürün Kodu Product Code Produkt-Code	Ölçüler (mm) Dimensions(mm) Abmessungen (mm)					Kullanılan Uç Insert WSP	Baskı Civatası Locking Screw Verriegelungs Schraube	Altlık Shim U-Platte	Altlık Civatası Shim Screw U-Platte Schraube	Baskı Kepi Clamp Spann pratze	Yay Spring Feder	Pul Washer U-Scheibe	Anahtar Allen Key Inbuss- Schlüssel
			L	L1	h	f	b								
D295	●	DDHNL 2020 K15	125	38	20	25	20	DN-- 1506	TC044 M6	TA014-1	TC038 M4x10	BK020	BY040	BSP030	4 Allen
D296	●	DDHNL 2525 M15	150	38	25	32	25								
D297	●	DDHNL 3232 P15	170	38	32	40	32								

● Stokta / In Stock / Lager ○ Sınırlı Stok / Limited Stock / Begrenzte Lagerhaltung

## 93° DDJNR

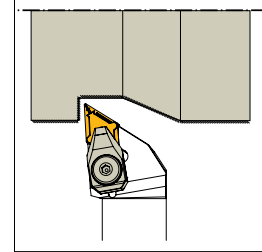
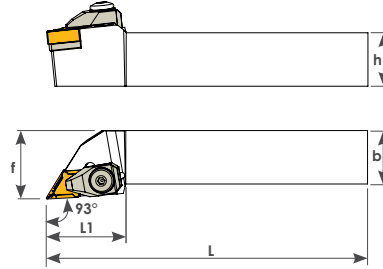

Sipariş Kodu Order Code Best.-Nr.	Stok/Stock/Lager	Ürün Kodu Product Code Produkt-Code	Ölçüler (mm) Dimensions(mm) Abmessungen (mm)					Kullanılan Uç Insert WSP	Baskı Civatası Locking Screw Verriegelungs Schraube	Afllık Shim U-Platte	Afllık Civatası Shim Screw U-Platte Schraube	Baskı Kepi Clamp Spann pratze	Yay Spring Feder	Pul Washer U-Scheibe	Anahtar Allen Key Inbuss- Schlüssel
			L	L1	h	f	b								
D171	●	DDJNR 2020 K15	125	38	20	25	20	DN--1504	TC044 M6	TA014- 1	TC038 M4x10	BK020	BY040	BSP030	4 Allen
D169	●	DDJNR 2525 M15	150	38	25	32	25								

## 93° DDJNL

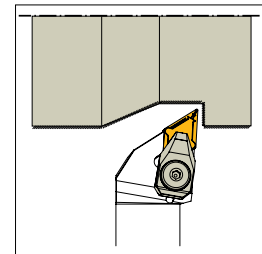
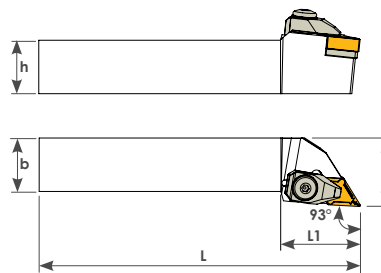

Sipariş Kodu Order Code Best.-Nr.	Stok/Stock/Lager	Ürün Kodu Product Code Produkt-Code	Ölçüler (mm) Dimensions(mm) Abmessungen (mm)					Kullanılan Uç Insert WSP	Baskı Civatası Locking Screw Verriegelungs Schraube	Afllık Shim U-Platte	Afllık Civatası Shim Screw U-Platte Schraube	Baskı Kepi Clamp Spann pratze	Yay Spring Feder	Pul Washer U-Scheibe	Anahtar Allen Key Inbuss- Schlüssel
			L	L1	h	f	b								
D313	●	DDJNL 2020 K15	125	38	20	25	20	DN-- 1504	TC044 M6	TA014- 1	TC038 M4x10	BK020	BY040	BSP030	4 Allen
D309	●	DDJNL 2525 M15	150	38	25	32	25								

● Stokta/ In Stock / Lager ○ Sınırlı Stok / Limited Stock / Begrenzte Lagerhaltung

## 95° DWLNR

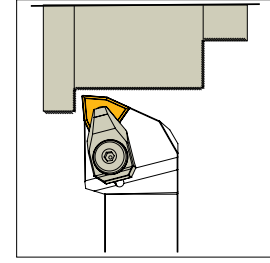
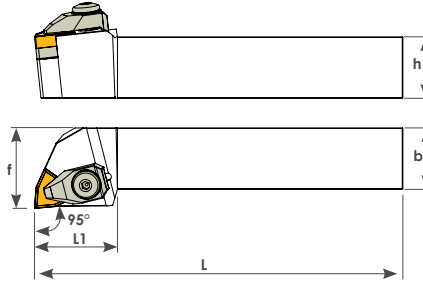

Sipariş Kodu Order Code Best.-Nr.	Stok/Stock/Lager	Ürün Kodu Product Code Produkt-Code	Ölçüler (mm) Dimensions(mm) Abmessungen (mm)					Kullanılan Uç Insert WSP	Baskı Cıvatası Locking Screw Verriegelungs Schraube	Altlık Shim U-Platte	Altlık Cıvatası Shim Screw U-Platte Schraube	Baskı Kepi Clamp Spann pratze	Yay Spring Feder	Pul Washer U- Scheibe	Anahtar Allen Key Inbuss- Schlüssel
			L	L1	h	f	b								
D181	●	DWLNR 1616 H06	100	28	16	20	16	WN-- 0604	TC046 M5	TA021	TC065 M3x7	BK024	BY041	BSP031	3 Allen
D177	●	DWLNR 2020 K06	125	30	20	25	20								
D179	●	DWLNR 2525 M06	150	30	25	32	25								
D176	●	DWLNR 2020 K08	125	35	20	25	20	WN-- 0804	TC044 M6	TA020-1	TC083 M5x12	BK020	BY040	BSP030	4 Allen
D178	●	DWLNR 2525 M08	150	35	25	32	25								
D180	●	DWLNR 3232 P08	170	35	32	40	32								

## 95° DWLNL

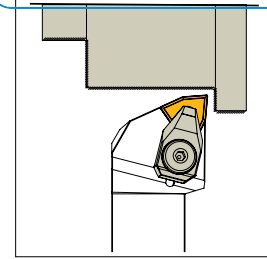
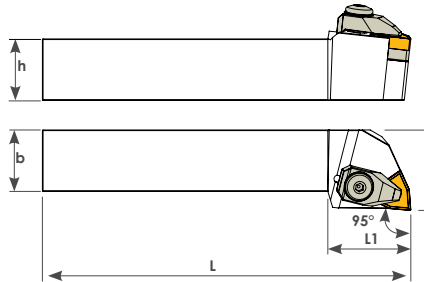

Sipariş Kodu Order Code Best.-Nr.	Stok/Stock/Lager	Ürün Kodu Product Code Produkt-Code	Ölçüler (mm) Dimensions(mm) Abmessungen (mm)					Kullanılan Uç Insert WSP	Baskı Cıvatası Locking Screw Verriegelungs Schraube	Altlık Shim U-Platte	Altlık Cıvatası Shim Screw U-Platte Schraube	Baskı Kepi Clamp Spann pratze	Yay Spring Feder	Pul Washer U- Scheibe	Anahtar Allen Key Inbuss- Schlüssel
			L	L1	h	f	b								
D328	●	DWLNL 1616 H06	100	28	16	20	16	WN-- 0604	TC046 M5	TA021	TC065 M3x7	BK024	BY041	BSP031	3 Allen
D329	●	DWLNL 2020 K06	125	30	20	25	20								
D319	●	DWLNL 2525 M06	150	30	25	32	25								
D316	●	DWLNL 2020 K08	125	35	20	25	20	WN-- 0804	TC044 M6	TA020-1	TC083 M5x12	BK020	BY040	BSP030	4 Allen
D318	●	DWLNL 2525 M08	150	37	25	32	25								
D320	●	DWLNL 3232 P08	170	35	32	40	32								

● Stokta/ In Stock / Lager ○ Sınırlı Stok / Limited Stock / Begrenzte Lagerhaltung

## 95° MWLNR

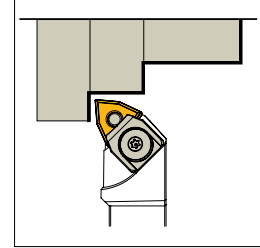
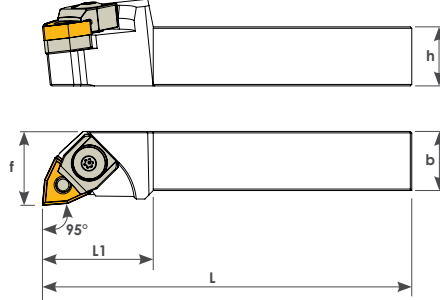

Sipariş Kodu Order Code Best.-Nr.	Stok/Stock/Lager	Ürün Kodu Product Code Produkt-Code	Ölçüler (mm) Dimensions (mm) Abmessungen (mm)					Kullanılan Uç Insert WSP	Baskı Civatası Locking Screw Verriegelungs Schraube	Altlık Shim U-Platte	Altlık Pimi Lock Pin Rohrstift	Baskı Kepi Clamp Spann pratze	Yay Spring Feder	Pul Washer U-Scheibe	Anahtar Allen Key Inbus- Schlüssel
			L	L1	h	f	b								
D182	●	MWLNR 2020 K08	125	32	20	25	20	WN --0804	TC044 M6	TA020	BSP021	BK026	BY040	BSP030	4 Allen
D184	●	MWLNR 2525 M08	150	32	25	32	25								
D185	●	MWLNR 3232 P08	170	32	32	40	32								

## 95° MWLNL

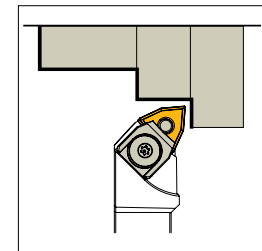
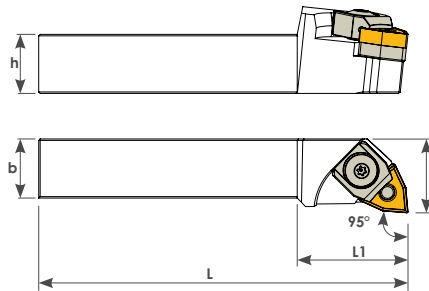

Sipariş Kodu Order Code Best.-Nr.	Stok/Stock/Lager	Ürün Kodu Product Code Produkt-Code	Ölçüler (mm) Dimensions (mm) Abmessungen (mm)					Kullanılan Uç Insert WSP	Baskı Civatası Locking Screw Verriegelungs Schraube	Altlık Shim U-Platte	Altlık Pimi Lock Pin Rohrstift	Baskı Kepi Clamp Spann pratze	Yay Spring Feder	Pul Washer U-Scheibe	Anahtar Allen Key Inbus- Schlüssel
			L	L1	h	f	b								
D322	●	MWLNL 2020 K08	125	32	20	25	20	WN --0804	TC044 M6	TA020	BSP021	BK026	BY040	BSP030	4 Allen
D324	●	MWLNL 2525 M08	150	32	25	32	25								
D326	●	MWLNL 3232 P08	170	32	32	40	32								

● Stokta/ In Stock / Lager ○ Sınırlı Stok / Limited Stock / Begrenzte Lagerhaltung

## 95° MWMNN

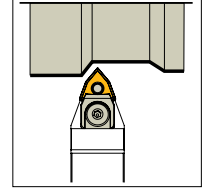
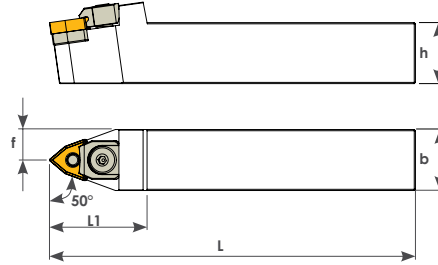

Sipariş Kodu Order Code Best.-Nr.	Stok/Stock/Lager	Ürün Kodu Product Code Produkt-Code	Ölçüler (mm) Dimensions (mm) Abmessungen (mm)					Kullanılan Uç Insert WSP	Baskı Civatası Locking Screw Verriegelungs Schraube	Aflık Shim U-Platte	Aflık Pimi Lock Pin Rohrstift	Baskı Kepi Clamp Spann pratze	Yay Spring Feder	Pul Washer U-Scheibe	Anahtar Allen Key Inbuss- Schlüssel
			L	L1	h	f	b								
D114	●	MWMNN 2020 K08	125	40	20	10	20	WN --0804	TC044 M6	TA020	BSP021	BK026	BY040	BSP030	4 Allen
D116	●	MWMNN 2525 M08	150	40	25	12.5	25								

● Stokta / In Stock / Lager ○ Sınırlı Stok / Limited Stock / Begrenzte Lagerhaltung

**تکنیک تولز**  
ایران آلات صنعتی، تراشکاری و ماشینکاری  
۶۶۷۱۱۶۷ - ۶۶۷۱۱۷۲۹

تهران، ج امام خمینی، م حسن آباد، پاساژ هشت گنبد، شماره ۱۵



## 93° MTJNR

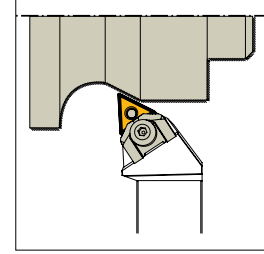
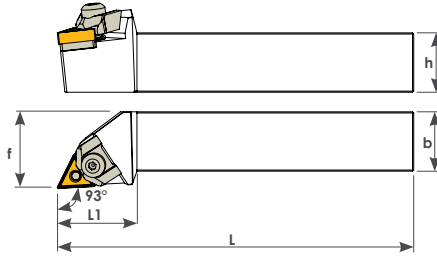

Sipariş Kodu Order Code Best.-Nr.	Stok/Stock/Lager	Ürün Kodu Product Code Produkt-Code	Ölçüler (mm) Dimensions (mm) Abmessungen (mm)					Kullanılan Uç Insert WSP	Baskı Cıvatası Locking Screw Verriegelungs Schraube	Altlık Shim U-Platte	Altlık Pimi Lock Pin Rohrstift	Baskı Kepi Clamp Spann- pratze	Yay Spring Feder	Pul Washer U-Scheibe	Anahtar Allen Key Inbuss- Schlüssel
			L	L1	h	f	b								
D194	●	MTJNR 2020 K16	125	35	20	25	20	TN --1604	TC046 M5	TA019	BSP020	BK022	BY043	BSP031	3 Allen
D196	●	MTJNR 2525 M16	150	35	25	32	25								
D198	●	MTJNR 3232 P16	170	35	32	40	32								
D200	●	MTJNR 2020 K22	125	37	20	25	20	TN --2204	TC044 M6	TA045	BSP021	BK023	BY040	BSP030	4 Allen
D202	●	MTJNR 2525 M22	150	40	25	32	25								
D204	●	MTJNR 3232 P22	170	40	32	40	32								

## 93° MTJNL



تکنیک تولز  
ابزار آلات صنعتی، تراشکاری و قالبسازی  
۶۶۷۱۱۷۲۹ - ۶۶۷۱۱۹۶۷  
تهران، خ امام خمینی، م حسن آباد، پاساژ هشت گنبد، شماره ۱۵

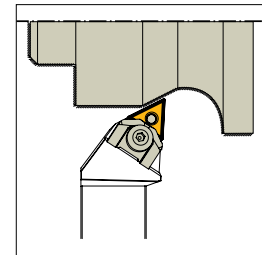
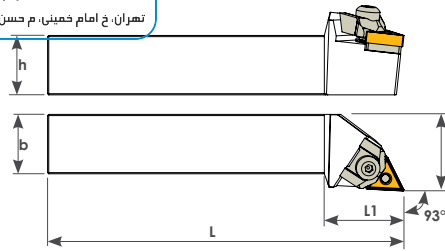

Sipariş Kodu Order Code Best.-Nr.	Stok/Stock/Lager	Ürün Kodu Product Code Produkt-Code	Ölçüler (mm) Dimensions (mm) Abmessungen (mm)					Kullanılan Uç Insert WSP	Baskı Cıvatası Locking Screw Verriegelungs Schraube	Altlık Shim U-Platte	Altlık Pimi Lock Pin Rohrstift	Baskı Kepi Clamp Spann- pratze	Yay Spring Feder	Pul Washer U-Scheibe	Anahtar Allen Key Inbuss- Schlüssel
			L	L1	h	f	b								
D332	●	MTJNL 2020 K16	125	35	20	25	20	TN --1604	TC046 M5	TA019	BSP020	BK022	BY043	BSP031	3 Allen
D334	●	MTJNL 2525 M16	150	35	25	32	25								
D336	●	MTJNL 3232 P16	170	35	32	40	32								
D338	●	MTJNL 2020 K22	125	37	20	25	20	TN --2204	TC044 M6	TA045	BSP021	BK023	BY040	BSP030	4 Allen
D340	●	MTJNL 2525 M22	150	40	25	32	25								
D342	●	MTJNL 3232 P22	170	40	32	40	32								

● Stokta/ In Stock / Lager ○ Sınırlı Stok / Limited Stock / Begrenzte Lagerhaltung



## 60° MTENN

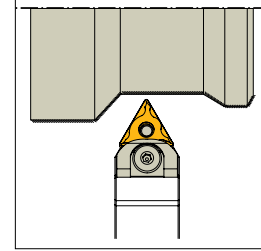
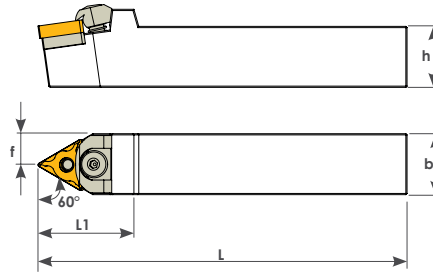

Sipariş Kodu Order Code Best.-Nr.	Stok/Stock/Lager	Ürün Kodu Product Code Produkt-Code	Ölçüler (mm) Dimensions (mm) Abmessungen (mm)					Kullanılan Uç Insert WSP	Baskı Cıvatası Locking Screw Verriegelungs Schraube	Altlık Shim U-Platte	Altlık Pimi Lock Pin Rohrstift	Baskı Kepi Clamp Spann pratze	Yay Spring Feder	Pul Washer U-Scheibe	Anahtar Allen Key Inbuss- Schlüssel
			L	L1	h	f	b								
D108	●	MTENN 2020 K16	125	35	20	10	20	TN-- 1604	TC046 M5	TA019	BSP020	BK022	BY043	BSP031	3 Allen
D110	●	MTENN 2525 M16	150	35	25	12.5	25	TN-- 1604	TC046 M5	TA019	BSP020	BK022	BY043	BSP031	3 Allen
D112	●	MTENN 2525 M22	150	37	25	12.5	25	TN-- 2204	TC044 M6	TA045	BSP021	BK023	BY040	BSP030	4 Allen
D113	●	MTENN 3232 P22	170	41	32	16	32	TN-- 2204	TC044 M6	TA045	BSP021	BK023	BY040	BSP030	4 Allen

● Stokta / In Stock / Lager ○ Sınırlı Stok / Limited Stock / Begrenzte Lagerhaltung



## 93° DVJNR

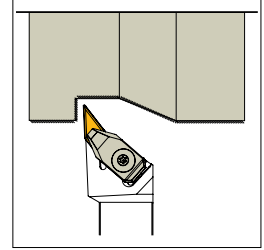
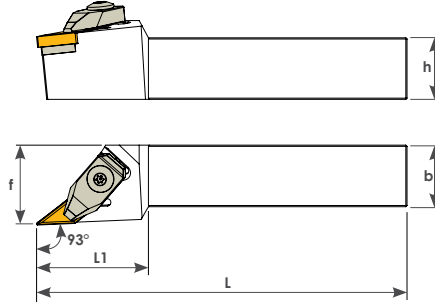

Sipariş Kodu Order Code Best.-Nr.	Stok/Stock/Lager	Ürün Kodu Product Code Produkt-Code	Ölçüler (mm) Dimensions (mm) Abmessungen (mm)					Kullanılan Uç Insert WSP	Baskı Civatası Locking Screw Verriegelungs Schraube	Altılık Shim U-Platte	Altılık Civatası Shim Screw U-Platte Schraube	Baskı Kepi Clamp Spannpratze	Yay Spring Feder	Pul Washer U-Scheibe	Anahtar Allen Key Inbusschlüssel
			L	L1	h	f	b								
D105-1	●	DVJNR 2020 K16	125	42	20	25	20	VN-- 1604	TC046 M5	TA032	TC075 M4x11-50	BK021	BY043	BSP031	3 Allen
D105	●	DVJNR 2525 M16	150	42	25	32	25								

● Stokta / In Stock / Lager ○ Sınırlı Stok / Limited Stock / Begrenzte Lagerhaltung



## 93° DVJNL

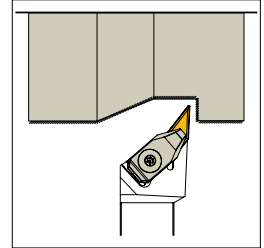
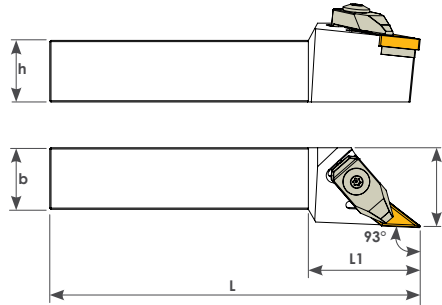

Sipariş Kodu Order Code Best.-Nr.	Stok/Stock/Lager	Ürün Kodu Product Code Produkt-Code	Ölçüler (mm) Dimensions (mm) Abmessungen (mm)					Kullanılan Uç Insert WSP	Baskı Civatası Locking Screw Verriegelungs Schraube	Altılık Shim U-Platte	Altılık Civatası Shim Screw U-Platte Schraube	Baskı Kepi Clamp Spannpratze	Yay Spring Feder	Pul Washer U-Scheibe	Anahtar Allen Key Inbusschlüssel
			L	L1	h	f	b								
D343	●	DVJNL 2020 K16	125	42	20	25	20	VN-- 1604	TC046 M5	TA032	TC075 M4x11-50	BK021	BY043	BSP031	3 Allen
D344	●	DVJNL 2525 M16	150	42	25	32	25								

● Stokta / In Stock / Lager ○ Sınırlı Stok / Limited Stock / Begrenzte Lagerhaltung

## 72,5° DVVNN

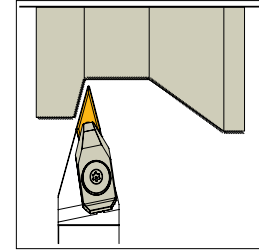
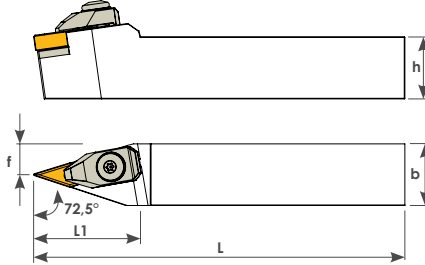

Sipariş Kodu Order Code Best.-Nr.	Stok/Stock/Lager	Ürün Kodu Product Code Produkt-Code	Ölçüler (mm) Dimensions (mm) Abmessungen (mm)					Kullanılan Uç Insert WSP	Baskı Civatası Locking Screw Verriegelungs Schraube	Altlık Shim U-Platte	Altlık Civatası Shim Screw U-Platte Schraube	Baskı Kepli Clamp Spann pratze	Yay Spring Feder	Pul Washer U-Scheibe	Anahtar Allen Key Inbuss- Schlüssel
			L	L1	h	f	b								
D105-2	●	DVVNN 2525 M16	150	42	25	12,5	25								
								VN-- 1604	TC046 M5	TA032	TC075 M4x11-50	BK021	BY043	BSP031	3 Allen

● Stokta / In Stock / Lager ○ Sınırlı Stok / Limited Stock / Begrenzte Lagerhaltung

**تکنیک تولز**  
ابزار آلات صنعتی، تراشکاری و فالپساری  
۶۶۷۱۱۹۶۷ - ۶۶۷۱۱۷۴۹  
تهران، ج امام خمینی، م حسن آباد، پاساژ هشت کتبی، شماره ۱۵

## 93° CKJNR

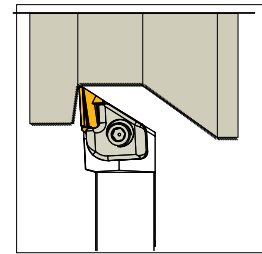
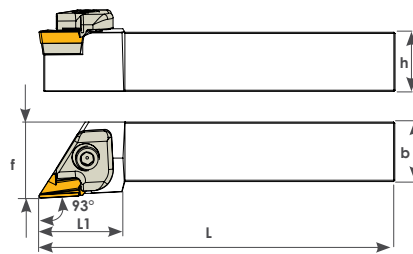

Sipariş Kodu Order Code Best.-Nr.	Stok/Stock/Lager	Ürün Kodu Product Code Produkt-Code	Ölçüler (mm) Dimensions (mm) Abmessungen (mm)					Kullanılan Uç Insert WSP	Baskı Civatası Locking Screw Verriegelungs Schraube	Altlık Shim U-Platte	Altlık Civatası Shim Screw U-Platte Schraube	Baskı Kepli Clamp Spann pratze	Yay Spring Feder	Pul Washer U-Scheibe	Anahtar Allen Key Inbuss- Schlüssel
			L	L1	h	f	b								
RD018	●	CKJNR 2020 K16	125	32	20	26,5	20								
RD014	●	CKJNR 2525 M16	150	35	25	30	25	KNUX 1604	TC044 M6	TA046	TC036 M3x10	BK028	BY042	BSP030	4 Allen
RD013	●	CKJNR 3232 P16	170	35	32	40	32								

● Stokta / In Stock / Lager ○ Sınırlı Stok / Limited Stock / Begrenzte Lagerhaltung

## 95° DCLNR

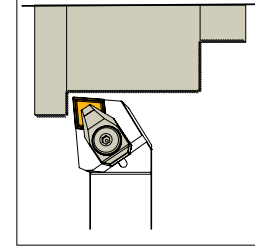
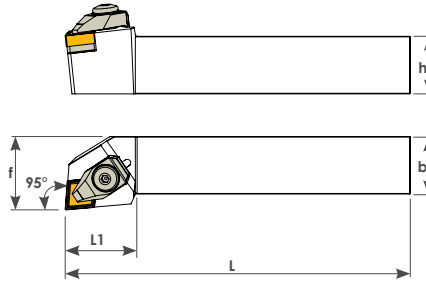

Sipariş Kodu Order Code Best.-Nr.	Stok/Stock/Lager	Ürün Kodu Product Code Produkt-Code	Ölçüler (mm) Dimensions(mm) Abmessungen (mm)					Kullanılan Uç Insert WSP	Aitlik Shim U-Platte	Aitlik Civatası Shim Screw U-Platte Schraube	Baskı Kepi Clamp Spann pratze	Baskı Civatası Locking Screw Verriegelungs Schraube	Yay Spring Feder	Pul Washer U-Scheibe	Anahtar Allen Key Inbuss-Schlüssel
			L	L1	h	f	b								
D160	●	DCLNR 2020 K12	125	30	20	25	20	CN-- 1204	TA016-1	TC038 M4x10	BK020	TC044 M6	BY040	BSP030	4 Allen
D162	●	DCLNR 2525 M12	150	32	25	32	25								
D164	●	DCLNR 3232 P12	170	32	32	40	32	CN-- 1606	TA022	TC095 M5x11,8	BK018	TC044 M6	BY040	BSP030	4 Allen
D162-1	●	DCLNR 2525 M16	150	37	25	32	25								
D165	●	DCLNR 3232 P16	170	38	32	40	32	CN-- 1906	TA017	TC039 M6x12	BK018	TC044 M6	BY040	BSP030	4 Allen
D163	●	DCLNR 2525 M19	150	38	25	32	25								
D166	●	DCLNR 3232 P19	170	38	32	40	32	CN-- 1906	TA017	TC039 M6x12	BK018	TC044 M6	BY040	BSP030	4 Allen
D166-1	●	DCLNR 4040 S19	250	43	40	40	40								

## 95° DCLNL

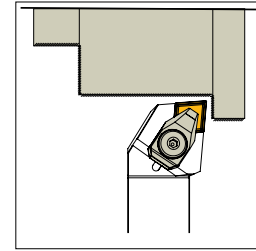
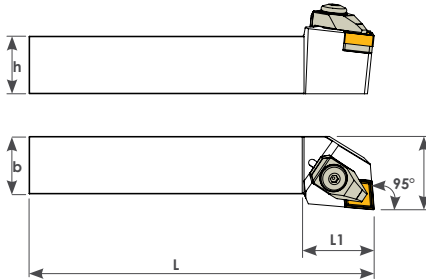

Sipariş Kodu Order Code Best.-Nr.	Stok/Stock/Lager	Ürün Kodu Product Code Produkt-Code	Ölçüler (mm) Dimensions(mm) Abmessungen (mm)					Kullanılan Uç Insert WSP	Aitlik Shim U-Platte	Aitlik Civatası Shim Screw U-Platte Schraube	Baskı Kepi Clamp Spann pratze	Baskı Civatası Locking Screw Verriegelungs Schraube	Yay Spring Feder	Pul Washer U-Scheibe	Anahtar Allen Key Inbuss-Schlüssel
			L	L1	h	f	b								
D301	●	DCLNL 2020 K12	125	30	20	25	20	CN-- 1204	TA016-1	TC038 M4x10	BK020	TC044 M6	BY040	BSP030	4 Allen
D302	●	DCLNL 2525 M12	150	32	25	32	25								
D305	●	DCLNL 3232 P12	170	32	32	40	32	CN-- 1606	TA022	TC095 M5x11,8	BK018	TC044 M6	BY040	BSP030	4 Allen
D303	●	DCLNL 2525 M16	150	37	25	32	25								
D306	●	DCLNL 3232 P16	170	38	32	40	32	CN-- 1906	TA017	TC039 M6x12	BK018	TC044 M6	BY040	BSP030	4 Allen
D304	●	DCLNL 2525 M19	150	38	25	32	25								
D307	●	DCLNL 3232 P19	170	38	32	40	32	CN-- 1906	TA017	TC039 M6x12	BK018	TC044 M6	BY040	BSP030	4 Allen
D307-2	●	DCLNL 4040 S19	250	43	40	40	40								

● Stokta / In Stock / Lager ○ Sınırlı Stok / Limited Stock / Begrenzte Lagerhaltung

**D Sistem Dış Çap Kater**  
D System External Turning Holders  
D System Klemmhalter

Technical solution for quality

تکنیک تولز

ابزار آلات صنعتی، تراشکاری و قالبسازی  
۶۶۷۱۱۶۷ - ۶۶۷۱۱۶۹  
تهران، خ امام خمینی، م حسن آباد، پاساژ هشت گنبد، شماره ۱۵

Kalite için TEKNİK çözüm

**50° DCMNN**

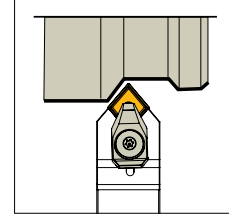
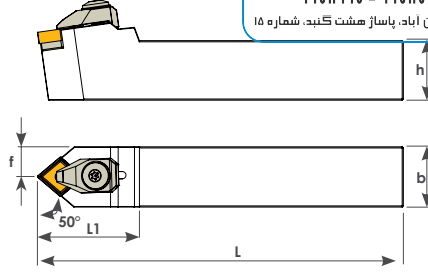

Sipariş Kodu Order Code Best.-Nr.	Stok/Stock/Lager	Ürün Kodu Product Code Produkt-Code	Ölçüler (mm) Dimensions (mm) Abmessungen (mm)					Kullanılan Uç Insert WSP	Baskı Cıvatası Locking Screw Verriegelungs Schraube	Altlık Shim U-Platte	Altlık Cıvatası Shim Screw U-Platte Schraube	Baskı Kepi Clamp Spannpratze	Yay Spring Feder	Pul Washer U-Scheibe	Anahtar Allen Key Inbuss-Schlüssel
			L	L1	h	f	b								
D214-1	●	DCMNN 2020 K12	125	35	20	10	20	CN-- 1204	TC044 M6	TA016	TC038 M4x10	BK020	BY040	BSP030	4 Allen
D215	●	DCMNN 2525 M12	150	42	25	12,5	25								

**45° DCSNR**

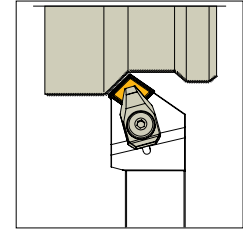
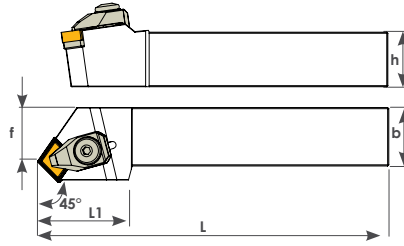

D218	●	DCSNR 2525 M12	150	42	25	12,5	25	CN-- 1204	TC044 M6	TA016	TC038 M4x10	BK020	BY040	BSP030	4 Allen

**40° DCXNN**

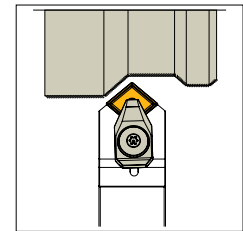
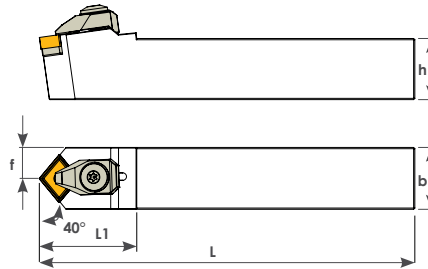

Sipariş Kodu Order Code Best.-Nr.	Stok/Stock/Lager	Ürün Kodu Product Code Produkt-Code	Ölçüler (mm) Dimensions (mm) Abmessungen (mm)					Kullanılan Uç Insert WSP	Baskı Cıvatası Locking Screw Verriegelungs Schraube	Altlık Shim U-Platte	Altlık Cıvatası Shim Screw U-Platte Schraube	Baskı Kepi Clamp Spannpratze	Yay Spring Feder	Pul Washer U-Scheibe	Anahtar Allen Key Inbuss-Schlüssel
			L	L1	h	f	b								
D216	●	DCXNN 2525 M12	150	40	25	12,5	25	CN-- 1204	TC044 M6	TA016	TC038 M4x10	BK020	BY040	BSP030	4 Allen

● Stokta / In Stock / Lager ○ Sınırlı Stok / Limited Stock / Begrenzte Lagerhaltung

## 45° DSSNR

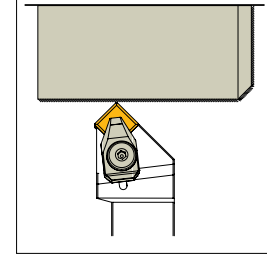
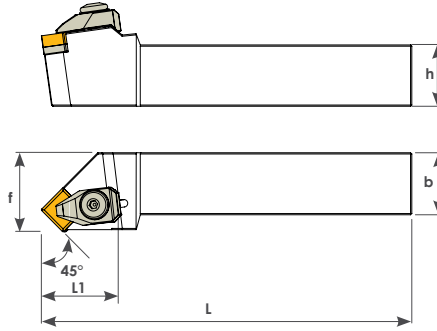

Sipariş Kodu Order Code Best.-Nr.	Stok/Stock/Lager	Ürün Kodu Product Code Produkt-Code	Ölçüler (mm) Dimensions (mm) Abmessungen (mm)					Kullanılan Uç Insert WSP	Baskı Civatası Locking Screw Verriegelungs Schraube	Altılık Shim U-Platte	Altılık Civatası Shim Screw U-Platte Schraube	Baskı Keps Clamp Spann pratze	Yay Spring Feder	Pul Washer U-Scheibe	Anahtar Allen Key Inbuss-Schlüssel
			L	L1	h	f	b								
D210	●	DSSNR 2020 K12	125	40	20	25	20								
D212	●	DSSNR 2525 M12	150	40	25	32	25	SNMG 1204	TC044 M6	TA050	TC038 M4x10	BK020	BY040	BSP030	4 Allen



## 75° DCKNR

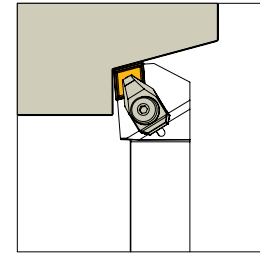
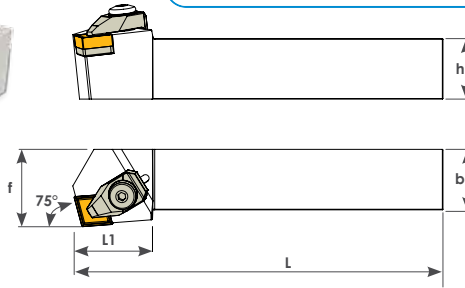

Sipariş Kodu Order Code Best.-Nr.	Stok/Stock/Lager	Ürün Kodu Product Code Produkt-Code	Ölçüler (mm) Dimensions (mm) Abmessungen (mm)					Kullanılan Uç Insert WSP	Altılık Shim U-Platte	Altılık Civatası Shim Screw U-Platte Schraube	Baskı Keps Clamp Spann pratze	Baskı Civatası Locking Screw Verriegelungs Schraube	Yay Spring Feder	Pul Washer U-Scheibe	Anahtar Allen Key Inbuss-Schlüssel
			L	L1	h	f	b								
D116-1	●	DCKNR 2525 M12	150	34	25	32	25	CNMG 1204	TA016	TC038 M4x10	BK020				
D162-3	●	DCKNR 2525 M16	125	37	25	32	25	CNMG 1606	TA022	TC095 M5x11,8	BK018	TC044 M6	BY040	BSP030	4 Allen

● Stokta/ In Stock / Lager ○ Sınırlı Stok / Limited Stock / Begrenzte Lagerhaltung

## 93° DDUNR

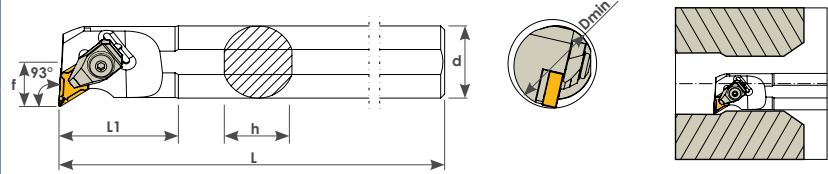

Sipariş Kodu Order Code Best.-Nr.	Stok/Stock/Lager	Ürün Kodu Product Code Produkt-Code	Ölçüler (mm) Dimensions (mm) Abmessungen (mm)						Kullanılan Uç Insert WSP	Baskı Cıvatası Locking Screw Verriegelungs Schraube	Aflık Shim U-Platte	Aflık Cıvatası Shim Screw U-Platte Schraube	Baskı Kepi Clamp Spann pratze	Yay Spring Feder	Pul Washer U-Scheibe	Anahtar Allen Key Inbuss-Schlüssel
			Dmin	d	L	L1	f	h								
K409	●	S25S DDUNR 11	32	25	250	50	17	23	DN --1506	TC044 M6	TA014	TC038 M4x10	BK020	BY040	BSP030	4 Allen
K410	●	S25S DDUNR 15	32	25	250	50	17	23								
K412	●	S32T DDUNR 15	40	32	300	55	22	30								
K414	●	S40T DDUNR 15	50	40	300	55	27	38								
K415	●	S40U DDUNR 15	50	40	350	55	27	38								
K416	●	S50U DDUNR 15	63	50	350	65	35	47								
K417	●	S50X DDUNR 15	63	50	550	65	35	47								
K417-1	●	S60X DDUNR 15	80	60	600	65	40	57								
K411	●	S25S DDUNR 15	32	25	250	50	17	23	DN--1504							
K413	●	S32T DDUNR 15	40	32	300	55	22	30								

## 93° DDUNL

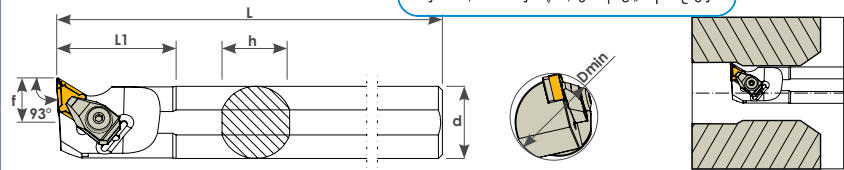

**تکنیک تولز**  
ابزار آلات صنعتی، تراشکاری و ماشینکاری  
۶۶۷۱۱۹۶۷ - ۶۶۷۱۱۷۲۹  
تهران، خ امام خمینی، م حسن آباد، پاساژ هشت گنبد، شماره ۱۵

Sipariş Kodu Order Code Best.-Nr.	Stok/Stock/Lager	Ürün Kodu Product Code Produkt-Code	Ölçüler (mm) Dimensions (mm) Abmessungen (mm)						Kullanılan Uç Insert WSP	Baskı Cıvatası Locking Screw Verriegelungs Schraube	Aflık Shim U-Platte	Aflık Cıvatası Shim Screw U-Platte Schraube	Baskı Kepi Clamp Spann pratze	Yay Spring Feder	Pul Washer U-Scheibe	Anahtar Allen Key Inbuss-Schlüssel
			Dmin	d	L	L1	f	h								
K487	●	S20R DDUNL 11	30	20	200	50	13	18	DN --1104	TC046 M5	TA030	TC075 M4x11	BK024	BY041	BSP031	3 Allen
K488	●	S25S DDUNL 11	32	25	250	50	17	23								
K490	●	S25S DDUNL 15	32	25	250	50	17	23	DN --1506	TC044 M6	TA014	TC038 M4x10	BK020	BY040	BSP030	4 Allen
K492	●	S32T DDUNL 15	40	32	300	55	22	30								
K494	●	S40T DDUNL 15	50	40	300	55	27	38								
K496	●	S50U DDUNL 15	63	50	350	65	35	47								

● Stokta / In Stock / Lager ○ Sınırlı Stok / Limited Stock / Begrenzte Lagerhaltung

## 93° MDUNR

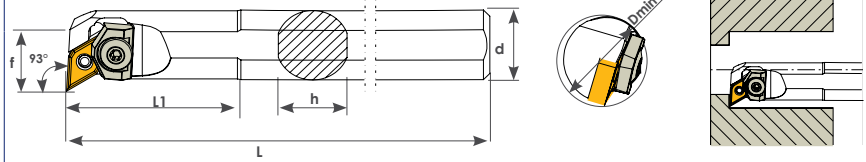

Sipariş Kodu Order Code Best.-Nr.	Stok/Stok/Lager	Ürün Kodu Product Code Produkt-Code	Ölçüler (mm) Dimensions (mm) Abmessungen (mm)							Kullanılan Uç Insert WSP	Baskı Civatası Locking Screw Verriegelungs Schraube	Altlık Pimi Lock Pin Rohrstift	Baskı Kepi Clamp Spannpratze	Anahtar Allen Key Inbuss-Schlüssel
			Dmin	d	L	L1	f	h	kg					
K408-1	●	S20R MDUNR 11	25	20	200	50	13	18		DN --1104	TC046 M5	BSP021	BK017	3 Allen

● Stokta / In Stock / Lager ○ Sınırlı Stok / Limited Stock / Begrenzte Lagerhaltung

## 62,5° DDWNR

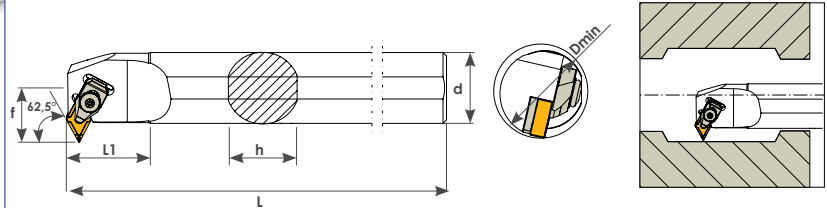

Sipariş Kodu Order Code Best.-Nr.	Stok/Stok/Lager	Ürün Kodu Product Code Produkt-Code	Ölçüler (mm) Dimensions (mm) Abmessungen (mm)							Kullanılan Uç Insert WSP	Baskı Civatası Locking Screw Verriegelungs Schraube	Altlık Shim U-Platte	Altlık Civatası Shim Screw U-Platte Schraube	Baskı Kepi Clamp Spann pratze	Yay Spring Feder	Pul Washer U-Scheibe	Anahtar Allen Key Inbuss-Schlüssel
			Dmin	d	L	L1	f	h	kg								
K464	●	S32T DDWNR 15	40	32	300	50	24	30									
K466	●	S40T DDWNR 15	50	40	300	50	30	38	DN --1506	TC044 M6	TA014	TC038 M4x10	BK020	BY040	BSP030	4 Allen	
K468	●	S50U DDWNR 15	63	50	350	60	35	47									

● Stokta / In Stock / Lager ○ Sınırlı Stok / Limited Stock / Begrenzte Lagerhaltung



## 107,5° DDQNR

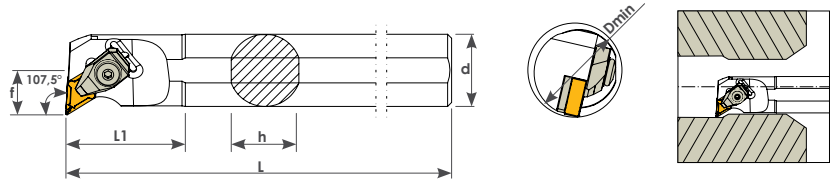

Sipariş Kodu Order Code Best.-Nr.	Stok/Stock/Lager	Ürün Kodu Product Code Produkt-Code	Ölçüler (mm) Dimensions(mm) Abmessungen (mm)						Kullanılan Uç Insert WSP	Baskı Civatası Locking Screw Verriegelungs Schraube	Altlık Shim U-Platte	Altlık Civatası Shim Screw U-Platte Schraube	Baskı Kepli Clamp Spann pratze	Yay Spring Feder	Pul Washer U-Scheibe	Anahtar Allen Key Inbuss-Schlüssel
			Dmin	d	L	L1	f	h								
K476	●	S25S DDQNR 15	32	25	250	50	17	23	DN-- 1506	TC044 M6	TA014	TC038 M4x10	BK020	BY040	BSP030	4 Allen
K477	●	S32T DDQNR 15	40	32	300	55	22	30								
K478	●	S40T DDQNR 15	50	40	300	55	27	38								
K479	●	S50U DDQNR 15	63	50	350	65	35	47								

## 107,5° DDQNL

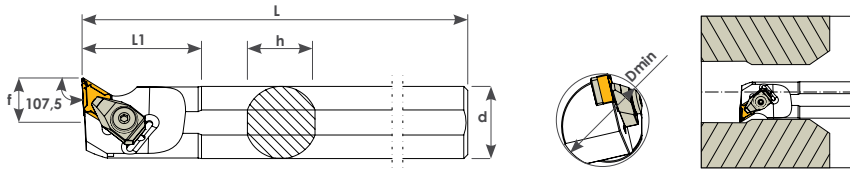

Sipariş Kodu Order Code Best.-Nr.	Stok/Stock/Lager	Ürün Kodu Product Code Produkt-Code	Ölçüler (mm) Dimensions(mm) Abmessungen (mm)						Kullanılan Uç Insert WSP	Baskı Civatası Locking Screw Verriegelungs Schraube	Altlık Shim U-Platte	Altlık Civatası Shim Screw U-Platte Schraube	Baskı Kepli Clamp Spann pratze	Yay Spring Feder	Pul Washer U-Scheibe	Anahtar Allen Key Inbuss-Schlüssel
			Dmin	d	L	L1	f	h								
K533	●	S25S DDQNL 15	32	25	250	50	17	23	DN --1506	TC044 M6	TA014	TC038 M4x10	BK020	BY040	BSP030	4 Allen
K534	●	S32T DDQNL 15	40	32	300	55	22	30								
K535	●	S40T DDQNL 15	50	40	300	55	27	38								
K536	●	S50U DDQNL 15	63	50	350	65	35	47								

● Stokta / In Stock / Lager ○ Sınırlı Stok / Limited Stock / Begrenzte Lagerhaltung

## 95° DCLNR

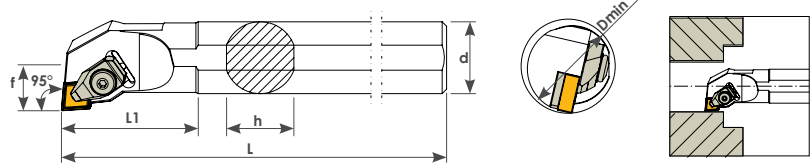

Sipariş Kodu Order Code Best.-Nr.	Stok/Stock/Lager	Ürün Kodu Product Code Produkt-Code	Ölçüler (mm) Dimensions(mm) Abmessungen (mm)						Kullanılan Uç Insert WSP	Baskı Cıvatası Locking Screw Verriegelungs Schraube	Altlık Shim U-Platte	Altlık Cıvatası Shim Screw U-Platte Schraube	Baskı Kepi Clamp Spann pratze	Yay Spring Feder	Pul Washer U-Scheibe	Anahtar Allen Key Inbuss-Schlüssel
			Dmin	d	L	L1	f	h								
K400	●	S25S DCLNR 12	32	25	250	50	17	23	CN --1204	TC044 M6	TA016	TC038 M4x10	BK020	BY040	BSP030	4 Allen
K402	●	S32T DCLNR 12	40	32	300	60	22	30								
K404	●	S40T DCLNR 12	50	40	300	60	27	38								
K406	●	S50U DCLNR 12	63	50	350	75	35	47								

## 95° DCLNL

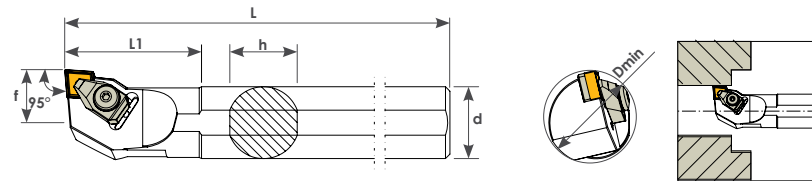







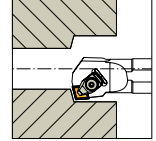
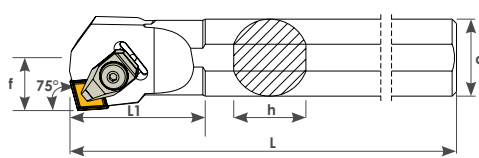

**تکنیک تولز**  
ابزار آلات صنعتی، تراشکاری و قالبسازی  
۶۶۷۱۱۶۶۷ - ۶۶۷۱۱۷۲۹  
تهران، ج امام خمینی، م حسن آباد، پاساژ هشت گنبد، شماره ۱۵

Sipariş Kodu Order Code Best.-Nr.	Stok/Stock/Lager	Ürün Kodu Product Code Produkt-Code	Ölçüler (mm) Dimensions(mm) Abmessungen (mm)						Kullanılan Uç Insert WSP	Baskı Cıvatası Locking Screw Verriegelungs Schraube	Altlık Shim U-Platte	Altlık Cıvatası Shim Screw U-Platte Schraube	Baskı Kepi Clamp Spann pratze	Yay Spring Feder	Pul Washer U-Scheibe	Anahtar Allen Key Inbuss-Schlüssel
			Dmin	d	L	L1	f	h								
K480	●	S25S DCLNL 12	32	25	250	50	17	23	CN --1204	TC044 M6	TA016	TC038 M4x10	BK020	BY040	BSP030	4 Allen
K482	●	S32T DCLNL 12	40	32	300	60	22	30								
K484	●	S40T DCLNL 12	50	40	300	60	27	38								
K486	●	S50U DCLNL 12	63	50	350	75	35	47								

● Stokta/ In Stock / Lager ○ Sınırlı Stok / Limited Stock / Begrenzte Lagerhaltung

## 75° DCKNR



Sipariş Kodu Order Code Best.-Nr.	Stok/Stock/Lager	Ürün Kodu Product Code Produkt-Code	Ölçüler (mm) Dimensions (mm) Abmessungen (mm)						Kullanılan Uç Insert WSP	Baskı Civatası Locking Screw Verriegelungs Schraube	Altlık Shim U-Platte	Altlık Civatası Shim Screw U-Platte Schraube	Baskı Kepi Clamp Spann- pratze	Yay Spring Feder	Pul Washer U-Scheibe	Anahtar Allen Key Inbuss- Schlüssel
			Dmin	d	L	L1	f	h								
K401	●	S25S DCKNR 12	32	25	250	50	17	23	CN --1204	TC044 M6	TA016	TC038 M4x10	BK020	BY040	BSP030	4 Allen
K403	●	S32T DCKNR 12	40	32	300	50	22	30								
K405	●	S40T DCKNR 12	50	40	300	60	27	38								

● Stokta/ In Stock / Lager ○ Sınırlı Stok / Limited Stock / Begrenzte Lagerhaltung

**تکنیک تولز**  
ابزار آلات صنعتی، تراشکاری و ماشینکاری

تهران، خ امام خمینی، م حسن آباد، پاساژ هشت گنبد، شماره ۱۵  
۶۶۷۱۱۶۷ - ۶۶۷۱۱۶۹



## 95° DWLNR

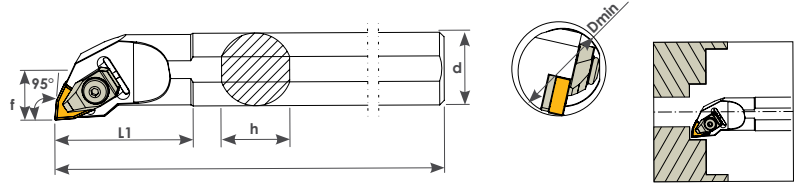

Sipariş Kodu Order Code Best.-Nr.	Stok/Stock/Lager	Ürün Kodu Product Code Produkt-Code	Ölçüler (mm) Dimensions(mm) Abmessungen (mm)						Kullanılan Uç Insert WSP	Baskı Civatası Locking Screw Verriegelungs Schraube	Altlık Shim U-Platte	Altlık Civatası Shim Screw U-Platte Schraube	Baskı Kepi Clamp Spann pratze	Yay Spring Feder	Pul Washer U-Scheibe	Anahtar Allen Key Inbuss- Schlüssel
			Dmin	d	L	L1	f	h								
K418	●	S25S DWLNR 06	32	25	250	50	17	23	WN--0604	TC046 M5	TA021	TC065 M3x7	BK024	BY041	BSP031	3 Allen
K420	●	S25S DWLNR 08	32	25	250	50	17	23	WN--0804	TC044 M6	TA020-1	TC083 M5x7	BK020	BY040	BSP030	4 Allen
K422	●	S32T DWLNR 08	40	32	300	60	22	30								
K424	●	S40T DWLNR 08	50	40	300	60	27	38								
K426	●	S50U DWLNR 08	63	50	350	75	35	47								

## 95° DWLNL

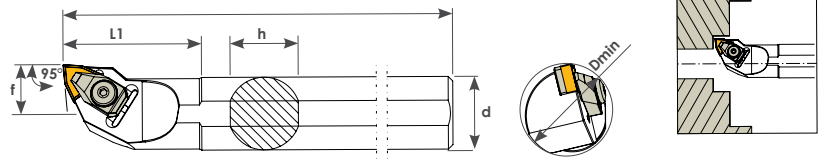

**تکنیک تولز**  
ابزار آلات صنعتی، تراشکاری و ماشینکاری  
۶۶۷۱۱۷۲۹ - ۶۶۷۱۱۹۶۷  
تهران، خ امام خمینی، م حسن آباد، پاساژ هشت گنبد، شماره ۱۵

Sipariş Kodu Order Code Best.-Nr.	Stok/Stock/Lager	Ürün Kodu Product Code Produkt-Code	Ölçüler (mm) Dimensions(mm) Abmessungen (mm)						Kullanılan Uç Insert WSP	Baskı Civatası Locking Screw Verriegelungs Schraube	Altlık Shim U-Platte	Altlık Civatası Shim Screw U-Platte Schraube	Baskı Kepi Clamp Spann pratze	Yay Spring Feder	Pul Washer U-Scheibe	Anahtar Allen Key Inbuss- Schlüssel
			Dmin	d	L	L1	f	h								
K498	●	S25S DWLNL 06	32	25	250	50	17	23	WN--0604	TC046 M5	TA021	TC065 M3x7	BK024	BY041	BSP031	3 Allen
K500	●	S25S DWLNL 08	32	25	250	50	17	23	WN--0804	TC044 M6	TA020-1	TC083 M5x7	BK020	BY040	BSP030	4 Allen
K502	●	S32T DWLNL 08	40	32	300	60	22	30								
K504	●	S40T DWLNL 08	50	40	300	60	27	38								
K506	●	S50U DWLNL 08	63	50	350	75	35	47								

● Stokta / In Stock / Lager ○ Sınırlı Stok / Limited Stock / Begrenzte Lagerhaltung

## 95° MWLNR

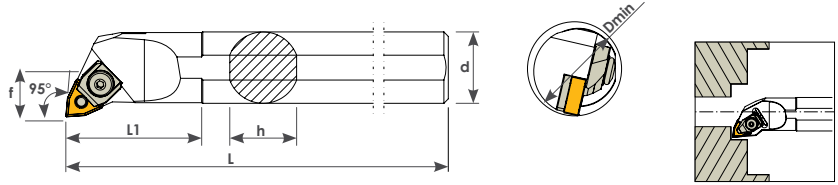

Sipariş Kodu Order Code Best.-Nr.	Stok/Stock/Lager	Ürün Kodu Product Code Produkt-Code	Ölçüler (mm) Dimensions (mm) Abmessungen (mm)						Kullanılan Uç Insert WSP	Baskı Civatası Locking Screw Verriegelungs Schraube	Altlık Shim U-Platte	Altlık Pimi Lock Pin Rohrstift	Baskı Kepi Clamp Spann pratze	Yay Spring Feder	Pul Washer U-Scheibe	Anahtar Allen Key Inbuss-Schlüssel
			Dmin	d	L	L1	f	h								
K427	●	S16Q MWLNR 06	21	16	180	40	11	15	WN--0604	TC046 M5	--	BSP020	BK019	BY041	--	3 Allen
K427-1	●	S20R MWLNR 06	25	20	200	50	13	18								
K428	●	S25S MWLNR 08	32	25	250	45	17	23	WN--0804	TC044 M6	TA020	BSP021	BK026	BY040	BSP030	4 Allen
K430	●	S32T MWLNR 08	40	32	300	60	22	30								
K432	●	S40T MWLNR 08	50	40	300	60	27	38								
K434	●	S50U MWLNR 08	63	50	350	65	35	47								

## 95° MWLNL

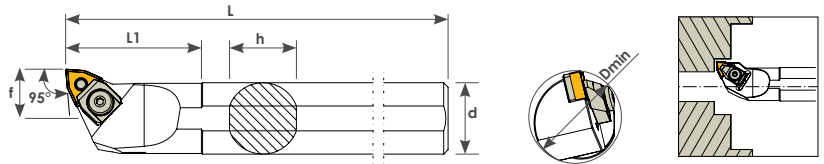

Sipariş Kodu Order Code Best.-Nr.	Stok/Stock/Lager	Ürün Kodu Product Code Produkt-Code	Ölçüler (mm) Dimensions (mm) Abmessungen (mm)						Kullanılan Uç Insert WSP	Baskı Civatası Locking Screw Verriegelungs Schraube	Altlık Shim U-Platte	Altlık Pimi Lock Pin Rohrstift	Baskı Kepi Clamp Spann pratze	Yay Spring Feder	Pul Washer U-Scheibe	Anahtar Allen Key Inbuss-Schlüssel
			Dmin	d	L	L1	f	h								
K510	●	S25S MWLNL 08	32	25	250	45	17	23	WN--0804	TC044 M6	TA020	BSP021	BK026	BY040	BSP030	4 Allen
K512	●	S32T MWLNL 08	40	32	300	60	22	30								
K514	●	S40T MWLNL 08	50	40	300	60	27	38								
K516	●	S50U MWLNL 08	63	50	350	65	35	47								

● Stokta / In Stock / Lager ○ Sınırlı Stok / Limited Stock / Begrenzte Lagerhaltung

## 93° MTUNR

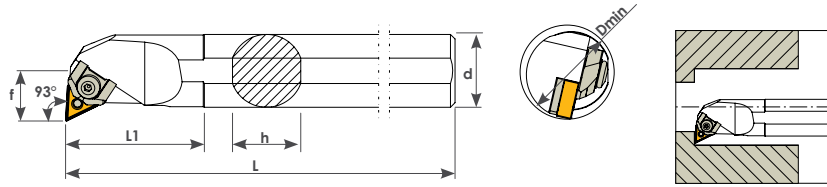

Sipariş Kodu Order Code Best.-Nr.	Stok/Stock/Lager	Ürün Kodu Product Code Produkt-Code	Ölçüler (mm) Dimensions (mm) Abmessungen (mm)						Kullanılan Uç Insert WSP	Baskı Civatası Locking Screw Verriegelungs Schraube	Aflık Shim U-Platte	Aflık Pimi Lock Pin Rohrstift	Baskı Kepi Clamp Spann pratze	Yay Spring Feder	Pul Washer U-Scheibe	Anahtar Allen Key Inbuss- Schlüssel
			D <sub>min</sub>	d	L	L1	f	h								
K441	●	S20R MTUNR 16	26	20	200	50	15	18	TNMG 1604	TC046 M5	---	---	BK022	BY043	BSP031	3 Allen
K442	●	S25S MTUNR 16	32	25	250	50	17	23								
K444	●	S32T MTUNR 16	40	32	300	60	22	30								
K446	●	S40T MTUNR 16	50	40	300	60	27	38								
K448	●	S50U MTUNR 16	63	50	350	65	35	47								
K450	●	S32T MTUNR 22	40	32	300	60	22	30	TNMG 2204	TC044 M6	TA045	BSP021	BK023	BY040	BSP030	4 Allen
K452	●	S40T MTUNR 22	50	40	300	60	27	38								
K454	●	S50U MTUNR 22	63	50	350	65	35	47								

## 93° MTUNL

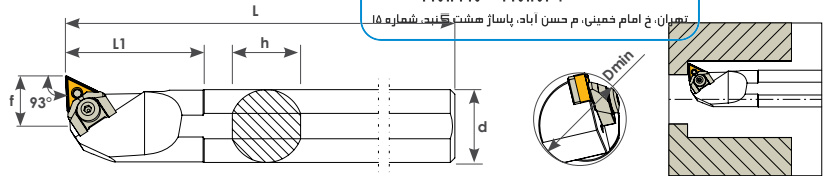

Sipariş Kodu Order Code Best.-Nr.	Stok/Stock/Lager	Ürün Kodu Product Code Produkt-Code	Ölçüler (mm) Dimensions (mm) Abmessungen (mm)						Kullanılan Uç Insert WSP	Baskı Civatası Locking Screw Verriegelungs Schraube	Aflık Shim U-Platte	Aflık Pimi Lock Pin Rohrstift	Baskı Kepi Clamp Spann pratze	Yay Spring Feder	Pul Washer U-Scheibe	Anahtar Allen Key Inbuss- Schlüssel
			D <sub>min</sub>	d	L	L1	f	h								
K519	●	S20R MTUNL 16	26	20	200	30	13	18	TNMG 1604	TC046 M5	---	---	BK022	BY043	BSP031	3 Allen
K520	●	S25S MTUNL 16	32	25	250	50	17	23								
K522	●	S32T MTUNL 16	40	32	300	60	22	30								
K524	●	S40T MTUNL 16	50	40	300	60	27	38								
K526	●	S50U MTUNL 16	63	50	350	65	35	47								
K528	●	S32T MTUNL 22	40	32	300	60	22	30	TNMG 2204	TC044 M6	TA045	BSP021	BK023	BY040	BSP030	4 Allen
K530	●	S40T MTUNL 22	50	40	300	60	27	38								
K532	●	S50U MTUNL 22	63	50	350	65	35	47								

● Stokta / In Stock / Lager ○ Sınırlı Stok / Limited Stock / Begrenzte Lagerhaltung

## 60° MTENR

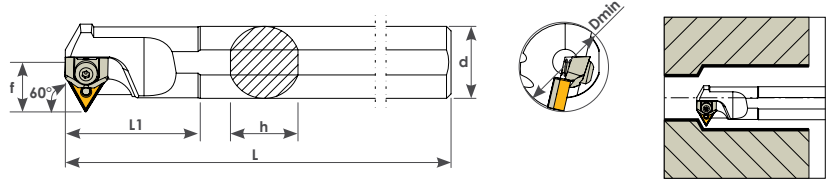

Sipariş Kodu Order Code Best.-Nr.	Stok/Stock/Lager	Ürün Kodu Product Code Produkt-Code	Ölçüler (mm) Dimensions(mm) Abmessungen (mm)						Kullanılan Uç Insert WSP	Baskı Civatası Locking Screw Verriegelungs Schraube	Aıllık Shim U-Platte	Aıllık Pimi Lock Pin Rohrstift	Baskı Kepi Clamp Spann pratze	Yay Spring Feder	Pul Washer U-Scheibe	Anahtar Allen Key Inbuss-Schlüssel
			Dmin	d	L	L1	f	h								
K456	●	S25S MTENR 16	32	25	250	60	17	23	TNMG 1604	TC046 M5	TA019	BSP 020	BK022	BY043	BSP031	3 Allen
K458	●	S32T MTENR 16	40	32	300	60	22	30								
K460	●	S40T MTENR 16	50	40	300	60	27	38								
K462	●	S50U MTENR 16	63	50	350	70	35	47								

● Stokta / In Stock / Lager ○ Sınırlı Stok / Limited Stock / Begrenzte Lagerhaltung



## 107,5° MTQNR

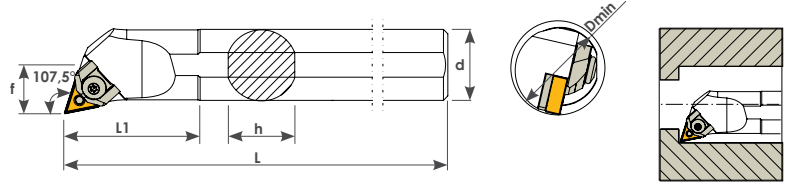

Sipariş Kodu Order Code Best.-Nr.	Stok/Stock/Lager	Ürün Kodu Product Code Produkt-Code	Ölçüler (mm) Dimensions (mm) Abmessungen (mm)						Kullanılan Uç Insert WSP	Baskı Cıvatası Locking Screw Verriegelungs Schraube	Altlık Shim U-Platte	Altlık Pimi Lock Pin Rohrstift	Baskı Kepli Clamp Spann pratze	Yay Spring Feder	Pul Washer U-Scheibe	Anahtar Allen Key Inbuss-Schlüssel
			Dmin	d	L	L1	f	h								
K365	●	S25S MTQNR 16	32	25	250	50	17	23	TNMG 1604	TC046 M5	TA019	BSP020	BK022	BY043	BSP031	3 Allen
K366	●	S32T MTQNR 16	40	32	300	60	22	30								
K367	●	S40T MTQNR 16	50	40	300	60	27	38								
K368	●	S50U MTQNR 16	63	50	350	65	35	47								

## 107,5° MTQNL

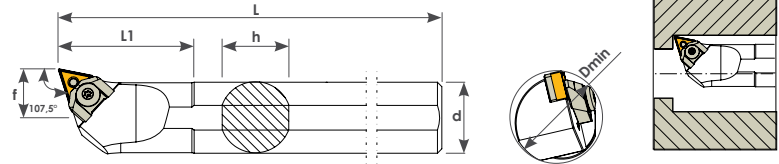

Sipariş Kodu Order Code Best.-Nr.	Stok/Stock/Lager	Ürün Kodu Product Code Produkt-Code	Ölçüler (mm) Dimensions (mm) Abmessungen (mm)						Kullanılan Uç Insert WSP	Baskı Cıvatası Locking Screw Verriegelungs Schraube	Altlık Shim U-Platte	Altlık Pimi Lock Pin Rohrstift	Baskı Kepli Clamp Spann pratze	Yay Spring Feder	Pul Washer U-Scheibe	Anahtar Allen Key Inbuss-Schlüssel
			Dmin	d	L	L1	f	h								
K537	●	S25S MTQNL 16	32	25	250	50	17	23	TNMG 1604	TC046 M5	TA019	BSP020	BK022	BY043	BSP031	3 Allen
K538	●	S32T MTQNL 16	40	32	300	60	22	30								
K539	●	S40T MTQNL 16	50	40	300	60	27	38								
K540	●	S50U MTQNL 16	63	50	350	65	35	47								

● Stokta / In Stock / Lager ○ Sınırlı Stok / Limited Stock / Begrenzte Lagerhaltung



## 93° CKUNR

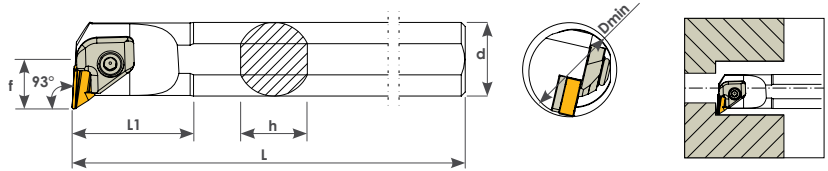

Sipariş Kodu Order Code Best.-Nr.	Stok/Stock/Lager	Ürün Kodu Product Code Produkt-Code	Ölçüler (mm) Dimensions (mm) Abmessungen (mm)							Kullanılan Uç Insert WSP	Baskı Civatası Locking Screw Verriegelungs Schraube	Ahlık Shim U-Platte	Ahlık Civatası Shim Screw U-Platte Schraube	Baskı Kepi Clamp Spann- pratze	Yay Spring Feder	Pul Washer U-Scheibe	Anahtar Allen Key Inbuss-Schlüssel
			Dmin	d	L	L1	f	h									
RK750	●	S25T CKUNR 16	32	25	300	52	20	23	KNUX 1604	TC044 M6	TA048	TC036 M3x10	BK030	BY042	BSP030	4 Allen	
RK754	●	S32U CKUNR 16	40	32	350	52	21	30									
RK756	●	S40V CKUNR 16	50	40	400	55	26	38									
RK758	●	S45V CKUNR 16	54	45	400	60	29	43									
RK760	●	S50W CKUNR 16	63	50	450	60	35	47									

**تکنیک تولز**

ابزار آلات صنعتی، تراشکاری و ماشینکاری  
تهران، خ امام خمینی، م حسن آباد، پاساژ هشت کتیبه، شماره ۱۵  
۶۶۷۱۱۶۶ - ۶۶۷۱۱۶۶





**Diş Katerleri**  
Threading Holders  
Klemmhalter  
(Außengewinde)

## Dış Çap Dış Kater/R

External Threading Toolholders/R

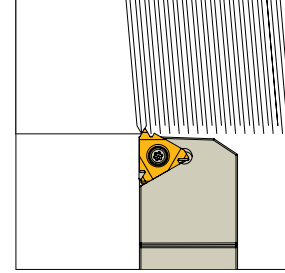
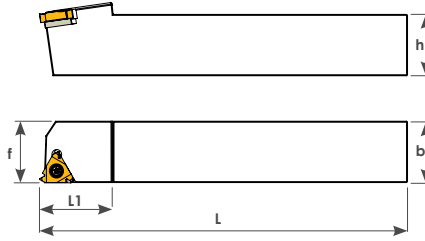
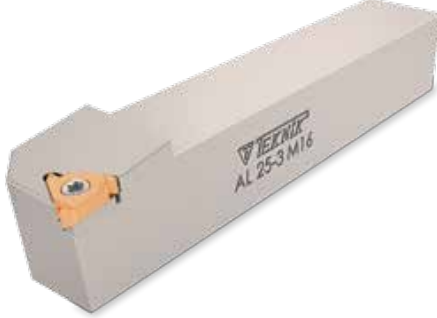

Sipariş Kodu Order Code Best.-Nr.	Stok/Stock/Lager	Ürün Kodu Product Code Produkt-Code	Ölçüler (mm) Dimensions(mm) Abmessungen (mm)					Kullanılan Uç Insert WSP	Sıkma Cıvatası Clamp Screw Torx-Schraube	Altlık Shim U-Platte	Altlık Cıvatası Shim Screw U-Platte Schraube	Anahtar Torx Key Torx-Schlüssel
			L	L1	h	f	b					
D261	●	AL 1212 ER16-J16	110	20	12	16	12	16 ER	TC070 M3,5x11	TA040	TC048 M5	T10
D259	●	AL 1616 ER16-H16	100	22	16	16	16					
D258	●	AL 2020 ER16-K16	125	25	20	20	20					
D260	●	AL 2525 ER16-M16	150	30	25	25	25					
D262	●	AL 3232 ER16-P16	170	30	32	32	32					
D266	●	AL 2525 ER22-M22	150	30	25	25	25	22 ER	TC075 M4X11	---	---	T15

## Dış Çap Dış Kater/L

External Threading Toolholders/L

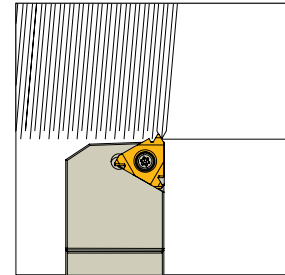
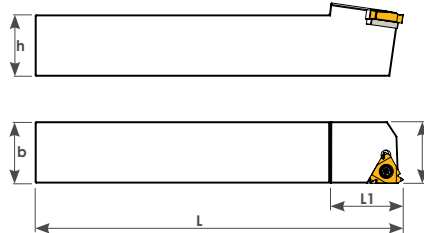
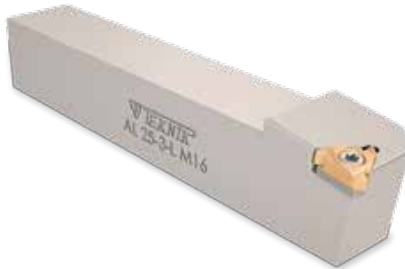

Sipariş Kodu Order Code Best.-Nr.	Stok/Stock/Lager	Ürün Kodu Product Code Produkt-Code	Ölçüler (mm) Dimensions(mm) Abmessungen (mm)					Kullanılan Uç Insert WSP	Sıkma Cıvatası Clamp Screw Torx-Schraube	Altlık Shim U-Platte	Altlık Cıvatası Shim Screw U-Platte Schraube	Anahtar Torx Key Torx-Schlüssel
			L	L1	h	f	b					
D268	●	AL 2020 EL16-K16	125	25	20	20	20	16 EL	TC070 M3,5x11	TA040	TC048 M5	T10
D269	●	AL 2525 EL16-M16	150	30	25	25	25					
D266-1	●	AL 2525 EL22-M22	150	30	25	25	25					

● Stokta / In Stock / Lager ○ Sınırlı Stok / Limited Stock / Begrenzte Lagerhaltung

## İç Çap Diş Kateri/R Internal Threading Toolholders/R

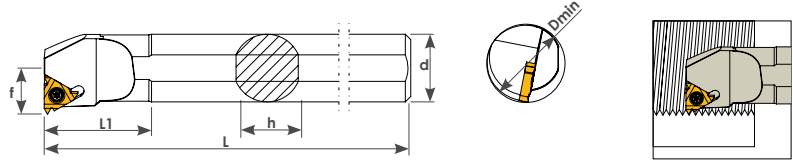
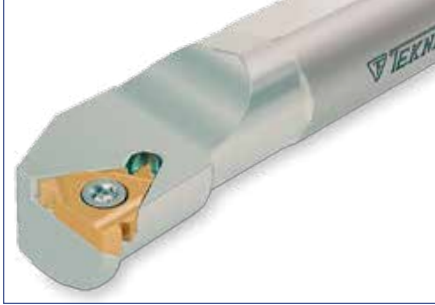

Sipariş Kodu Order Code Best.-Nr.	Stok/Stock/Lager	Ürün Kodu Product Code Produkt-Code	Ölçüler (mm) Dimensions(mm) Abmessungen (mm)						Kullanılan Uç Insert WSP	Sıkma Civatası Clamp Screw Torx-Schraube	Anahtar Torx Key Torx-Schlüssel
			Dmin	d	L	L1	f	h			
K348	●	S10J STIR-IR11	12	10	110	20	6	7	11 IR	TC060 M2,5x5,5	T8
K350	●	S12K STIR-IR11	14	12	125	24	7.2	11			
K352	●	S16Q STIR-IR16	20	16	180	40	11	15	16 IR	TC069 M3,5x8,5	T10
K354	●	S20Q STIR-IR16	24	20	180	40	13	18			
K356	●	S25R STIR-IR16	29	25	200	40	16	23			
K358	●	S32T STIR-IR16	36	32	300	40	19.5	30			
K359	●	S25R STIR-IR22	32	25	200	40	17	23	22 IR	TC075 M4x11	T15
K360	●	S32T STIR-IR22	39	32	300	60	19.5	30			
K360-1	●	S40T STIR-IR22	50	40	300	60	24.5	38			

## İç Çap Diş Kateri/L Internal Threading Toolholders/L

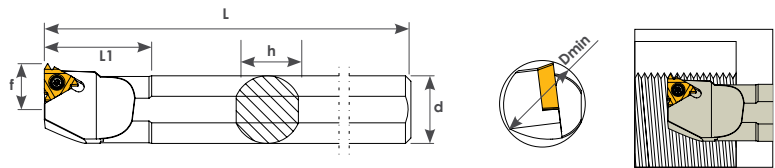
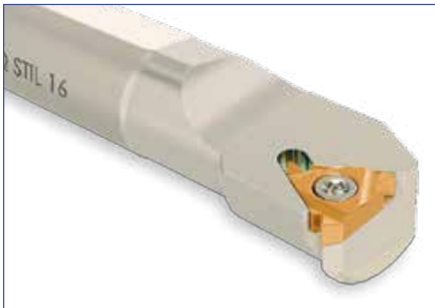

Sipariş Kodu Order Code Best.-Nr.	Stok/Stock/Lager	Ürün Kodu Product Code Produkt-Code	Ölçüler (mm) Dimensions(mm) Abmessungen (mm)						Kullanılan Uç Insert WSP	Sıkma Civatası Clamp Screw Torx-Schraube	Anahtar Torx Key Torx-Schlüssel
			Dmin	d	L	L1	f	h			
K361	●	S16Q STIL-IL16	20	16	180	40	11	15	16 IL	TC069 M3,5x8,5	T10
K362	●	S20Q STIL-IL16	24	20	180	40	13	18			
K363	●	S25R STIL-IL16	29	25	200	40	16	23			

● Stokta / In Stock / Lager ○ Sınırlı Stok / Limited Stock / Begrenzte Lagerhaltung

## Diş Çap Diş Kateri/R

External Threading Toolholders/R

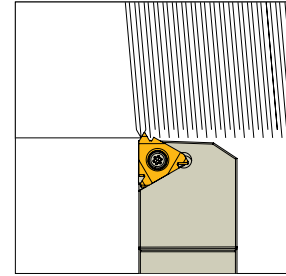
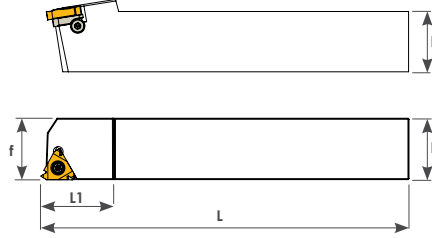

Sipariş Kodu Order Code Best.-Nr.	Stok/Stock/Lager	Ürün Kodu Product Code Produkt-Code	Ölçüler (mm) Dimensions (mm) Abmessungen (mm)					Kullanılan Uç Insert WSP	Sıkma Civatası Clamp Screw Torx-Schraube	Altlık Shim U-Platte	Pul Washer U-Scheibe	Altlık Civatası Shim Trox U-Platte Schraube	Anahtar Torx Key Torx-Schlüssel
			L	L1	h	f	b						
D500	●	TAL 1212 ER16-J16	110	20	12	16	12	16 ER	TC070 M3,5x11	TA061	BSP010	TC062 M3	T10
D501	●	TAL 1616 ER16-H16	100	22	16	16	16						
D502	●	TAL 2020 ER16-K16	125	25	20	20	20						
D503	●	TAL 2525 ER16-M16	150	30	25	25	25						
D504	●	TAL 3232 ER16 P16	170	30	32	32	32						
D505	●	TAL 2525 ER22-M22	150	30	25	25	25	22 ER	TC075 M4x11	TA062	TC062 M3	T15	
D506	●	TAL 3232 ER22-P22	170	36	32	32	32						

تکنیک تولز

ابزار آلات صنعتی، تراشکاری و ماشینکاری  
۶۶۷۱۱۷۲۹ - ۶۶۷۱۱۹۶۷  
تهران، خ امام خمینی، م حسن آباد، پاساژ هفت گنبد، شماره ۱۵

## Diş Çap Diş Kateri/L

External Threading Toolholders/L

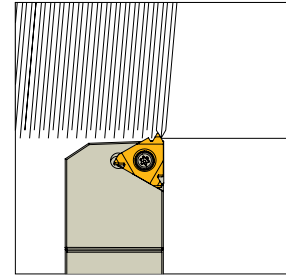
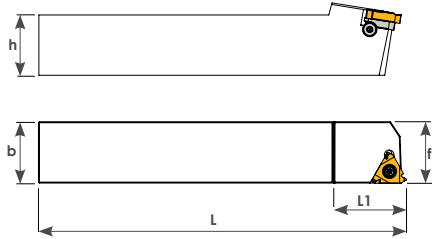

Sipariş Kodu Order Code Best.-Nr.	Stok/Stock/Lager	Ürün Kodu Product Code Produkt-Code	Ölçüler (mm) Dimensions (mm) Abmessungen (mm)					Kullanılan Uç Insert WSP	Sıkma Civatası Clamp Screw Torx-Schraube	Altlık Shim U-Platte	Pul Washer U-Scheibe	Altlık Civatası Shim Trox U-Platte Schraube	Anahtar Torx Key Torx-Schlüssel
			L	L1	h	f	b						
D508	●	TAL 1212-L EL16-J16	110	20	12	16	12	16 EL	TC070 M3,5x11	TA060	BSP010	TC062 M3	T10
D509	●	TAL 1616-L EL16-H16	100	22	16	16	16						
D510	●	TAL 2020-L EL16-K16	125	25	20	20	20						
D511	●	TAL 2525-L EL16-M16	150	30	25	25	25						
D512	●	TAL 3232-L EL16 P16	150	30	32	32	32						
D513	●	TAL 2525-L EL22-M22	150	30	25	25	25	22 EL	TC075 M4x11	TA063	TC062 M3	T15	
D515	●	TAL 3232-L EL22-P22	170	36	32	32	32						

● Stokta / In Stock / Lager ○ Sınırlı Stok / Limited Stock / Begrenzte Lagerhaltung

## İç Çap Diş Kateri/R

Internal Threading Toolholders/R

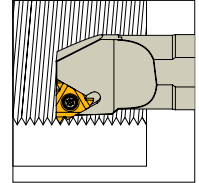
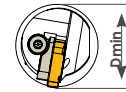
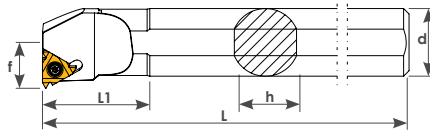

Sipariş Kodu Order Code Best.-Nr.	Stok/Stock/Lager	Ürün Kodu Product Code Produkt-Code	Ölçüler (mm) Dimensions (mm) Abmessungen (mm)						Kullanılan Uç Insert WSP	Sıkma Cıvatası Clamp Screw Torx-Schraube	Altlık Shim U-Platte	Altlık Cıvatası Shim Trox U-Platte Schraube	Anahtar Torx Key Torx-Schlüssel
			Dmin	d	L	L1	f	h					
K338	●	S20Q TTIR-IR16	24	20	180	40	13	18	16 IR	TC070 M3,5x8,5	TA060	TC062 M3	T10
K339	●	S25R TTIR-IR16	29	25	200	40	16	23					
K340	●	S32T TTIR-IR16	36	32	300	40	19,5	30					
K341	●	S40T TTIR-IR16	50	40	300	60	24,5	38					
K343	●	S25R TTIR-IR22	32	25	200	40	17	23	22 IR	TC075 M4x11	TA063	T15	
K344	●	S32T TTIR-IR22	39	32	300	40	22	30					
K345	●	S40T TTIR-IR22	50	40	300	60	24,5	38					

## İç Çap Diş Kateri/L

Internal Threading Toolholders/L

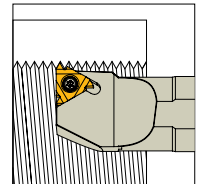
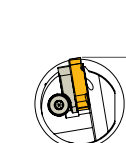
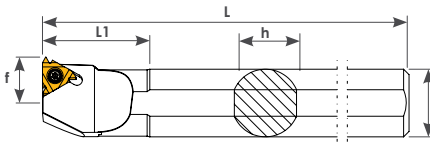

Sipariş Kodu Order Code Best.-Nr.	Stok/Stock/Lager	Ürün Kodu Product Code Produkt-Code	Ölçüler (mm) Dimensions (mm) Abmessungen (mm)						Kullanılan Uç Insert WSP	Sıkma Cıvatası Clamp Screw Torx-Schraube	Altlık Shim U-Platte	Altlık Cıvatası Shim Trox U-Platte Schraube	Anahtar Torx Key Torx-Schlüssel
			Dmin	d	L	L1	f	h					
K330	●	S20Q TTIL-IL16	24	20	180	40	13	18	16 IL	TC070 M3,5x8,5	TA061	TC062 M3	T10
K331	●	S25R TTIL-IL16	29	25	200	40	16	23					
K332	●	S32T TTIL-IL16	36	32	300	40	19,5	30					
K333	●	S40T TTIL-IL16	50	40	300	60	24,5	38					
K334	●	S25R TTIL-IL22	32	25	200	40	17	23	22 IL	TC075 M4x11	TA062	T15	
K335	●	S32T TTIL-IL22	39	32	300	40	22	30					
K336	●	S40T TTIL-IL22	50	40	300	60	24,5	38					

● Stokta / In Stock / Lager ○ Sınırlı Stok / Limited Stock / Begrenzte Lagerhaltung



**تکنیک تولز**  
ابزار آلات صنعتی ، تراشکاری و فالپساری  
۶۶۷۱۱۷۲۹ - ۶۶۷۱۱۹۶۷  
تهران، ج امام خمینی، م حسن آباد، پاساژ هشت گنبد، شماره ۱۵



**S System Kater**  
S System



## 95° SCLCR

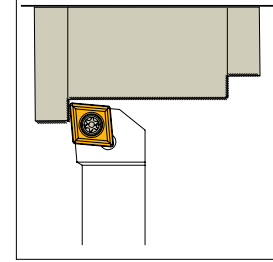
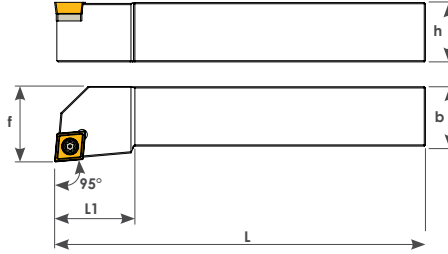
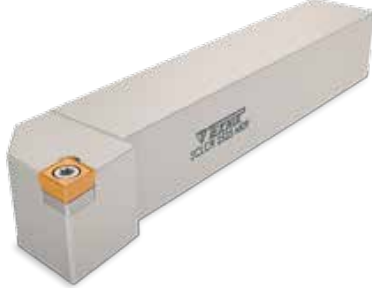

Sipariş Kodu Order Code Best.-Nr.	Stok/Stock/Lager	Ürün Kodu Product Code Produkt-Code	Ölçüler (mm) Dimensions (mm) Abmessungen (mm)					Kullanılan Uç Insert WSP	Sıkma Cıvatası Clamp Screw Torx-Schraube	Altlık Shim U-Platte	Altlık Cıvatası Shim Screw U-Platte Schraube	Anahtar Torx Key Torx-Schlüssel
			L	L1	h	f	b					
D398	●	SCLCR 1010 J06	110	10	10	12	10	CC-- 0602	TC060 M2,5x5,5	---	---	T8
D400	●	SCLCR 1212 J09	110	12	12	16	12	CC-- 09T3	TC068 M3,5x11	TA015	TC048 M5	T15
D401	●	SCLCR 1616 H09	100	16	16	20	16					
D402	●	SCLCR 2020 K09	125	25	20	25	20					
D403	●	SCLCR 2525 M09	150	25	25	32	25					

## 95° SCLCL

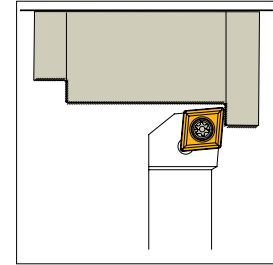
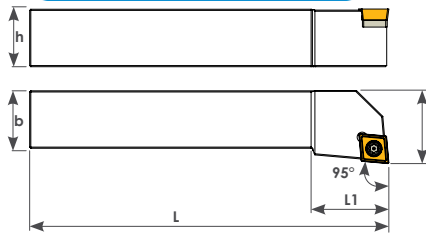

**تکنیک تولز**  
ایران آلات صنعتی، تراشکاری و قابلمساری  
تهران، ج امام خمینی، م حسن آباد، پاساژ هشت گنبد، شماره ۱۵  
۶۶۷۱۱۹۶۷ - ۶۶۷۱۱۷۲۹

Sipariş Kodu Order Code Best.-Nr.	Stok/Stock/Lager	Ürün Kodu Product Code Produkt-Code	Ölçüler (mm) Dimensions (mm) Abmessungen (mm)					Kullanılan Uç Insert WSP	Sıkma Cıvatası Clamp Screw Torx-Schraube	Altlık Shim U-Platte	Altlık Cıvatası Shim Screw U-Platte Schraube	Anahtar Torx Key Torx-Schlüssel
			L	L1	h	f	b					
D404	●	SCLCL 1010 J06	110	10	10	12	10	CC-- 0602	TC060 M2,5x5,5	---	---	T8
D405	●	SCLCL 1212 J09	110	12	12	16	12	CC-- 09T3	TC068 M3,5x11	TA015	TC048 M5	T15
D406	●	SCLCL 1616 H09	100	16	16	20	16					
D407	●	SCLCL 2020 K09	125	25	20	25	20					
D408	●	SCLCL 2525 M09	150	25	25	32	25					

● Stokta/ In Stock / Lager ○ Sınırlı Stok / Limited Stock / Begrenzte Lagerhaltung



## 90° SCACR

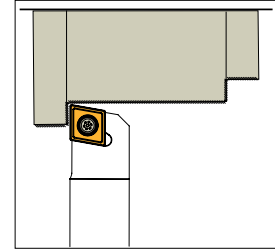
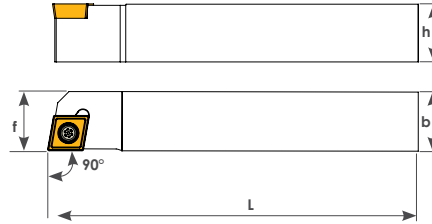

Sipariş Kodu Order Code Best.-Nr.	Stok/Stock/Lager	Ürün Kodu Product Code Produkt-Code	Ölçüler (mm) Dimensions(mm) Abmessungen (mm)				Kullanılan Uç Insert WSP	Altlık Shim U-Platte	Altlık Cıvatası Shim Trox U-Platte Schraube	Sıkma Cıvatası Clamp Screw Torx-Schraube	Anahtar Torx Key Torx-Schlüssel
			L	h	f	b					
D411	●	SCACR 1010 J06-F	110	10	10	10	CCMT 0602	---	---	TC060 M2,5x5,5	T8
D412	●	SCACR 1212 J09-F	110	12	12	12	CCMT 09T3	TA015	TC048 M5	TC068 M3,5x11	T15
D414	●	SCACR 1616 H09-F	100	16	16	16					
D416	●	SCACR 2020 K09-F	125	20	20	20					

## 95° SCLCR

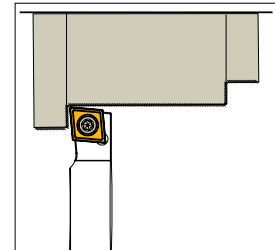
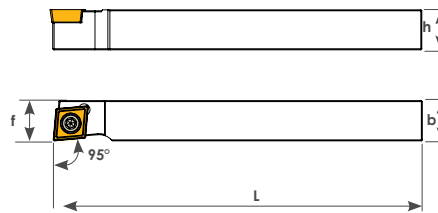

Sipariş Kodu Order Code Best.-Nr.	Stok/Stock/Lager	Ürün Kodu Product Code Produkt-Code	Ölçüler (mm) Dimensions(mm) Abmessungen (mm)				Kullanılan Uç Insert WSP	Altlık Shim U-Platte	Altlık Cıvatası Shim Trox U-Platte Schraube	Sıkma Cıvatası Clamp Screw Torx-Schraube	Anahtar Torx Key Torx-Schlüssel
			L	h	f	b					
D422	●	SCLCR 1010 J06-F	110	10	10	10	CCMT 0602	---	---	TC060 M2,5x5,5	T8
D424	●	SCLCR 1212 J06-F	110	12	12	12	CCMT 09T3	TA015	TC048 M5	TC068 M3,5x11	T15
D426	●	SCLCR 1212 J09-F	110	12	12	12					
D428	●	SCLCR 1616 H09-F	100	16	16	16					
D430	●	SCLCR 2020 K09-F	125	20	20	20					

● Stokta / In Stock / Lager ○ Sınırlı Stok / Limited Stock / Begrenzte Lagerhaltung

## 93° SDJCR

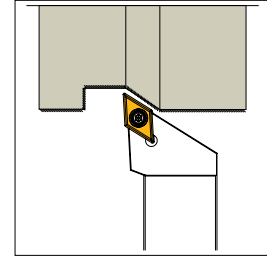
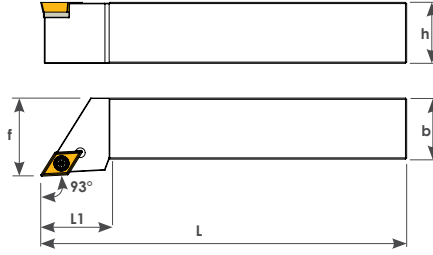

Sipariş Kodu Order Code Best.-Nr.	Stok/Stock/Lager	Ürün Kodu Product Code Produkt-Code	Ölçüler (mm) Dimensions (mm) Abmessungen (mm)					Sıkma Cıvatası Clamp Screw Torx-Schraube	Kullanılan Uç Insert WSP	Aflık Shim U-Platte	Aflık Cıvatası Shim Trox U-Platte Schraube	Anahtar Torx Key Torx-Schlüssel
			L	L1	H	f	b					
D220	●	SDJCR 1010 J07	110	12	10	12	10	TC060 M2,5x5,5	DCMT 0702	---	---	T8
D222	●	SDJCR 1212 J11	110	20	12	16	12	TC067 M3,5x9	DCMT 11T3	---	---	T15
D224	●	SDJCR 1616 H11	100	24	16	20	16	TC068 M3,5x11		TA030	TC048 M5	
D226	●	SDJCR 2020 K11	125	24	20	25	20					
D228	●	SDJCR 2525 M11	150	30	25	32	25					

## 93° SDJCL

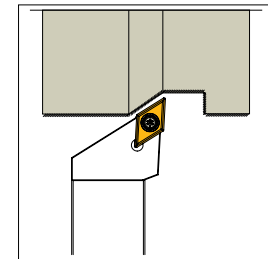
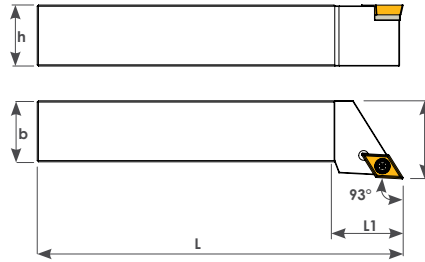



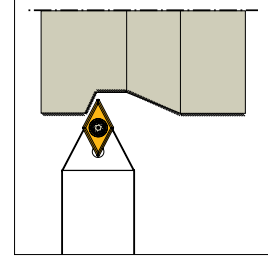
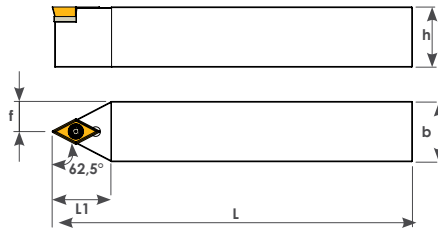

Sipariş Kodu Order Code Best.-Nr.	Stok/Stock/Lager	Ürün Kodu Product Code Produkt-Code	Ölçüler (mm) Dimensions (mm) Abmessungen (mm)					Sıkma Cıvatası Clamp Screw Torx-Schraube	Kullanılan Uç Insert WSP	Aflık Shim U-Platte	Aflık Cıvatası Shim Trox U-Platte Schraube	Anahtar Torx Key Torx-Schlüssel
			L	L1	H	f	b					
D360	●	SDJCL 1010 J07	110	12	10	12	10	TC060 M2,5x5,5	DCMT 0702	---	---	T8
D362	●	SDJCL 1212 J11	110	20	12	16	12	TC067 M3,5x9	DCMT 11T3	---	---	T15
D364	●	SDJCL 1616 H11	100	24	16	20	16	TC068 M3,5x11		TA030	TC048 M5	
D366	●	SDJCL 2020 K11	125	24	20	25	20					
D368	●	SDJCL 2525 M11	150	30	25	32	25					

● Stokta / In Stock / Lager ○ Sınırlı Stok / Limited Stock / Begrenzte Lagerhaltung

## 62,5° SDNCN

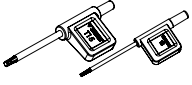

Sipariş Kodu Order Code Best.-Nr.	Stok/Stock/Lager	Ürün Kodu Product Code Produkt-Code	Ölçüler (mm) Dimensions (mm) Abmessungen (mm)					Kullanılan Uç Insert WSP	Sıkma Cıvatası Clamp Screw Torx-Schraube	Aflık Shim U-Platte	Aflık Cıvatası Shim Trox U-Platte Schraube	Anahtar Torx Key Torx-Schlüssel
			L	L1	H	f	b					
D117	●	SDNCN 1010 J07	110	15	10	5	10	DC-- 0702	TC060 M2,5x5,5	---	---	T8
D118	●	SDNCN 1212 J11	110	25	12	6	12	DC-- 11T3	TC067 M3,5x9	---	---	T15
D120	●	SDNCN 1616 H11	100	25	16	8	16	DC-- 11T3	TC068 M3,5x11	TA030	TC048 M5	
D122	●	SDNCN 2020 K11	125	25	20	10	20					
D124	●	SDNCN 2525 M11	150	25	25	12,5	25					

● Stokta / In Stock / Lager ○ Sınırlı Stok / Limited Stock / Begrenzte Lagerhaltung



## 90° SDACR

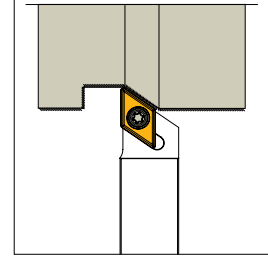
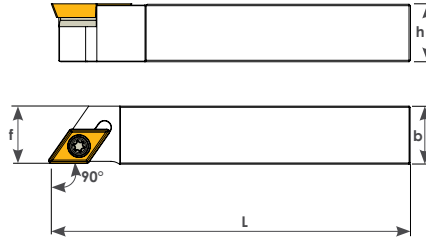

Sipariş Kodu Order Code Best.-Nr.	Stok/Stock/Lager	Ürün Kodu Product Code Produkt-Code	Ölçüler (mm) Dimensions (mm) Abmessungen (mm)				Kullanılan Uç Insert WSP	Sıkma Civatası Clamp Screw Torx-Schraube	Altlık Shim U-Platte	Altlık Civatası Shim Trox U-Platte Schraube	Anahtar Torx Key Torx-Schlüssel
			L	h	f	b					
D434	●	SDACR 1010 J07-F	110	10	10	10	DCMT 0702	TC060 M2,5x5,5	---	---	T8
D436	●	SDACR 1212 J07-F	110	12	12	12					
D438	●	SDACR 1616 H07-F	100	16	16	16					
D440	●	SDACR 1212 J11-F	110	12	12	12	DCMT 11T3	TC068 M3,5x11	TA030	TC048 M5	T15
D442	●	SDACR 1616 H11-F	100	16	16	16					
D444	●	SDACR 2020 K11-F	125	20	20	20					

## 93° SDJCR

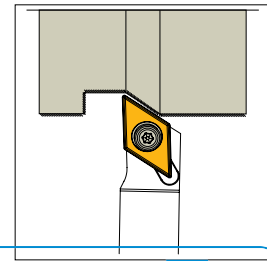
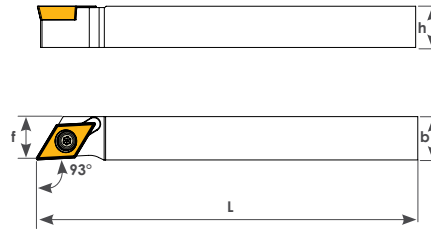

**تکنیک تولز**

ابزار آلات صنعتی، تراشکاری و ماشینکاری

تهران، خ امام خمینی، م حسن آباد، پاساژ هشت گنبد، شماره 16

۶۶۷۱۱۷۲۹ - ۶۶۷۱۱۹۶۷

Sipariş Kodu Order Code Best.-Nr.	Stok/Stock/Lager	Ürün Kodu Product Code Produkt-Code	Ölçüler (mm) Dimensions (mm) Abmessungen (mm)				Kullanılan Uç Insert WSP	Sıkma Civatası Clamp Screw Torx-Schraube	Anahtar Torx Key Torx-Schlüssel
			L	h	f	b			
D452	●	SDJCR 1010 J07-F	110	10	10	10	DCMT 0702	TC060 M2,5x5,5	T8
D454	●	SDJCR 1212 J07-F	110	12	12	12			
D456	●	SDJCR 1616 H07-F	100	16	16	16			
D457	●	SDJCR 1212 J11-F	110	12	12	12	DCMT 11T3	TC067 M3,5x9	

● Stokta / In Stock / Lager ○ Sınırlı Stok / Limited Stock / Begrenzte Lagerhaltung

## 107,5° SDHCR

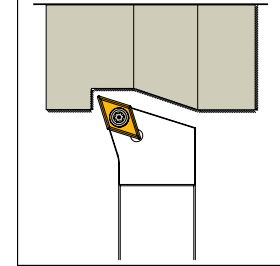
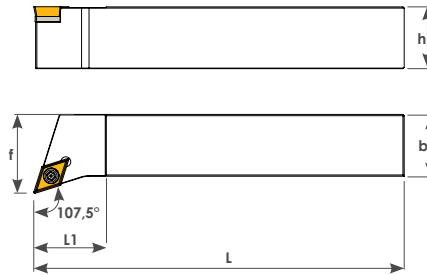

Sipariş Kodu Order Code Best.-Nr.	Stok/Stock/Lager	Ürün Kodu Product Code Produkt-Code	Ölçüler (mm) Dimensions(mm) Abmessungen (mm)					Kullanılan Uç Insert WSP	Sıkma Cıvatası Clamp Screw Torx-Schraube	Altlık Shim U-Platte	Altlık Cıvatası Shim Screw U-Platte Schraube	Anahtar Torx Key Torx-Schlüssel
			L	L1	h	f	b					
D250	●	SDHCR 2020 K11	125	26	20	25	20	DCMT 11T3	TC068 M3,5x11	TA030	TC048 M5	T15
D252	●	SDHCR 2525 M11	150	26	25	32	25					



## 107,5° SDHCL

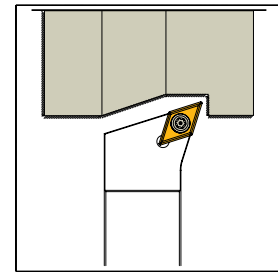
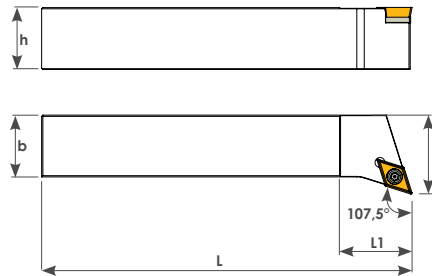

Sipariş Kodu Order Code Best.-Nr.	Stok/Stock/Lager	Ürün Kodu Product Code Produkt-Code	Ölçüler (mm) Dimensions(mm) Abmessungen (mm)					Kullanılan Uç Insert WSP	Sıkma Cıvatası Clamp Screw Torx-Schraube	Altlık Shim U-Platte	Altlık Cıvatası Shim Screw U-Platte Schraube	Anahtar Torx Key Torx-Schlüssel
			L	L1	h	f	b					
D350	●	SDHCL 2020 K11	125	26	20	25	20	DCMT 11T3	TC068 M3,5x11	TA030	TC048 M5	T15
D352	●	SDHCL 2525 M11	150	26	25	32	25					

● Stokta/ In Stock / Lager ○ Sınırlı Stok / Limited Stock / Begrenzte Lagerhaltung

## 107,5° SVHCR

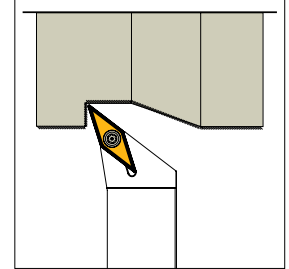
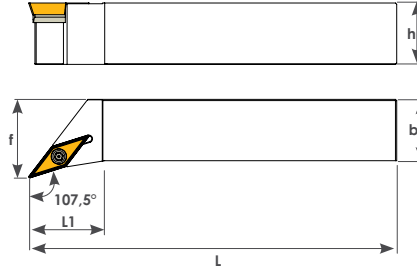

Sipariş Kodu Order Code Best.-Nr.	Stok/Stock/Lager	Ürün Kodu Product Code Produkt-Code	Ölçüler (mm) Dimensions(mm) Abmessungen (mm)					Kullanılan Uç Insert WSP	Sıkma Cıvatası Clamp Screw Torx-Schraube	Altlık Shim U-Platte	Altlık Cıvatası Shim Screw U-Platte Schraube	Anahtar Torx Key Torx-Schlüssel
			L	L1	h	f	b					
D254	●	SVHCR 2020 K16	125	30	20	25	20	VCMT 1604	TC068 M3,5x11	TA034	TC048 M5	T15
D256	●	SVHCR 2525 M16	150	30	25	32	25					

**تکنیک تولز**  
ابزار آلات صنعتی، تراشکاری و ماشینکاری  
۶۶۷۱۱۶۶ - ۶۶۷۱۱۶۹  
تهران، خ امام خمینی، م حسن آباد، پاساژ هشت گنبد، شماره ۱۵

## 107,5° SVHCL

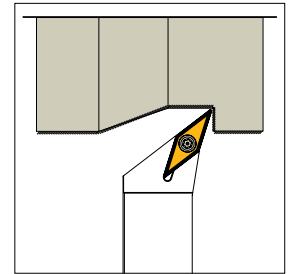
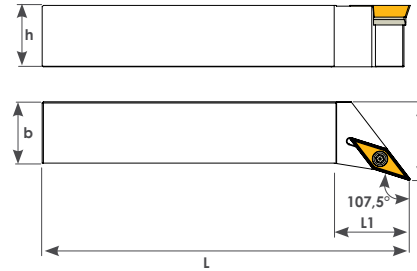

Sipariş Kodu Order Code Best.-Nr.	Stok/Stock/Lager	Ürün Kodu Product Code Produkt-Code	Ölçüler (mm) Dimensions(mm) Abmessungen (mm)					Kullanılan Uç Insert WSP	Sıkma Cıvatası Clamp Screw Torx-Schraube	Altlık Shim U-Platte	Altlık Cıvatası Shim Screw U-Platte Schraube	Anahtar Torx Key Torx-Schlüssel
			L	L1	h	f	b					
D354	●	SVHCL 2020 K16	125	30	20	25	20	VCMT 1604	TC068 M3,5x11	TA034	TC048 M5	T15
D356	●	SVHCL 2525 M16	150	30	25	32	25					

● Stokta / In Stock / Lager ○ Sınırlı Stok / Limited Stock / Begrenzte Lagerhaltung

## 107,5 SVHBR

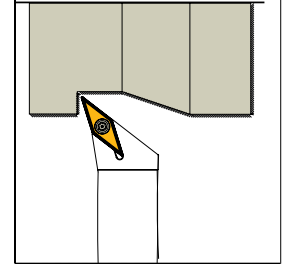
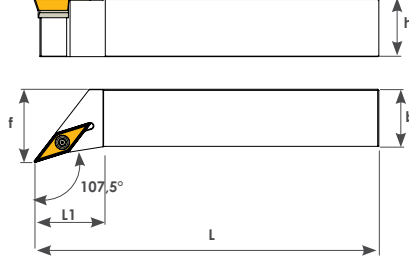

Sipariş Kodu Order Code Best.-Nr.	Stok/Stock/Lager	Ürün Kodu Product Code Produkt-Code	Ölçüler (mm) Dimensions(mm) Abmessungen (mm)					Kullanılan Uç Insert WSP	Sıkma Cıvatası Clamp Screw Torx-Schraube	Altlık Shim U-Platte	Altlık Cıvatası Shim Screw U-Platte Schraube	Anahtar Torx Key Torx-Schlüssel
			L	L1	h	f	b					
D354-1	●	SVHBR 2020 K16	125	33	20	25	20	VBMT 1604	TC068 M3,5x11	TA034	TC048 M5	T15
D356-1	●	SVHBR 2525 M16	150	40	25	32	25					

**تکنیک تولز**  
ابزار آلات صنعتی، تراشکاری و قالبسازی  
۶۶۷۱۱۹۶۷ - ۶۶۷۱۱۷۲۹  
تهران، خ امام خمینی، م حسن آباد، پاساژ هشت گنبد، شماره ۱۵

## 107,5 SVHBL

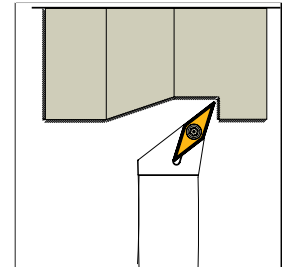
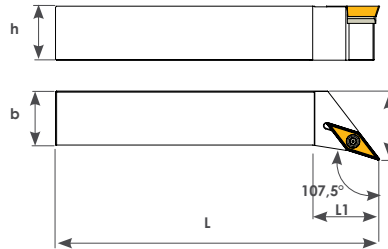

Sipariş Kodu Order Code Best.-Nr.	Stok/Stock/Lager	Ürün Kodu Product Code Produkt-Code	Ölçüler (mm) Dimensions(mm) Abmessungen (mm)					Kullanılan Uç Insert WSP	Sıkma Cıvatası Clamp Screw Torx-Schraube	Altlık Shim U-Platte	Altlık Cıvatası Shim Screw U-Platte Schraube	Anahtar Torx Key Torx-Schlüssel
			L	L1	h	f	b					
D355	●	SVHBL 2020 K16	125	33	20	25	20	VBMT 1604	TC068 M3,5x11	TA034	TC048 M5	T15
D356-2	●	SVHBL 2525 M16	150	40	25	32	25					

● Stokta / In Stock / Lager ○ Sınırlı Stok / Limited Stock / Begrenzte Lagerhaltung

## 93° SVJBR

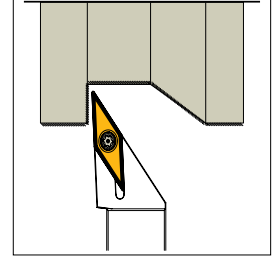
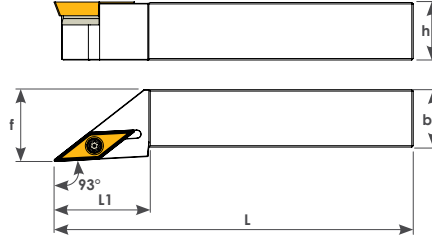

Sipariş Kodu Order Code Best.-Nr.	Stok/Stock/Lager	Ürün Kodu Product Code Produkt-Code	Ölçüler (mm) Dimensions (mm) Abmessungen (mm)					Kullanılan Uç Insert WSP	Sıkma Cıvatası Clamp Screw Torx-Schraube	Aflık Shim U-Platte	Aflık Cıvatası Shim Trox U-Platte Schraube	Anahtar Torx Key Torx-Schlüssel
			L	L1	H	f	b					
D230	●	SVJBR 1010 J11	110	21	10	12	10	VBMT 1103	TC060 M2,5x5,5	---	---	T8
D232	●	SVJBR 1212 J11	110	21	12	16	12					
D234	●	SVJBR 1616 H11	100	21	16	20	16					
D235	●	SVJBR 1616 H16	100	27	16	20	16	VBMT 1604	TC068 M3,5x11	TA034	TC048 M5	T15
D236	●	SVJBR 2020 K16	125	33	20	25	20					
D238	●	SVJBR 2525 M16	150	39	25	32	25					
D238-1	●	SVJBR 3232 P16	170	40	32	40	32					

## 93° SVJBL

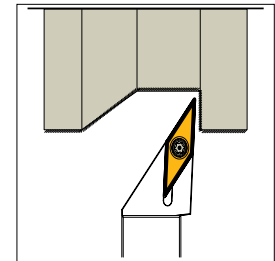
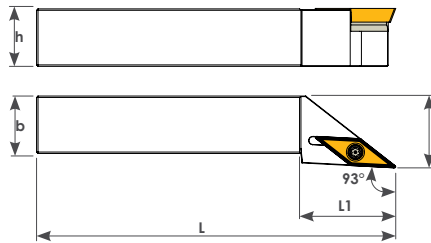

Sipariş Kodu Order Code Best.-Nr.	Stok/Stock/Lager	Ürün Kodu Product Code Produkt-Code	Ölçüler (mm) Dimensions (mm) Abmessungen (mm)					Kullanılan Uç Insert WSP	Sıkma Cıvatası Clamp Screw Torx-Schraube	Aflık Shim U-Platte	Aflık Cıvatası Shim Trox U-Platte Schraube	Anahtar Torx Key Torx-Schlüssel
			L	L1	H	f	b					
D370	●	SVJBL 1010 J11	110	21	10	12	10	VBMT 1103	TC060 M2,5x5,5	---	---	T8
D372	●	SVJBL 1212 J11	110	21	12	16	12					
D373	●	SVJBL 1616 H11	100	21	16	20	16					
D374	●	SVJBL 1616 H16	100	27	16	20	16	VBMT 1604	TC068 M3,5x11	TA034	TC048 M5	T15
D380	●	SVJBL 2020 K16	125	33	20	25	20					
D382	●	SVJBL 2525 M16	150	39	25	32	25					
D382-1	●	SVJBL 3232 P16	170	40	32	40	32					

● Stokta / In Stock / Lager ○ Sınırlı Stok / Limited Stock / Begrenzte Lagerhaltung



## 72,5° SVVBN

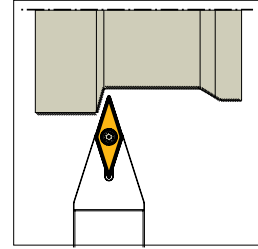
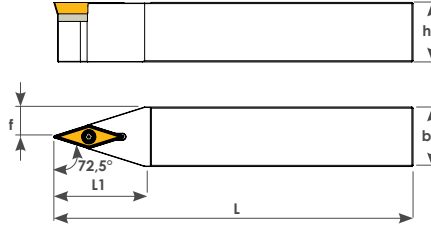

Sipariş Kodu Order Code Best.-Nr.	Stok/Stock/Lager	Ürün Kodu Product Code Produkt-Code	Ölçüler (mm) Dimensions (mm) Abmessungen (mm)					Kullanılan Uç Insert WSP	Sıkma Cıvatası Clamp Screw Torx-Schraube	Altlık Shim U-Platte	Altlık Cıvatası Shim Trox U-Platte Schraube	Anahtar Torx Key Torx-Schlüssel
			L	L1	H	f	b					
D131	●	SVVBN 1212 J11	110	23	12	6	12	VBMT 1103	TC060 M2,5x5,5	---	---	T8
D132	●	SVVBN 1616 H16	100	27	16	8	16	VBMT 1604	TC068 M3,5x11	TA034	TC048 M5	T15
D138	●	SVVBN 2020 K16	125	35	20	10	20					
D140	●	SVVBN 2525 M16	150	40	25	12,5	25					

● Stokta / In Stock / Lager ○ Sınırlı Stok / Limited Stock / Begrenzte Lagerhaltung







## 93° SVJBR

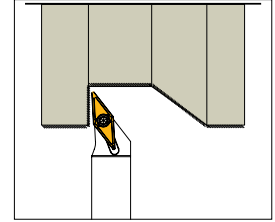

تکنیک تولز



ابزار آلات صنعتی، تراشکاری و قالبسازی  
۶۶۷۱۹۶۷ - ۶۶۷۱۷۲۹  
تهران، خ امام خمینی، م حسن آباد، پاساژ هشت گنبد، شماره ۱۵

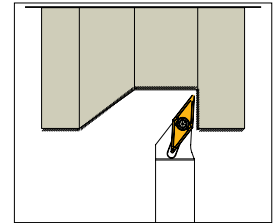
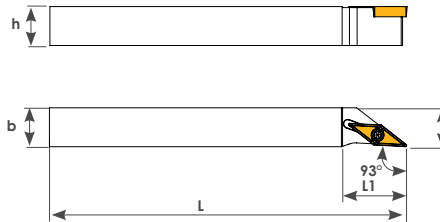

Sipariş Kodu Order Code Best.-Nr.	Stok/Stock/Lager	Ürün Kodu Product Code Produkt-Code	Ölçüler (mm) Dimensions (mm) Abmessungen (mm)					Kullanılan Uç Insert WSP	Sıkma Civatası Clamp Screw Torx-Schraube	Anahtar Torx Key Torx-Schlüssel
			L	L1	H	f	b			
D128	●	SVJBR 1010 J11-F	110	20	10	10	10	VBMT 1103	TC060 M2,5x5,5	T8
D129	●	SVJBR 1212 J11-F	110	20	12	12	12			
D130	●	SVJBR 1616 H11-F	100	25	16	16	16			

## 93° SVJBL



Sipariş Kodu Order Code Best.-Nr.	Stok/Stock/Lager	Ürün Kodu Product Code Produkt-Code	Ölçüler (mm) Dimensions (mm) Abmessungen (mm)					Kullanılan Uç Insert WSP	Sıkma Civatası Clamp Screw Torx-Schraube	Anahtar Torx Key Torx-Schlüssel
			L	L1	H	f	b			
D395	●	SVJBL 1010 J11-F	110	20	10	10	10	VBMT 1103	TC060 M2,5x5,5	T8
D396	●	SVJBL 1212 J11-F	110	20	12	12	12			
D397	●	SVJBL 1616 H11-F	100	25	16	16	16			

● Stokta / In Stock / Lager ○ Sınırlı Stok / Limited Stock / Begrenzte Lagerhaltung

## 93° SVJCR

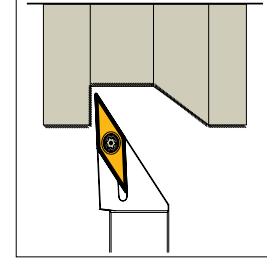
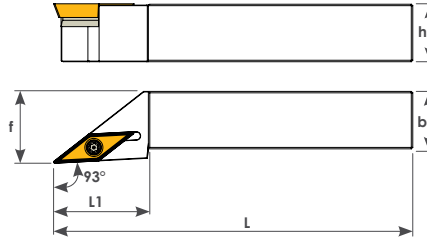

Sipariş Kodu Order Code Best.-Nr.	Stok/Stock/Lager	Ürün Kodu Product Code Produkt-Code	Ölçüler (mm) Dimensions (mm) Abmessungen (mm)						Kullanılan Uç Insert WSP	Sıkma Cıvatası Clamp Screw Torx-Schraube	Aflık im U-Platte	Aflık Cıvatası Shim Trox U-Platte Schraube	Anahtar Torx Key Torx-Schlüssel
			L	L1	H	f	b						
D239	●	SVJCR 1010 J11	110	21	10	12	10	VCMT 1103	TC060 M2,5x5,5	---	---	T8	
D240	●	SVJCR 1212 J11	110	21	12	16	12						
D241	●	SVJCR 1616 H11	100	21	16	20	16						
D242	●	SVJCR 2020 K11	125	30	20	25	20						
D243	●	SVJCR 2525 M11	150	30	25	32	25						
D244	●	SVJCR 1616 H16	100	27	16	20	16	VCMT 1604	TC068 M3,5x11	TA034	TC048 M5	T15	
D246	●	SVJCR 2020 K16	125	33	20	25	20						
D247	●	SVJCR 2525 M16	150	39	25	32	25						
D248	●	SVJCR 2525 M16	150	39	25	32	25						

## 93° SVJCL

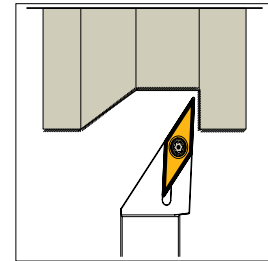
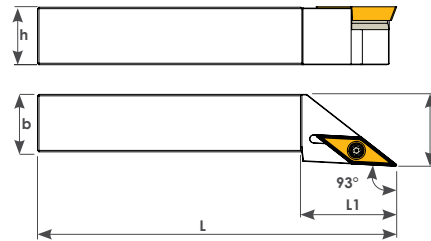

Sipariş Kodu Order Code Best.-Nr.	Stok/Stock/Lager	Ürün Kodu Product Code Produkt-Code	Ölçüler (mm) Dimensions (mm) Abmessungen (mm)						Kullanılan Uç Insert WSP	Sıkma Cıvatası Clamp Screw Torx-Schraube	Aflık im Shim U-Platte	Aflık Cıvatası Shim Trox U-Platte Schraube	Anahtar Torx Key Torx-Schlüssel
			L	L1	H	f	b						
D383	●	SVJCL 1010 J11	110	21	10	12	10	VCMT 1103	TC060 M2,5x5,5	---	---	T8	
D384	●	SVJCL 1212 J11	110	21	12	16	12						
D385	●	SVJCL 1616 H11	100	21	16	20	16						
D386	●	SVJCL 2020 K11	125	30	20	25	20						
D387	●	SVJCL 2525 M11	150	30	25	32	25						
D388	●	SVJCL 1616 H16	100	27	16	20	16	VCMT 1604	TC068 M3,5x11	TA034	TC048 M5	T15	
D390	●	SVJCL 2020 K16	125	33	20	25	20						
D391	●	SVJCL 2525 M16	150	39	25	32	25						
D392	●	SVJCL 2525 M16	150	39	25	32	25						

● Stokta / In Stock / Lager ○ Sınırlı Stok / Limited Stock / Begrenzte Lagerhaltung

## 90° SVJCR

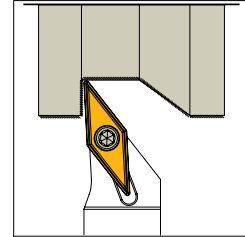
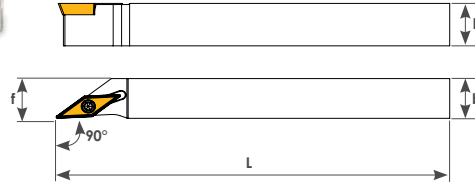

Sipariş Kodu Order Code Best.-Nr.	Stok/Stock/Lager	Ürün Kodu Product Code Produkt-Code	Ölçüler (mm) Dimensions (mm) Abmessungen (mm)				Kullanılan Uç Insert WSP	Sıkma Civatası Clamp Screw Torx-Schraube	Anahtar Torx Key Torx-Schlüssel
			L	h	f	b			
D460	●	SVJCR 1212 J11-F	110	12	12	12	VCMT 1103	TC060 M2,5x5,5	T8
D462	●	SVJCR 1616 H11-F	100	16	16	16			

● Stokta / In Stock / Lager ○ Sınırlı Stok / Limited Stock / Begrenzte Lagerhaltung

## 72,5° SVVCN

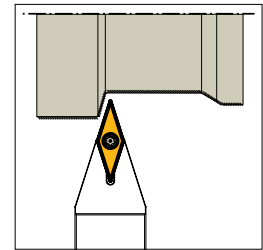
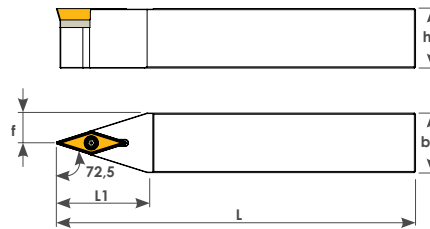

Sipariş Kodu Order Code Best.-Nr.	Stok/Stock/Lager	Ürün Kodu Product Code Produkt-Code	Ölçüler (mm) Dimensions (mm) Abmessungen (mm)					Kullanılan Uç Insert WSP	Sıkma Civatası Clamp Screw Torx-Schraube	Altlık Shim U-Platte	Altlık Civatası Shim Trox U-Platte Schraube	Anahtar Torx Key Torx-Schlüssel
			L	L1	H	f	b					
D142	●	SVVCN 1212 J11	110	23	12	6	12	VC-- 1103	TC060 M2,5x5,5	---	---	T8
D144	●	SVVCN 1616 H16	100	27	16	8	16	VCMT 1604	TC068 M3,5x11	TA034	TC048 M5	T15
D150	●	SVVCN 2020 K16	125	35	20	10	20					
D152	●	SVVCN 2525 M16	150	40	25	12.5	25					

● Stokta / In Stock / Lager ○ Sınırlı Stok / Limited Stock / Begrenzte Lagerhaltung

## 30° SRGCR

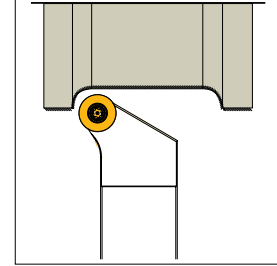
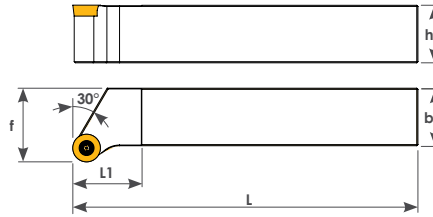

Sipariş Kodu Order Code Best.-Nr.	Stok/Stock/Lager	Ürün Kodu Product Code Produkt-Code	Ölçüler (mm) Dimensions (mm) Abmessungen (mm)					Kullanılan Uç Insert WSP	Sıkma Cıvatası Clamp Screw Torx-Schraube	Anahtar Torx Key Torx-Schlüssel
			L	L1	h	f	b			
D280	●	SRGCR 2020 K08	125	20	20	25	20	RCMT 0803	TC065 M3x7	T8
D282	●	SRGCR 2525 M08	150	25	25	32	25			
D284	●	SRGCR 2020 K10	125	20	20	25	20	RCMT 1003	TC067 M3,5x9	T15
D286	●	SRGCR 2525 M10	150	30	25	32	25			
D288	●	SRGCR 2020 K12	125	30	20	25	20	RCMT 1204	TC067 M3,5x9	T15
D290	●	SRGCR 2525 M12	150	25	25	32	25			

## 30° SRGCL

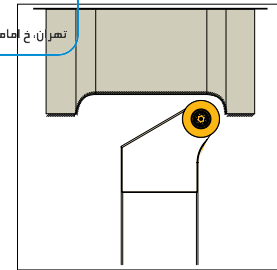
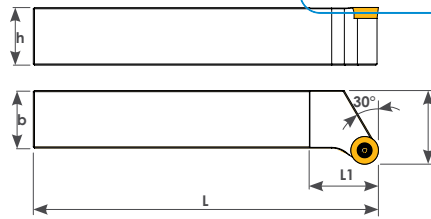

**تکنیک تولز**  
ابزار آلات صنعتی، تراشکاری و ماشینکاری  
۶۶۷۱۱۷۲۹ - ۶۶۷۱۱۹۶۷  
تهران، خ امام خمینی، م حسن آباد، پاساژ هشت گنبد، شماره ۱۵

Sipariş Kodu Order Code Best.-Nr.	Stok/Stock/Lager	Ürün Kodu Product Code Produkt-Code	Ölçüler (mm) Dimensions (mm) Abmessungen (mm)					Kullanılan Uç Insert WSP	Sıkma Cıvatası Clamp Screw Torx-Schraube	Anahtar Torx Key Torx-Schlüssel
			L	L1	h	f	b			
D293	●	SRGCL 2020 K08	125	20	20	25	20	RCMT 0803	TC065 M3x7	T8
D294	●	SRGCL 2525 M08	150	25	25	32	25			
D283	●	SRGCL 2020 K10	125	20	20	25	20	RCMT 1003	TC067 M3,5x9	T15
D292	●	SRGCL 2525 M10	150	25	25	32	25			
D281	●	SRGCL 2020 K12	125	30	20	25	20	RCMT 1204	TC067 M3,5x9	T15
D291	●	SRGCL 2525 M12	150	25	25	32	25			

● Stokta / In Stock / Lager ○ Sınırlı Stok / Limited Stock / Begrenzte Lagerhaltung

تکنیک تولز

ابزار آلات صنعتی، تراشکاری و قالبسازی  
تهران، خ امام خمینی، م حسن آباد، پاساژ هشت گنبد، شماره ۱۵  
۶۶۷۱۱۷۲۹ - ۶۶۷۱۱۹۶۷

## SRDCN

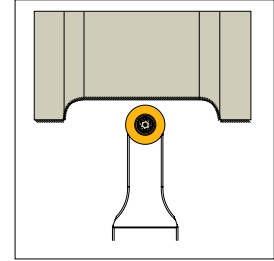
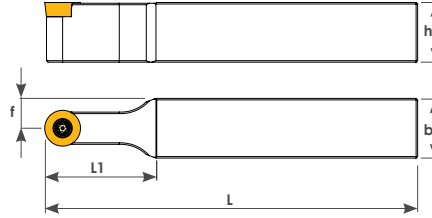

Sipariş Kodu Order Code Best.-Nr.	Stok/Stock/Lager	Ürün Kodu Product Code Produkt-Code	Ölçüler (mm) Dimensions (mm) Abmessungen (mm)					Kullanılan Uç Insert WSP	Baskı Civatası Locking Screw Verriegelungs Schraube	Anahtar Torx Key Torx-Schlüssel
			L	L1	h	f	b			
D270	●	SRDCN 2020 K08	125	25	20	10	20	RCMT 0803	TC065 M3x7	T8
D271	●	SRDCN 2525 M08	150	35	25	12.5	25			
D272	●	SRDCN 2020 K10	125	35	20	10	20	RCMT 1003	TC067 M3,5x9	T15
D274	●	SRDCN 2525 M10	150	35	25	12.5	25			
D276	●	SRDCN 2020 K12	125	25	20	10	20	RCMT 1204	TC067 M3,5x9	T15
D278	●	SRDCN 2525 M12	150	35	25	12.5	25			
D273	●	SRDCN 2525 M16	150	35	25	12.5	25	RCMT 1606	TC084 M5x13	T20

● Stokta / In Stock / Lager ○ Sınırlı Stok / Limited Stock / Begrenzte Lagerhaltung

## TIRTIL Kater

Knurling Tool

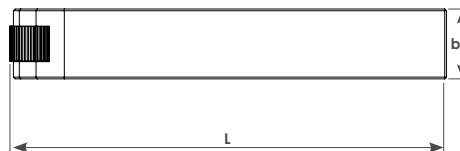

Sipariş Kodu Order Code Best.-Nr.	Stok/Stock/Lager	Ürün Kodu Product Code Produkt-Code	Ölçüler (mm) Dimensions (mm) Abmessungen (mm)		
			L	h	b
P100	●	16-20 CNC TIRTIL	125	16	20
P102	●	20-20 CNC TIRTIL	125	20	20
P104	●	25-25 CNC TIRTIL	150	25	25

● Stokta / In Stock / Lager ○ Sınırlı Stok / Limited Stock / Begrenzte Lagerhaltung

## 95° SCLCR

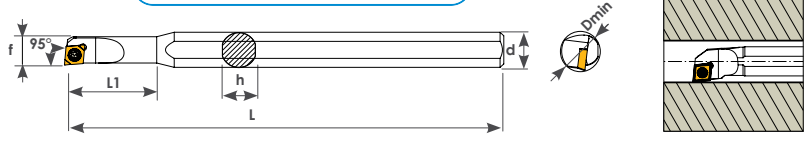

Sipariş Kodu Order Code Best.-Nr.	Stok/Stock/Lager	Ürün Kodu Product Code Produkt-Code	Ölçüler (mm) Dimensions (mm) Abmessungen (mm)						Kullanılan Uç Insert WSP	Sıkma Civatası Clamp Screw Torx-Schraube	Anahtar Torx Key Torx-Schlüssel
			Dmin	d	L	L1	f	h			
K097	●	S05-08H SCLCR 03	5	8	100	15	2,5	7	CC-- 0301	TC090 M1,6	T6
K098	●	S06-08H SCLCR 03	6	8	100	18	3	7			
K099	●	S07-08H SCLCR 04	7	8	100	21	3,5	7			

## 95° SCLCR

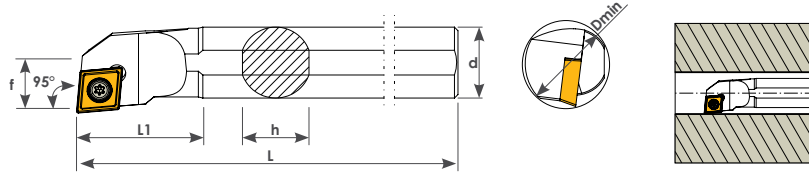



Sipariş Kodu Order Code Best.-Nr.	Stok/Stock/Lager	Ürün Kodu Product Code Produkt-Code	Ölçüler (mm) Dimensions (mm) Abmessungen (mm)						Kullanılan Uç Insert WSP	Sıkma Civatası Clamp Screw Torx-Schraube	Anahtar Torx Key Torx-Schlüssel
			Dmin	d	L	L1	f	h			
K100	●	S06-08H SCLCR 06	10	8	100	25	4,3	7	CC-- 0602	TC060 M2,5x5,5	T8
K102	●	S08H SCLCR 06	10	8	100	20	5,5	7			
K104	●	S10J SCLCR 06	12	10	110	20	6	9			
K105	●	S10K SCLCR 06	12	10	125	20	6	9			
K106	●	S12K SCLCR 06	16	12	125	24	9	11			
K107	●	S12Q SCLCR 06	16	12	180	24	9	11			
K108	●	S14-16Q SCLCR 09	20	16	180	45	10	15			
K110	●	S16Q SCLCR 09	20	16	180	30	11	15			
K111	●	S16R SCLCR 09	20	16	200	30	11	15			
K112	●	S18-20Q SCLCR 09	24	20	180	37	12	18			
K114	●	S20Q SCLCR 09	25	20	180	37	13	18			
K115	●	S20S SCLCR 09	25	20	250	37	13	18			
K116	●	S25R SCLCR 09	32	25	200	40	17	23			
K117	●	S25T SCLCR 09	32	25	300	40	17	23			

● Stokta / In Stock / Lager ○ Sınırlı Stok / Limited Stock / Begrenzte Lagerhaltung

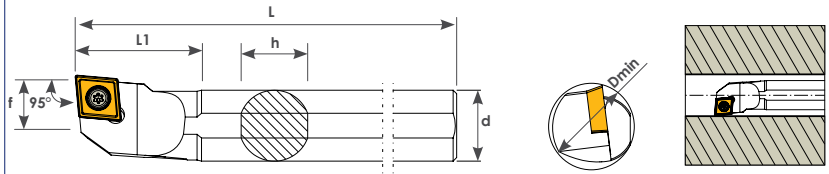
## 95° SCLCL

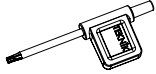

Sipariş Kodu Order Code Best.-Nr.	Stok/Stock/Lager	Ürün Kodu Product Code Produkt-Code	Ölçüler (mm) Dimensions(mm) Abmessungen (mm)						Kullanılan Uç Insert WSP	Sıkma Civatası Clamp Screw Torx-Schraube	Anahtar Torx Key Torx-Schlüssel
			Dmin	d	L	L1	f	h			
K230	●	S06-08H SCLCL 06	9	8	100	25	4.3	7	CC-- 0602	TC060 M2,5x5,5	T8
K232	●	S08H SCLCL 06	10	8	100	20	5.5	7			
K234	●	S10J SCLCL 06	12	10	110	20	6	9			
K236	●	S12K SCLCL 06	16	12	125	24	9	11			
K238	●	S14-16Q SCLCL 09	19	16	180	45	10	15	CC--09T3	TC067 M3,5x9	T15
K240	●	S16Q SCLCL 09	20	16	180	30	11	15			
K241	●	S16R SCLCL 09	20	16	200	30	11	15			
K244	●	S20Q SCLCL 09	25	20	180	37	12	18			
K245	●	S20S SCLCL 09	25	20	250	37	13	18			
K246	●	S25R SCLCL 09	32	25	200	40	17	23			

● Stokta / In Stock / Lager ○ Sınırlı Stok / Limited Stock / Begrenzte Lagerhaltung



## 93° SDUCR

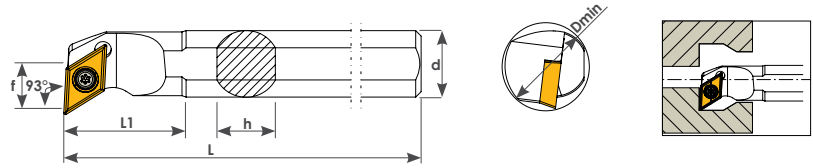

Sipariş Kodu Order Code Best.-Nr.	Stok/Stock/Lager	Ürün Kodu Product Code Produkt-Code	Ölçüler (mm) Dimensions (mm) Abmessungen (mm)						Kullanılan Uç Insert WSP	Sıkma Cıvatası Clamp Screw Torx-Schraube	Anahtar Torx Key Torx-Schlüssel
			Dmin	d	L	L1	f	h			
K120	●	S10J SDUCR 07	12	10	110	20	7	9	DC-- 0702	TC060 M2,5x5,5	T8
K122	●	S12K SDUCR 07	16	12	125	24	9	11			
K123	●	S12Q SDUCR 07	16	12	180	24	9	11			
K124	●	S14-16Q SDUCR 07	20	16	180	40	10,5	15			
K126	●	S16Q SDUCR 07	20	16	180	30	11	15	DC--11T3	TC067 M3,5x9	T15
K125	●	S14-16Q SDUCR 11	20	16	180	45	10,5	15			
K128	●	S16Q SDUCR 11	20	16	180	30	12,5	15			
K130	●	S20Q SDUCR 11	25	20	180	32	13	18			
K132	●	S25R SDUCR 11	32	25	200	40	17	23			
K134	●	S32T SDUCR 11	40	32	300	45	22	30			

## 93° SDUCL

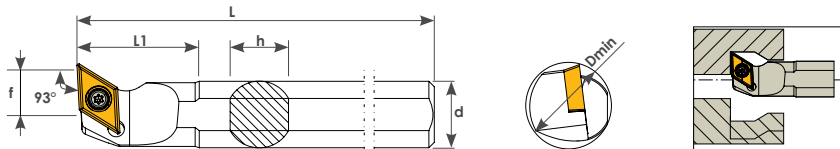

Sipariş Kodu Order Code Best.-Nr.	Stok/Stock/Lager	Ürün Kodu Product Code Produkt-Code	Ölçüler (mm) Dimensions (mm) Abmessungen (mm)						Kullanılan Uç Insert WSP	Sıkma Cıvatası Clamp Screw Torx-Schraube	Anahtar Torx Key Torx-Schlüssel
			Dmin	d	L	L1	f	h			
K250	●	S10J SDUCL 07	12	10	110	20	7	9	DC-- 0702	TC060 M2,5x5,5	T8
K252	●	S12K SDUCL 07	16	12	125	24	9	11			
K254	●	S14-16Q SDUCL 07	20	16	180	40	10,5	15			
K256	●	S16Q SDUCL 07	20	16	180	30	11	15			
K258	●	S16Q SDUCL 11	20	16	180	30	11	15	DC--11T3	TC067 M3,5x9	T15
K260	●	S20Q SDUCL 11	25	20	180	32	13	18			
K262	●	S25R SDUCL 11	32	25	200	40	17	23			
K263	●	S32T SDUCL 11	40	32	300	45	22	30			

● Stokta/ In Stock / Lager ○ Sınırlı Stok / Limited Stock / Begrenzte Lagerhaltung

## 107,5° SDQCR

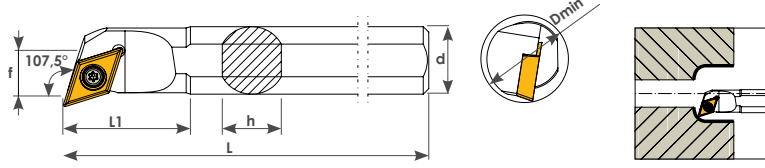

Sipariş Kodu Order Code Best.-Nr.	Stok/Stock/Lager	Ürün Kodu Product Code Produkt-Code	Ölçüler (mm) Dimensions(mm) Abmessungen (mm)						Kullanılan Uç Insert WSP	Sıkma Civatası Clamp Screw Torx-Schraube	Anahtar Torx Key Torx-Schlüssel
			Dmin	d	L	L1	f	h			
K140	●	S10J SDQCR 07	12	10	110	20	7	9	DC-- 0702	TC060 M2,5x5,5	T8
K142	●	S12K SDQCR 07	16	12	125	24	9	11			
K144	●	S16Q SDQCR 07	20	16	180	30	11	15			
K146	●	S16Q SDQCR 11	20	16	180	30	11	15	DC--11T3	TC067 M3,5x9	T15
K148	●	S20Q SDQCR 11	25	20	180	32	13	18			
K150	●	S25R SDQCR 11	32	25	200	40	17	23			
K152	●	S32T SDQCR 11	40	32	300	50	22	30			
K154	●	S40T SDQCR 11	49	40	300	50	27	38			

## 107,5° SDQCL

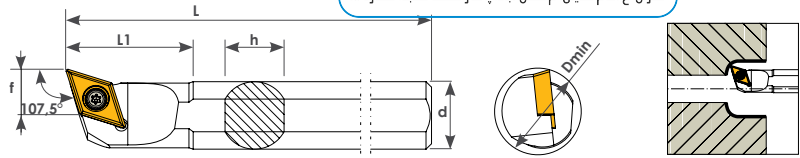

Sipariş Kodu Order Code Best.-Nr.	Stok/Stock/Lager	Ürün Kodu Product Code Produkt-Code	Ölçüler (mm) Dimensions(mm) Abmessungen (mm)						Kullanılan Uç Insert WSP	Sıkma Civatası Clamp Screw Torx-Schraube	Anahtar Torx Key Torx-Schlüssel
			Dmin	d	L	L1	f	h			
K270	●	S10J SDQCL 07	12	10	110	20	7	9	DC-- 0702	TC060 M2,5x5,5	T8
K272	●	S12K SDQCL 07	16	12	125	24	9	11			
K274	●	S16Q SDQCL 07	20	16	180	30	11	15			
K276	●	S16Q SDQCL 11	20	16	180	30	11	15	DC--11T3	TC067 M3,5x9	T15
K278	●	S20Q SDQCL 11	25	20	180	32	13	18			
K280	●	S25R SDQCL 11	32	25	200	40	17	23			
K281	●	S32T SDQCL 11	40	32	300	50	22	30			

● Stokta / In Stock / Lager ○ Sınırlı Stok / Limited Stock / Begrenzte Lagerhaltung

## 120° SDXCR



تکنیک تولز

ابزار آلات صنعتی، تراشکاری و ماشینکاری  
۶۶۷۱۱۷۲۹ - ۶۶۷۱۱۹۶۷

تهران، خ امام خمینی، م حسن آباد، پاساژ هشت گنبد، شماره ۱۵

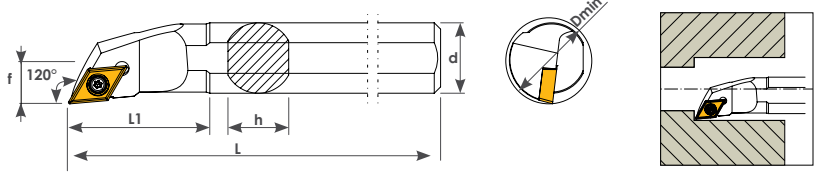

Sipariş Kodu Order Code Best.-Nr.	Stok/Stock/Lager	Ürün Kodu Product Code Produkt-Code	Ölçüler (mm) Dimensions(mm) Abmessungen (mm)						Kullanılan Uç Insert WSP	Sıkma Cıvatası Clamp Screw Torx-Schraube	Anahtar Torx Key Torx-Schlüssel
			Dmin	d	L	L1	f	h			
K469	●	S10J SDXCR 07	12	10	110	25	5.5	9	DC-- 0702	TC060 M2,5x5,5	T8
K470	●	S12K SDXCR 07	16	12	125	30	9	11			
K471	●	S16Q SDXCR 11	20	16	180	40	11	15	DC--11T3	TC067 M3,5x9	T15
K472	●	S20Q SDXCR 11	25	20	180	40	13	18			
K473	●	S25R SDXCR 11	32	25	200	40	17	23			
K474	●	S32T SDXCR 11	40	32	300	55	17	30			
K475	●	S40T SDXCR 11	49	40	300	55	21	38			

## 62,5° SD-CR

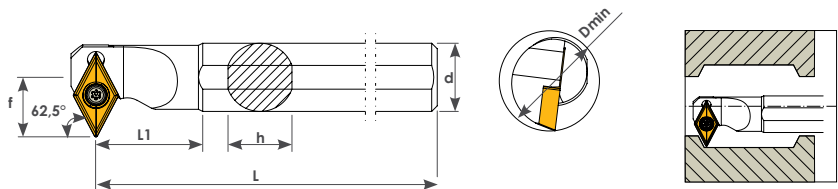

Sipariş Kodu Order Code Best.-Nr.	Stok/Stock/Lager	Ürün Kodu Product Code Produkt-Code	Ölçüler (mm) Dimensions(mm) Abmessungen (mm)						Kullanılan Uç Insert WSP	Sıkma Cıvatası Clamp Screw Torx-Schraube	Anahtar Torx Key Torx-Schlüssel
			Dmin	d	L	L1	f	h			
K168	●	S10J SD-CR 07	12	10	100	24	8.2	9	DC-- 0702	TC060 M2,5x5,5	T8
K170	●	S12K SD-CR 07	16	12	125	24	9	11			
K173	●	S16Q SD-CR 07	20	16	180	30	12	15	DC--11T3	TC067 M3,5x9	T15
K172	●	S16Q SD-CR 11	20	16	180	30	14	15			
K174	●	S20Q SD-CR 11	25	20	180	32	15	18			
K176	●	S25R SD-CR 11	32	25	200	45	17	23			
K178	●	S32T SD-CR 11	40	32	300	55	23	30			

● Stokta/ In Stock / Lager ○ Sınırlı Stok / Limited Stock / Begrenzte Lagerhaltung

## 5° SDZCR

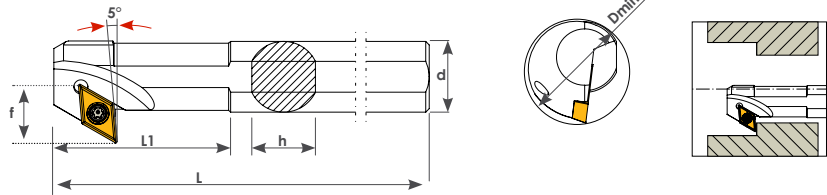
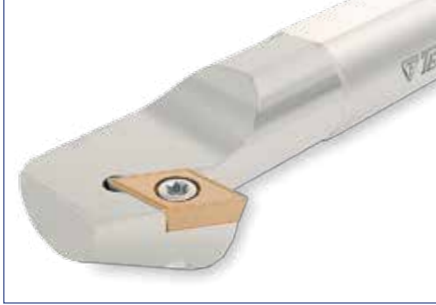

Sipariş Kodu Order Code Best.-Nr.	Stok/Stock/Lager	Ürün Kodu Product Code Produkt-Code	Ölçüler (mm) Dimensions (mm) Abmessungen (mm)						Kullanılan Uç Insert WSP	Sıkma Cıvatası Clamp Screw Torx-Schraube	Anahtar Torx Key Torx-Schlüssel
			Dmin	d	L	L1	f	h			
K190	●	S12K SDZCR 07	18	12	125	20	11	11	DC-- 0702	TC060 M2,5x5,5	T8
K192	●	S16Q SDZCR 11	23	16	180	25	14	15	DC--11T3	TC067 M3,5x9	T15
K194	●	S20Q SDZCR 11	30	20	180	30	19	18			
K196	●	S25R SDZCR 11	35	25	200	50	21	23			

## 60° ST-CR

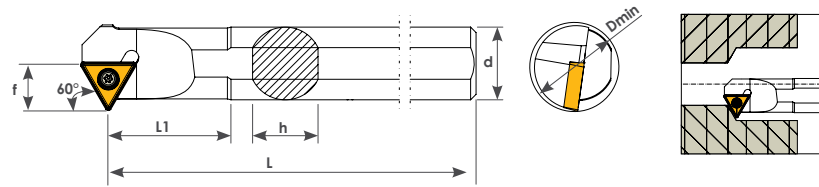

Sipariş Kodu Order Code Best.-Nr.	Stok/Stock/Lager	Ürün Kodu Product Code Produkt-Code	Ölçüler (mm) Dimensions (mm) Abmessungen (mm)						Kullanılan Uç Insert WSP	Sıkma Cıvatası Clamp Screw Torx-Schraube	Anahtar Torx Key Torx-Schlüssel
			Dmin	d	L	L1	f	h			
K180	●	S16Q ST-CR 16	20	16	180	40	11	15	TC--16T3	TC067 M3,5x9	T15
K182	●	S20Q ST-CR 16	25	20	180	40	13	18			
K183	●	S25R ST-CR 16	32	25	200	50	17	23			

● Stokta / In Stock / Lager ○ Sınırlı Stok / Limited Stock / Begrenzte Lagerhaltung

تکنیک تولز

ابزار آلات صنعتی، تراشکاری و قالبسازی

۶۶۷۱۱۲۲۹ - ۶۶۷۱۱۹۶۷

تهران، خ امام خمینی، م حسن آباد، پاساژ هشت گنبد، شماره ۱۵

## 90° STFCR

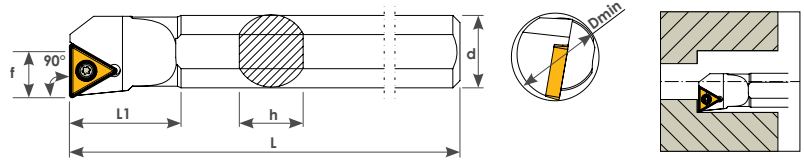

Sipariş Kodu Order Code Best.-Nr.	Stok/Stock/Lager	Ürün Kodu Product Code Produkt-Code	Ölçüler (mm) Dimensions (mm) Abmessungen (mm)						Kullanılan Uç Insert WSP	Sıkma Civatası Clamp Screw Torx-Schraube	Anahtar Torx Key Torx-Schlüssel
			Dmin	d	L	L1	f	h			
K160	●	S12K STFCR 11	16	12	125	24	9	11	TCMT 1102	TC060 M2,5x5,5	T8
K161	●	S16Q STFCR 11	20	16	180	30	11	15			
K162	●	S16Q STFCR 16	20	16	180	30	11	15	TCMT 16T3	TC067 M3,5x9	T15
K164	●	S20Q STFCR 16	25	20	180	30	13	18			
K166	●	S25R STFCR 16	32	25	200	37	16	23			

## 90° STFCL

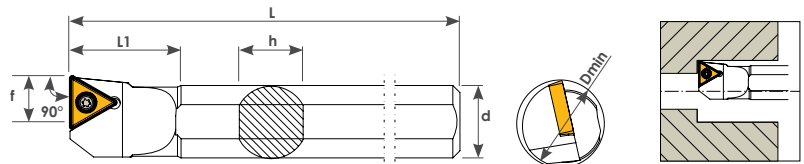
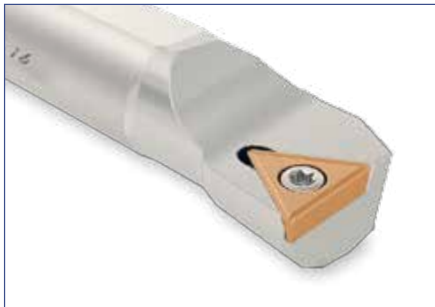

Sipariş Kodu Order Code Best.-Nr.	Stok/Stock/Lager	Ürün Kodu Product Code Produkt-Code	Ölçüler (mm) Dimensions (mm) Abmessungen (mm)						Kullanılan Uç Insert WSP	Sıkma Civatası Clamp Screw Torx-Schraube	Anahtar Torx Key Torx-Schlüssel
			Dmin	d	L	L1	f	h			
K184	●	S12K STFCL 11	16	12	125	24	9	11	TCMT 1102	TC060 M2,5x5,5	T8
K185	●	S16Q STFCL 11	20	16	180	30	11	15			
K186	●	S16Q STFCL 16	20	16	180	30	11	15	TCMT 16T3	TC067 M3,5x9	T15
K187	●	S20Q STFCL 16	25	20	180	30	13	18			
K188	●	S25R STFCL 16	32	25	200	37	16	23			

● Stokta / In Stock / Lager ○ Sınırlı Stok / Limited Stock / Begrenzte Lagerhaltung

## 93° SVUCR

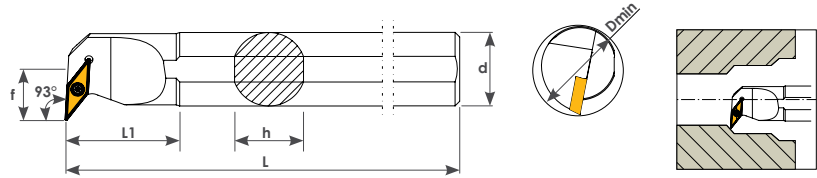

Sipariş Kodu Order Code Best.-Nr.	Stok/Stock/Lager	Ürün Kodu Product Code Produkt-Code	Ölçüler (mm) Dimensions (mm) Abmessungen (mm)						Kullanılan Uç Insert WSP	Sıkma Cıvatası Clamp Screw Torx-Schraube	Anahtar Torx Key Torx-Schlüssel
			Dmin	d	L	L1	f	h			
K211	●	S16Q SVUCR 11	20	16	180	30	11	15	VCMT 1103	TC060 M2,5x5,5	T8
K212	●	S20Q SVUCR 11	25	20	180	30	13	18			
K213	●	S25R SVUCR 16	32	25	200	40	17	23	VCMT 1604	TC074 M4x10	T15
K214	●	S32T SVUCR 16	40	32	300	50	22	30			

## 93° SVUCL

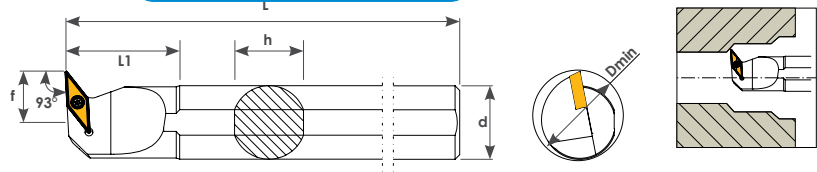
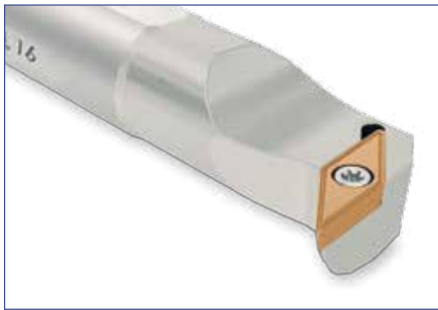

تکنیک تولز

ابزار آلات صنعتی، تراشکاری و ماشینکاری

۶۶۷۱۱۷۳۹ - ۶۶۷۱۱۹۶۶



تهران، خ امام خمینی، م حسن آباد، پاساژ هشت گنبد، شماره ۱۵

Sipariş Kodu Order Code Best.-Nr.	Stok/Stock/Lager	Ürün Kodu Product Code Produkt-Code	Ölçüler (mm) Dimensions (mm) Abmessungen (mm)						Kullanılan Uç Insert WSP	Sıkma Cıvatası Clamp Screw Torx-Schraube	Anahtar Torx Key Torx-Schlüssel
			Dmin	d	L	L1	f	h			
K300	●	S16Q SVUCL 11	20	16	180	30	11	15	VCMT 1103	TC060 M2,5x5,5	T8
K302	●	S20Q SVUCL 11	25	20	180	30	13	18			
K304	●	S25R SVUCL 16	32	25	200	40	17	23	VCMT 1604	TC074 M4x10	T15
K306	●	S32T SVUCL 16	40	32	300	50	22	30			

● Stokta/ In Stock / Lager ○ Sınırlı Stok / Limited Stock / Begrenzte Lagerhaltung

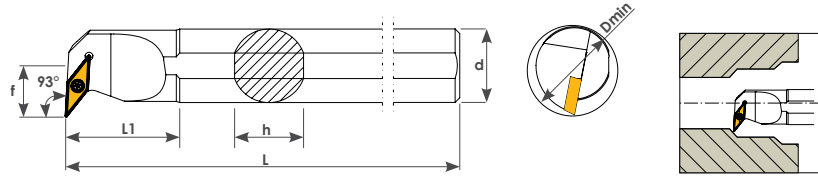
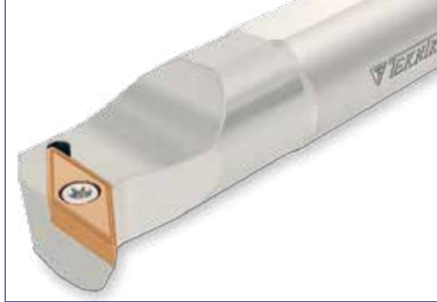
## 93° SVUBR



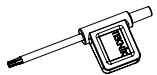

Sipariş Kodu Order Code Best.-Nr.	Stok/Stock/Lager	Ürün Kodu Product Code Produkt-Code	Ölçüler (mm) Dimensions (mm) Abmessungen (mm)						Kullanılan Uç Insert WSP	Sıkma Civatası Clamp Screw Torx-Schraube	Anahtar Torx Key Torx-Schlüssel
			Dmin	d	L	L1	f	h			
K206	●	S16Q SVUBR 11	20	16	180	30	11	15	VBMT 1103	TC060 M2,5x5,5	T8
K207	●	S20Q SVUBR 11	25	20	180	30	13	18			
K208	●	S25R SVUBR 16	32	25	200	50	17	23	VBMT 1604	TC074 M4x10	T15
K209	●	S32T SVUBR 16	40	32	300	50	22	30			
K210	●	S40T SVUBR 16	49	40	300	50	27	38			

● Stokta/ In Stock / Lager ○ Sınırlı Stok / Limited Stock / Begrenzte Lagerhaltung

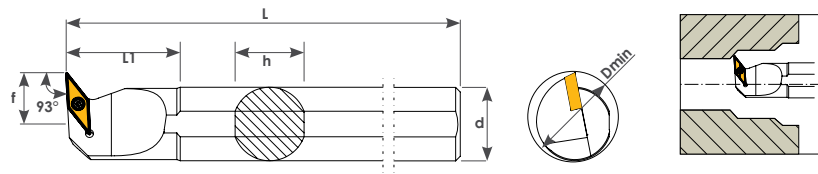

## 93° SVUBL



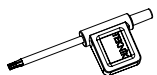

Sipariş Kodu Order Code Best.-Nr.	Stok/Stock/Lager	Ürün Kodu Product Code Produkt-Code	Ölçüler (mm) Dimensions (mm) Abmessungen (mm)						Kullanılan Uç Insert WSP	Sıkma Civatası Clamp Screw Torx-Schraube	Anahtar Torx Key Torx-Schlüssel
			Dmin	d	L	L1	f	h			
K282	●	S16Q SVUBL 11	20	16	180	30	11	15	VBMT 1103	TC060 M2,5x5,5	T8
K284	●	S20Q SVUBL 11	25	20	180	30	13	18			
K286	●	S25R SVUBL 16	32	25	200	50	17	23	VBMT 1604	TC074 M4x10	T15
K288	●	S32T SVUBL 16	40	32	300	50	22	30			

● Stokta/ In Stock / Lager ○ Sınırlı Stok / Limited Stock / Begrenzte Lagerhaltung

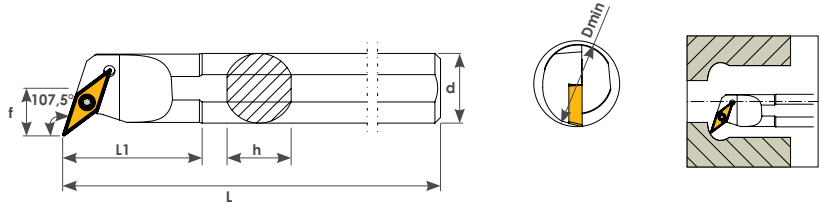

## 107,5° SVQBR

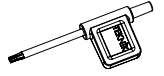

Sipariş Kodu Order Code Best.-Nr.	Stok/Stock/Lager	Ürün Kodu Product Code Produkt-Code	Ölçüler (mm) Dimensions(mm) Abmessungen (mm)						Kullanılan Uç Insert WSP	Sıkma Civatası Clamp Screw Torx-Schraube	Anahtar Torx Key Torx-Schlüssel
			Dmin	d	L	L1	f	h			
K216	●	S16Q SVQBR 11	20	16	180	30	11	15	VBMT 1103	TC060 M2,5x5,5	T8
K217	●	S20Q SVQBR 11	25	20	180	30	13	18			
K218	●	S25R SVQBR 16	32	25	200	40	17	23	VBMT 1604	TC074 M4x10	T15
K219	●	S32T SVQBR 16	40	32	300	50	22	30			
K220	●	S40T SVQBR 16	49	40	300	55	27	38			

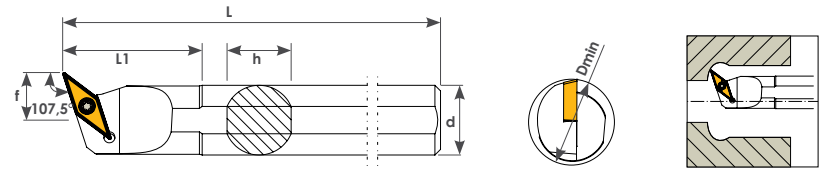
## 107,5° SVQBL



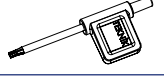

Sipariş Kodu Order Code Best.-Nr.	Stok/Stock/Lager	Ürün Kodu Product Code Produkt-Code	Ölçüler (mm) Dimensions(mm) Abmessungen (mm)						Kullanılan Uç Insert WSP	Sıkma Civatası Clamp Screw Torx-Schraube	Anahtar Torx Key Torx-Schlüssel
			Dmin	d	L	L1	f	h			
K310	●	S16Q SVQBL 11	20	16	180	30	11	15	VBMT 1103	TC060 M2,5x5,5	T8
K312	●	S20Q SVQBL 11	25	20	180	30	13	18			
K314	●	S25R SVQBL 16	32	25	200	40	17	23	VBMT 1604	TC074 M4x10	T15
K316	●	S32T SVQBL 16	40	32	300	50	22	30			
K318	●	S40T SVQBL 16	49	40	300	55	27	38			

● Stokta/ In Stock / Lager ○ Sınırlı Stok / Limited Stock / Begrenzte Lagerhaltung

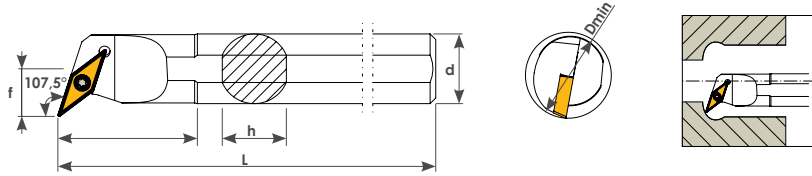

## 107,5° SVQCR



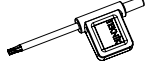

Sipariş Kodu Order Code Best.-Nr.	Stok/Stock/Lager	Ürün Kodu Product Code Produkt-Code	Ölçüler (mm) Dimensions (mm) Abmessungen (mm)						Kullanılan Uç Insert WSP	Sıkma Civatası Clamp Screw Torx-Schraube	Anahtar Torx Key Torx-Schlüssel
			Dmin	d	L	L1	f	h			
K221	●	S16Q SVQCR 11	20	16	180	30	11	15	VCMT 1103	TC060 M2,5x5,5	T8
K222	●	S20Q SVQCR 11	25	20	180	30	13	18			
K223	●	S25R SVQCR 16	32	25	200	50	17	23	VCMT 1604	TC074 M4x10	T15
K224	●	S32T SVQCR 16	40	32	300	50	22	30			
K225	●	S40T SVQCR 16	49	40	300	55	27	38			

● Stokta/ In Stock / Lager ○ Sınırlı Stok / Limited Stock / Begrenzte Lagerhaltung

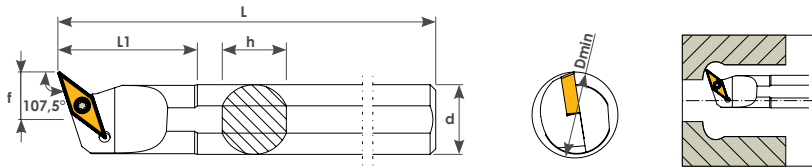
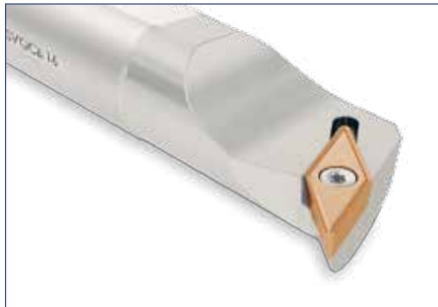

## 107,5° SVQCL

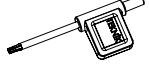

Sipariş Kodu Order Code Best.-Nr.	Stok/Stock/Lager	Ürün Kodu Product Code Produkt-Code	Ölçüler (mm) Dimensions (mm) Abmessungen (mm)						Kullanılan Uç Insert WSP	Sıkma Civatası Clamp Screw Torx-Schraube	Anahtar Torx Key Torx-Schlüssel
			Dmin	d	L	L1	f	h			
K319	●	S16Q SVQCL 11	20	16	180	30	11	15	VCMT 1103	TC060 M2,5x5,5	T8
K320	●	S20Q SVQCL 11	25	20	180	30	13	18			
K322	●	S25R SVQCL 16	32	25	200	40	17	23	VCMT 1604	TC074 M4x10	T15
K324	●	S32T SVQCL 16	40	32	300	50	22	30			

● Stokta/ In Stock / Lager ○ Sınırlı Stok / Limited Stock / Begrenzte Lagerhaltung



**İç Çap Kater Set**  
Boring Bars Set  
Bohrstange Set



SCLCR SET

Sipariş Kodu Order Code Best.-Nr.	Setteki Ürün Kodları Product Code In Set Produkt-Code in Set	Ölçüler (mm) Dimensions(mm) Abmessungen (mm)						Kullanılan Uç Insert WSP	Sıkma Civatası Clamp Screw Torx-Schraube	Anahtar Torx Key Torx-Schlüssel
		Dmin	d	L	L1	f	h			
İPS01	A08H SCLCR 06	10	8	100	17	5	7	CC-- 0602	TC060 M2,5x5,5	T8
	A10J SCLCR 06	12	10	110	20	6	9			
	A12K SCLCR 06	16	12	125	22	9	11			
	A16M SCLCR 09	20	16	150	30	11	15			

SCLCL SET

Sipariş Kodu Order Code Best.-Nr.	Setteki Ürün Kodları Product Code In Set Produkt-Code in Set	Ölçüler (mm) Dimensions(mm) Abmessungen (mm)						Kullanılan Uç Insert WSP	Sıkma Civatası Clamp Screw Torx-Schraube	Anahtar Torx Key Torx-Schlüssel
		Dmin	d	L	L1	f	h			
İPS04	A08H SCLCL 06	10	8	100	17	5	7	CC-- 0602	TC060 M2,5x5,5	T8
	A10J SCLCL 06	12	10	110	20	6	9			
	A12K SCLCL 06	16	12	125	22	9	11			
	A16M SCLCL 09	20	16	150	30	11	15			

SDUCR SET

Sipariş Kodu Order Code Best.-Nr.	Setteki Ürün Kodları Product Code In Set Produkt-Code in Set	Ölçüler (mm) Dimensions(mm) Abmessungen (mm)						Kullanılan Uç Insert WSP	Sıkma Civatası Clamp Screw Torx-Schraube	Anahtar Torx Key Torx-Schlüssel
		Dmin	d	L	L1	f	h			
İPS02	A10J SDUCR 07	12	10	110	20	7	9	DC--0702	TC060 M2,5x5,5	T8
	A12K SDUCR 07	16	12	125	24	9	11			
	A16M SDUCR 07	20	16	150	30	11	15			

SDUCL SET

Sipariş Kodu Order Code Best.-Nr.	Setteki Ürün Kodları Product Code In Set Produkt-Code in Set	Ölçüler (mm) Dimensions(mm) Abmessungen (mm)						Kullanılan Uç Insert WSP	Sıkma Civatası Clamp Screw Torx-Schraube	Anahtar Torx Key Torx-Schlüssel
		Dmin	d	L	L1	f	h			
İPS05	A10J SDUCL 07	12	10	110	20	7	9	DC--0702	TC060 M2,5x5,5	T8
	A12K SDUCL 07	16	12	125	24	9	11			
	A16M SDUCL 07	20	16	150	30	11	15			



SDQCR SET

Sipariş Kodu Order Code Best.-Nr.	Setteki Ürün Kodları Product Code In Set Produkt-Code in Set	Ölçüler (mm) Dimensions(mm) Abmessungen (mm)						Kullanılan Uç Insert WSP	Sıkma Civatası Clamp Screw Torx-Schraube	Anahtar Torx Key Torx-Schlüssel
		Dmin	d	L	L1	f	h			
İPS03	A10J SDQCR 07	12	10	110	18	7	9	DC--0702	TC060 M2,5x5,5	T8
	A12K SDQCR 07	16	12	125	22	9	11			
	A16M SDQCR 07	20	16	150	30	11	15			



SDQCL SET

Sipariş Kodu Order Code Best.-Nr.	Setteki Ürün Kodları Product Code In Set Produkt-Code in Set	Ölçüler (mm) Dimensions(mm) Abmessungen (mm)						Kullanılan Uç Insert WSP	Sıkma Civatası Clamp Screw Torx-Schraube	Anahtar Torx Key Torx-Schlüssel
		Dmin	d	L	L1	f	h			
İPS06	A10J SDQCL 07	12	10	110	18	7	9	DC--0702	TC060 M2,5x5,5	T8
	A12K SDQCL 07	16	12	125	22	9	11			
	A16M SDQCL 07	20	16	150	30	11	15			



SCLCR SET

Sipariş Kodu Order Code Best.-Nr.	Setteki Ürün Kodları Product Code In Set Produkt-Code in Set	Ölçüler (mm) Dimensions(mm) Abmessungen (mm)						Kullanılan Uç Insert WSP	Sıkma Cıvatası Clamp Screw Torx-Schraube	Anahtar Torx Key Torx-Schlüssel
		Dmin	d	L	L1	f	h			
İPS20	S08H SCLCR 06	10	8	100	17	5	7			
	S10J SCLCR 06	12	10	110	20	6	9			
	S12K SCLCR 06	16	12	125	22	9	11			
	S16M SCLCR 09	20	16	150	30	11	15			
								CC-- 0602	TC060 M2,5x5,5	T8
								CC-- 09T3	TC067 M3,5x9	T15

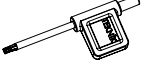

SCLCL SET

Sipariş Kodu Order Code Best.-Nr.	Setteki Ürün Kodları Product Code In Set Produkt-Code in Set	Ölçüler (mm) Dimensions(mm) Abmessungen (mm)						Kullanılan Uç Insert WSP	Sıkma Cıvatası Clamp Screw Torx-Schraube	Anahtar Torx Key Torx-Schlüssel
		Dmin	d	L	L1	f	h			
İPS21	S08H SCLCL 06	10	8	100	17	5	7			
	S10J SCLCL 06	12	10	110	20	6	9			
	S12K SCLCL 06	16	12	125	22	9	11			
	S16M SCLCL 09	20	16	150	30	11	15			
								CC-- 0602	TC060 M2,5x5,5	T8
								CC-- 09T3	TC067 M3,5x9	T15



SDUCR SET

Sipariş Kodu Order Code Best.-Nr.	Setteki Ürün Kodları Product Code In Set Produkt-Code in Set	Ölçüler (mm) Dimensions(mm) Abmessungen (mm)						Kullanılan Uç Insert WSP	Sıkma Cıvatası Clamp Screw Torx-Schraube	Anahtar Torx Key Torx-Schlüssel
		Dmin	d	L	L1	f	h			
İPS22	S10J SDUCR 07	12	10	110	20	7	9			
	S12K SDUCR 07	16	12	125	24	9	11			
	S16M SDUCR 11	20	16	150	30	11	15			
								DC--0702	TC060 M2,5x5,5	T8
								DC--11T3	TC067 M3,5x9	T15

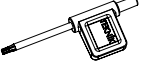

SDUCL SET

Sipariş Kodu Order Code Best.-Nr.	Setteki Ürün Kodları Product Code In Set Produkt-Code in Set	Ölçüler (mm) Dimensions(mm) Abmessungen (mm)						Kullanılan Uç Insert WSP	Sıkma Cıvatası Clamp Screw Torx-Schraube	Anahtar Torx Key Torx-Schlüssel
		Dmin	d	L	L1	f	h			
İPS23	S10J SDUCL 07	12	10	110	20	7	9			
	S12K SDUCL 07	16	12	125	24	9	11			
	S16M SDUCL 11	20	16	150	30	11	15			
								DC--0702	TC060 M2,5x5,5	T8
								DC--11T3	TC067 M3,5x9	T15

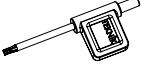
SDQCR SET

Sipariş Kodu Order Code Best.-Nr.	Setteki Ürün Kodları Product Code In Set Produkt-Code in Set	Ölçüler (mm) Dimensions(mm) Abmessungen (mm)						Kullanılan Uç Insert WSP	Sıkma Cıvatası Clamp Screw Torx-Schraube	Anahtar Torx Key Torx-Schlüssel
		Dmin	d	L	L1	f	h			
İPS24	S10J SDQCR 07	12	10	110	18	7	9			
	S12K SDQCR 07	16	12	125	22	9	11			
	S16M SDQCR 11	20	16	150	30	11	15			
								DC--0702	TC060 M2,5x5,5	T8
								DC--11T3	TC067 M3,5x9	T15

SDQCL SET

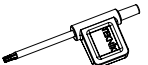
Sipariş Kodu Order Code Best.-Nr.	Setteki Ürün Kodları Product Code In Set Produkt-Code in Set	Ölçüler (mm) Dimensions(mm) Abmessungen (mm)						Kullanılan Uç Insert WSP	Sıkma Cıvatası Clamp Screw Torx-Schraube	Anahtar Torx Key Torx-Schlüssel
		Dmin	d	L	L1	f	h			
İPS25	S10J SDQCL 07	12	10	110	18	7	9			
	S12K SDQCL 07	16	12	125	22	9	11			
	S16M SDQCL 11	20	16	150	30	11	15			
								DC--0702	TC060 M2,5x5,5	T8
								DC--11T3	TC067 M3,5x9	T15



**İç Çap Kater İçten Soğutmalı**  
Boring Bars (Cooled)  
Bohrstange  
(Mit Innenkühlung)

**تکنیک تولز**

ابزار آلات صنعتی، تراشکاری و ماشینکاری

۶۶۷۱۱۷۲۹ - ۶۶۷۱۱۹۶۷

تهران، خ امام خمینی، م حسن آباد، پاساژ هشت گنبد، شماره ۱۵



[www.teknikcuttingtools.com](http://www.teknikcuttingtools.com)

## 95° SCLCR IK

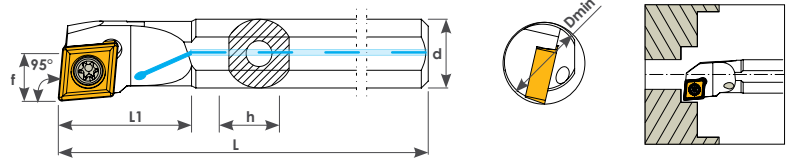

Sipariş Kodu Order Code Best.-Nr.	Stok/Stock/Lager	Ürün Kodu Product Code	Ölçüler (mm) Dimensions (mm) Abmessungen (mm)							Kullanılan Uç Insert WSP	Sıkma Cıvatası Clamp Screw Torx-Schraube	Anahtar Torx Key Torx-Schlüssel
			Dmin	d	L	L1	f	h				
KA102	●	A08H SCLCR 06	10	8	100	17	5,5	7	CC-- 0602	TC060 M2,5x5,5	T8	
KA104	●	A10J SCLCR 06	12	10	110	20	6	9				
KA106	●	A12K SCLCR 06	16	12	125	24	9	11				
KA108	●	A14-16Q SCLCR 09	20	16	180	45	10	15	CC-- 09T3	TC067 M3,5x9	T15	
KA110	●	A16Q SCLCR 09	20	16	180	30	11	15				
KA111	●	A16M SCLCR 09	20	16	150	30	11	15				
KA114	●	A20Q SCLCR 09	25	20	180	38	13	18				
KA116	●	A25R SCLCR 09	32	25	200	40	17	23				

## 95° SCLCL IK

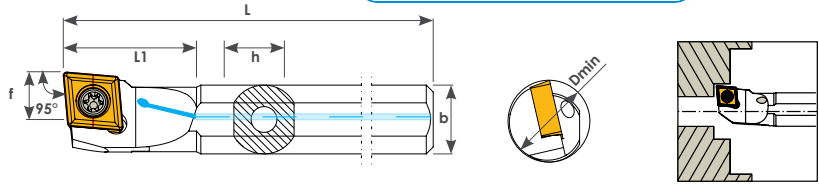

Sipariş Kodu Order Code Best.-Nr.	Stok/Stock/Lager	Ürün Kodu Product Code Produkt-Code	Ölçüler (mm) Dimensions (mm) Abmessungen (mm)							Kullanılan Uç Insert WSP	Sıkma Cıvatası Clamp Screw Torx-Schraube	Anahtar Torx Key Torx-Schlüssel
			Dmin	d	L	L1	f	h				
KA232	●	A08H SCLCL 06	10	8	100	17	5,5	7	CC-- 0602	TC060 M2,5x5,5	T8	
KA234	●	A10J SCLCL 06	12	10	110	20	6	9				
KA236	●	A12K SCLCL 06	16	12	125	23	9	11				
KA239	●	A16M SCLCL 09	20	16	150	30	11	15	CC-- 09T3	TC067 M3,5x9	T15	
KA240	●	A16Q SCLCL 09	20	16	180	30	11	15				
KA244	●	A20Q SCLCL 09	25	20	180	38	13	18				
KA246	●	A25R SCLCL 09	32	25	200	40	17	23				

● Stokta/ In Stock / Lager ○ Sınırlı Stok / Limited Stock / Begrenzte Lagerhaltung

## 90° STFCR IK

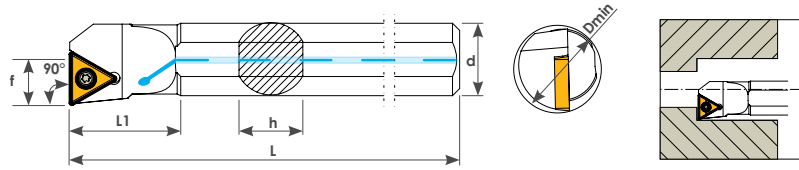

Sipariş Kodu Order Code Best.-Nr.	Stok/Stock/Lager	Ürün Kodu Product Code Produkt-Code	Ölçüler (mm) Dimensions (mm) Abmessungen (mm)						Kullanılan Uç Insert WSP	Sıkma Civatası Clamp Screw Torx-Schraube	Anahtar Torx Key Torx-Schlüssel
			Dmin	d	L	L1	f	h			
KA160	●	A12K STFCR 11	16	12	125	24	9	11	TCMT 1102	TC060 M2,5x5,5	T8
KA161	●	A16Q STFCR 11	20	16	180	30	11	15			
KA162	●	A16Q STFCR 16	20	16	180	30	11	15			
KA164	●	A20Q STFCR 16	25	20	180	30	13	18	TCMT 16T3	TC067 M3,5x9	T15
KA166	●	A25R STFCR 16	32	25	200	37	16	23			

## 90° STFCL IK

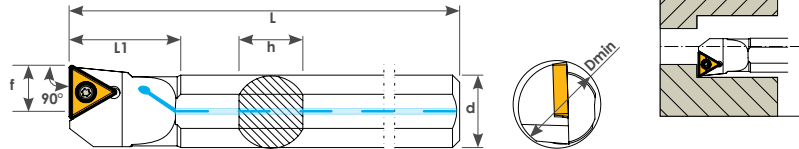

Sipariş Kodu Order Code Best.-Nr.	Stok/Stock/Lager	Ürün Kodu Product Code Produkt-Code	Ölçüler (mm) Dimensions (mm) Abmessungen (mm)						Kullanılan Uç Insert WSP	Sıkma Civatası Clamp Screw Torx-Schraube	Anahtar Torx Key Torx-Schlüssel
			Dmin	d	L	L1	f	h			
KA184	●	A12K STFCL 11	16	12	125	24	9	11	TCMT 1102	TC060 M2,5x5,5	T8
KA185	●	A16Q STFCL 11	20	16	180	30	11	15			
KA186	●	A16Q STFCL 16	20	16	180	30	11	15			
KA187	●	A20Q STFCL 16	25	20	180	30	13	18	TCMT 16T3	TC067 M3,5x9	T15
KA188	●	A25R STFCL 16	32	25	200	37	16	23			

● Stokta / In Stock / Lager ○ Sınırlı Stok / Limited Stock / Begrenzte Lagerhaltung

## 93° SDUCR IK

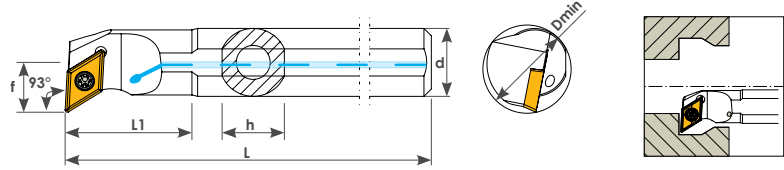

Sipariş Kodu Order Code Best.-Nr.	Stok/Stock/Lager	Ürün Kodu Product Code Produkt-Code	Ölçüler (mm) Dimensions (mm) Abmessungen (mm)						Kullanılan Uç Insert WSP	Sıkma Cıvatası Clamp Screw Torx-Schraube	Anahtar Torx Key Torx-Schlüssel
			Dmin	d	L	L1	f	h			
KA120	●	A10J SDUCR 07	12	10	110	20	7	9	DC--0702	TC060 M2,5x5,5	T8
KA122	●	A12K SDUCR 07	16	12	125	24	9	11			
KA124	●	A14-16Q SDUCR 07	20	16	180	40	10,5	15			
KA126	●	A16Q SDUCR 07	20	16	180	30	11	15			
KA127	●	A16M SDUCR 07	20	16	150	30	11	15			
KA128	●	A16Q SDUCR 11	20	16	180	30	11	15	DC--11T3	TC067 M3,5x9	T15
KA129	●	A16M SDUCR 11	20	16	150	30	11	15			
KA130	●	A20Q SDUCR 11	25	20	180	32	13	18			
KA132	●	A25R SDUCR 11	32	25	200	40	17	23			
KA134	●	A32T SDUCR 11	40	32	300	45	22	30			

## 93° SDUCL IK

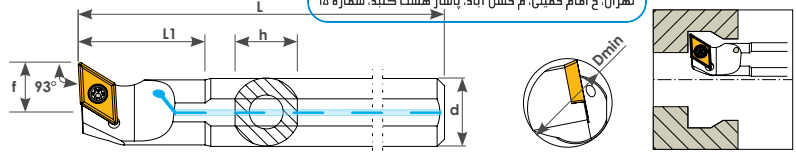

Sipariş Kodu Order Code Best.-Nr.	Stok/Stock/Lager	Ürün Kodu Product Code Produkt-Code	Ölçüler (mm) Dimensions (mm) Abmessungen (mm)						Kullanılan Uç Insert WSP	Sıkma Cıvatası Clamp Screw Torx-Schraube	Anahtar Torx Key Torx-Schlüssel
			Dmin	d	L	L1	f	h			
KA250	●	A10J SDUCL 07	12	10	110	20	7	9	DC--0702	TC060 M2,5x5,5	T8
KA252	●	A12K SDUCL 07	16	12	125	23	9	11			
KA254	●	A14-16Q SDUCL 07	20	16	180	40	10,5	15			
KA256	●	A16Q SDUCL 07	20	16	180	30	11	15			
KA258	●	A16Q SDUCL 11	20	16	180	30	11	15			
KA259	●	A16M SDUCL 11	20	16	150	30	11	15	DC--11T3	TC067 M3,5x9	T15
KA260	●	A20Q SDUCL 11	25	20	180	32	13	18			
KA262	●	A25R SDUCL 11	32	25	200	40	17	23			

● Stokta / In Stock / Lager ○ Sınırlı Stok / Limited Stock / Begrenzte Lagerhaltung



## 107,5° SDQCR IK

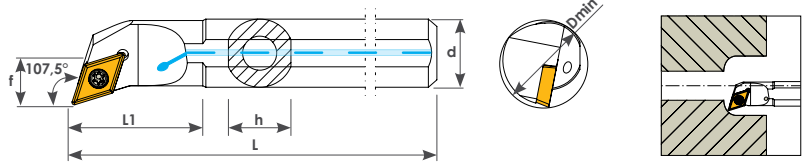

Sipariş Kodu Order Code Best.-Nr.	Stok/Stock/Lager	Ürün Kodu Product Code Produkt-Code	Ölçüler (mm) Dimensions (mm) Abmessungen (mm)						Kullanılan Uç Insert WSP	Sıkma Civatası Clamp Screw Torx-Schraube	Anahtar Torx Key Torx-Schlüssel
			Dmin	d	L	L1	f	h			
KA140	●	A10J SDQCR 07	12	10	100	18	7	9	DC--0702	TC060 M2,5x5,5	T8
KA142	●	A12K SDQCR 07	16	12	125	22	9	11			
KA143	●	A16M SDQCR 07	20	16	150	30	11	15			
KA144	●	A16Q SDQCR 07	20	16	180	32	11	15			
KA146	●	A16Q SDQCR 11	20	16	180	32	11	15	DC--11T3	TC067 M3,5x9	T15
KA148	●	A20Q SDQCR 11	25	20	180	32	13	18			
KA150	●	A25R SDQCR 11	32	25	200	40	17	23			

## 107,5° SDQCL IK

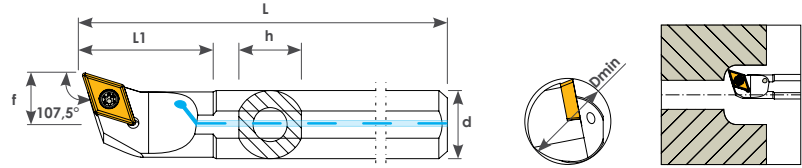

Sipariş Kodu Order Code Best.-Nr.	Stok/Stock/Lager	Ürün Kodu Product Code Produkt-Code	Ölçüler (mm) Dimensions (mm) Abmessungen (mm)						Kullanılan Uç Insert WSP	Sıkma Civatası Clamp Screw Torx-Schraube	Anahtar Torx Key Torx-Schlüssel
			Dmin	d	L	L1	f	h			
KA270	●	A10J SDQCL 07	12	10	110	18	7	9	DC--0702	TC060 M2,5x5,5	T8
KA272	●	A12K SDQCL 07	16	12	125	22	9	11			
KA273	●	A16M SDQCL 07	20	16	150	30	11	15			
KA274	●	A16Q SDQCL 07	20	16	180	32	11	15			
KA276	●	A16Q SDQCL 11	20	16	180	32	11	15	DC--11T3	TC067 M3,5x9	T15
KA278	●	A20Q SDQCL 11	25	20	180	32	13	18			
KA280	●	A25R SDQCL 11	32	25	200	46	17	23			

● Stokta/ In Stock / Lager ○ Sınırlı Stok / Limited Stock / Begrenzte Lagerhaltung

## 93° SVUCR IK

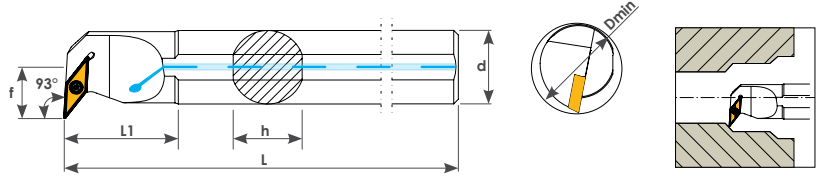

Sipariş Kodu Order Code Best.-Nr.	Stok/Stock/Lager	Ürün Kodu Product Code Produkt-Code	Ölçüler (mm) Dimensions(mm) Abmessungen (mm)						Kullanılan Uç Insert WSP	Sıkma Cıvatası Clamp Screw Torx-Schraube	Anahtar Torx Key Torx-Schlüssel
			Dmin	d	L	L1	f	h			
KA211	●	A16Q SVUCR 11	20	16	180	30	11	15	VCMT 1103	TC060 M2,5x5,5	T8
KA212	●	A20Q SVUCR 11	25	20	180	30	13	18			
KA213	●	A25R SVUCR 16	32	25	200	40	17	23	VCMT 1604	TC074 M4x10	T15
KA214	●	A32T SVUCR 16	40	32	300	50	22	30			

## 93° SVUCL IK

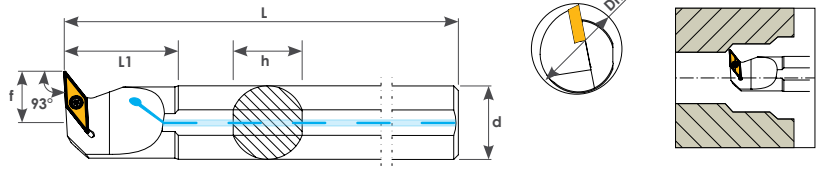



Sipariş Kodu Order Code Best.-Nr.	Stok/Stock/Lager	Ürün Kodu Product Code Produkt-Code	Ölçüler (mm) Dimensions(mm) Abmessungen (mm)						Kullanılan Uç Insert WSP	Sıkma Cıvatası Clamp Screw Torx-Schraube	Anahtar Torx Key Torx-Schlüssel
			Dmin	d	L	L1	f	h			
KA300	●	A16Q SVUCL 11	20	16	180	30	11	15	VCMT 1103	TC060 M2,5x5,5	T8
KA302	●	A20Q SVUCL 11	25	20	180	30	13	18			
KA304	●	A25R SVUCL 16	32	25	200	40	17	23	VCMT 1604	TC074 M4x10	T15
KA306	●	A32T SVUCL 16	40	32	300	50	22	30			

● Stokta/ In Stock / Lager ○ Sınırlı Stok / Limited Stock / Begrenzte Lagerhaltung

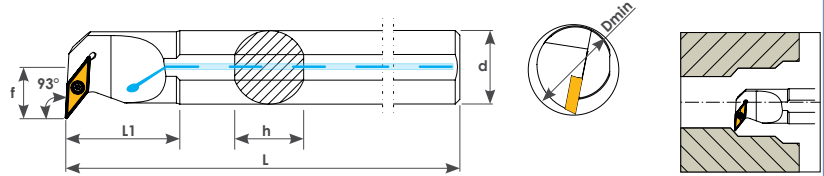
## 93° SVUBR IK



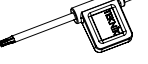

Sipariş Kodu Order Code Best.-Nr.	Stok/Stock/Lager	Ürün Kodu Product Code Produkt-Code	Ölçüler (mm) Dimensions (mm) Abmessungen (mm)						Kullanılan Uç Insert WSP	Sıkma Cıvatası Clamp Screw Torx-Schraube	Anahtar Torx Key Torx-Schlüssel
			Dmin	d	L	L1	f	h			
KA208	●	A25R SVUBR 16	32	25	200	40	17	23	VBMT 1604	TC074 M4x10	T15
KA209	●	A32T SVUBR 16	40	32	300	50	22	30			

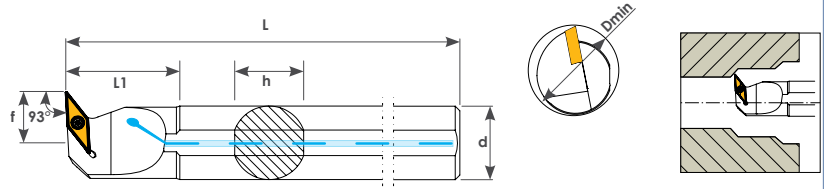

## 93° SVUBL IK

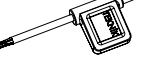

Sipariş Kodu Order Code Best.-Nr.	Stok/Stock/Lager	Ürün Kodu Product Code Produkt-Code	Ölçüler (mm) Dimensions (mm) Abmessungen (mm)						Kullanılan Uç Insert WSP	Sıkma Cıvatası Clamp Screw Torx-Schraube	Anahtar Torx Key Torx-Schlüssel
			Dmin	d	L	L1	f	h			
KA286	●	A25R SVUBL 16	32	25	200	40	17	23	VBMT 1604	TC074 M4x10	T15
KA288	●	A32T SVUBL 16	40	32	300	50	22	30			

● Stokta / In Stock / Lager ○ Sınırlı Stok / Limited Stock / Begrenzte Lagerhaltung

## 107,5° SVQCR IK

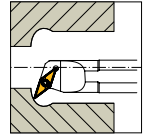
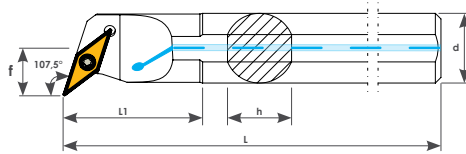

Sipariş Kodu Order Code Best.-Nr.	Stok/Stock/Lager	Ürün Kodu Product Code Produkt-Code	Ölçüler (mm) Dimensions (mm) Abmessungen (mm)						Kullanılan Uç Insert WSP	Sıkma Civatası Clamp Screw Torx-Schraube	Anahtar Torx Key Torx-Schlüssel
			Dmin	d	L	L1	f	h			
KA221	●	A16Q SVQCR 11	20	16	180	30	11	15	VBMT 1103	TC060 M2,5x5,5	T8
KA222	●	A20Q SVQCR 11	25	20	180	30	13	18			

● Stokta / In Stock / Lager ○ Sınırlı Stok / Limited Stock / Begrenzte Lagerhaltung





**تکنیک تولز**

ابزار آلات صنعتی ، تراشکاری و ماشینکاری

۱۶۷۱۱۷۳۹ - ۱۶۷۱۱۹۶۷

تهران، خ امام خمینی، م حسن آباد، پاساژ هشت گنبد، شماره ۱۵

**U-Drill**

Indexable Inset Drills  
Vollbohrer



**U-DRİLL EKSANTRİK ADAPTÖRÜ**  
ADAPTOR FOR U-DRILLS

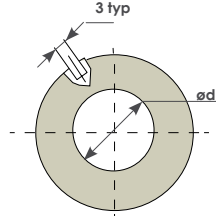
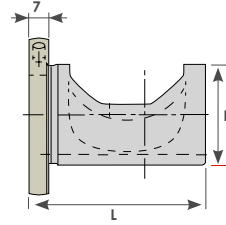

Adaptörün radyal olarak ayarlanmasını kolaylaştırmak için kullanılır.  
(This pin used to ease radial adjustment of the sleeve.)

Sipariş Kodu Order Code Best.-Nr.	Stok/Stock/Lager	Ürün Kodu Product Code Produkt-Code	Ölçüler (mm) Dimensions (mm) Abmessungen (mm)		
			D	d	L
UA 10	●	D25 d20 L46	25	20	46,5
UA 12	●	D32 d25 L47	32	25	47
UA 14	●	D40 d32 L57	40	32	57

● Stokta / In Stock / Lager ○ Sınırlı Stok / Limited Stock / Begrenzte Lagerhaltung

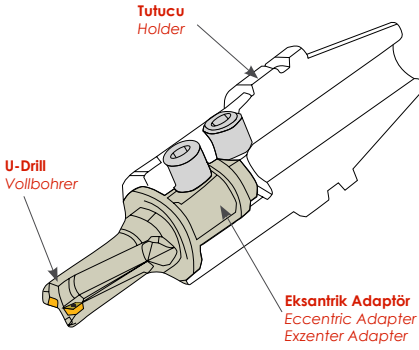

Frezeleme tezgahında takma uçlu matkabın nominal çapı, matkabın ekseninin, sipindile eksenine göre ötelenmesiyle değişebilir.  
On a milling machine the drill's nominal diameter can be changed by shifting the drill's axis out of the tool spindle.

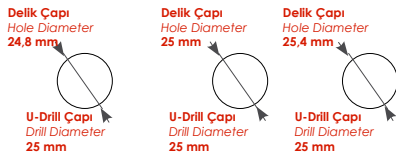
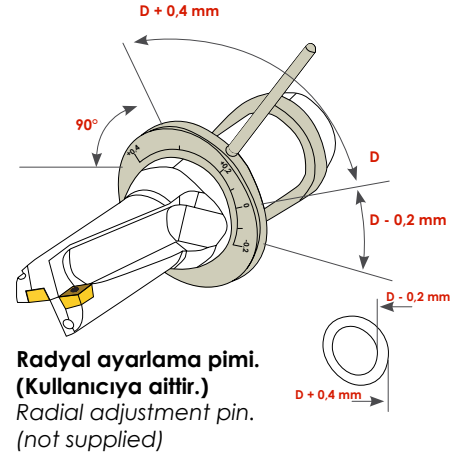
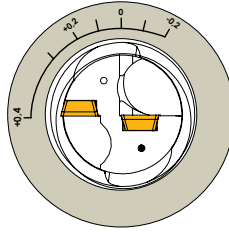



U-Drill'in üzerindeki düz çizgi adaptörün sıfır rakamının üzerine konulmalıdır.  
AET'nin (eksantrik adaptörün) çevrilmesini kolaylaştırmak için AET'nin üzerindeki deliğe, metal bir çubuk ya da vida anahtarını yerleştirilebilir. AET'yi ayarlamadan önce tutucunun vidasını hafifçe çözün.

The adjustment marking should be located perpendicular to the flat on the circumference of the U-DRILL flange.  
To facilitate the rotation of the adaptor, a metal rod or a screw key may be inserted into a hole on the exentric adaptor flange. Unlock adaptor screw before adjusting adaptor.

U9  
D2 WCMX

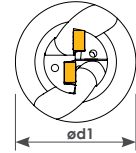
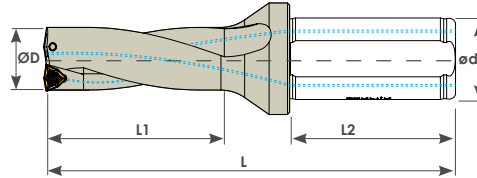
تکنیک تولز  
ابزار آلات صنعتی، تراشکاری و قالبسازی  
۶۶۷۱۱۷۲۹ - ۶۶۷۱۱۹۶۷  
تهران، خ امام خمینی، م حسن آباد، پاساژ هشت گنبد، شماره ۱۵

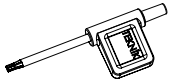

Sipariş Kodu Order Code Best.-Nr.	Stok/Stock/Lager	Ürün Kodu Product Code Produkt-Code	Ölçüler (mm) Dimensions (mm) Abmessungen (mm)						Kullanılan Uç Insert WSP	Sıkma Civatası Clamp Screw Torx-Schraube	Anahtar Torx Key Torx-Schlüssel
			ØD	ød	d1	L	L1	L2			
U104	●	D2 16 WCMX 03	16	25	34	108	32	56	WCMX 0302 KRLY	TC060 M2,5x5,5	T8
U105	●	D2 17 WCMX 03	17	25	34	110	34	56			
U106	●	D2 18 WCMX 03	18	25	34	113	36	56			
U107	●	D2 19 WCMX 03	19	25	34	115	38	56			
U108	●	D2 20 WCMX 04	20	25	34	119	40	56	WCMX 0402 KRLY	TC065 M3x7	T8
U110	●	D2 21 WCMX 04	21	25	34	121	42	56			
U112	●	D2 22 WCMX 04	22	25	34	123	44	56			
U114	●	D2 23 WCMX 04	23	25	34	127	46	56			
U116	●	D2 24 WCMX 05	24	25	34	130	48	56	WCMX 0503 KRLY	TC067 M3,5x9	T15
U118	●	D2 25 WCMX 05	25	25	34	133	50	56			
U120	●	D2 26 WCMX 05	26	25	34	135	52	56			
U122	●	D2 27 WCMX 05	27	25	34	137	54	56			
U124	●	D2 28 WCMX 05	28	25	34	140	56	56	WCMX 06T3 KRLY	TC067 M3,5x9	T15
U126	●	D2 29 WCMX 05	29	25	34	142	58	56			
U128	●	D2 30 WCMX 06	30	32	44	151	60	58			
U130	●	D2 31 WCMX 06	31	32	44	154	62	58			
U132	●	D2 32 WCMX 06	32	32	44	156	64	58			
U134	●	D2 33 WCMX 06	33	32	44	159	66	58			
U136	●	D2 34 WCMX 06	34	32	44	161	68	58			
U137	●	D2 35 WCMX 06	35	32	44	164	70	58			
U138	●	D2 36 WCMX 06	36	32	44	167	72	58			
U139	●	D2 37 WCMX 06	37	32	44	170	74	58			
U140	●	D2 38 WCMX 06	38	32	44	173	76	58			
U141	●	D2 39 WCMX 06	39	32	44	175	78	58			
U142	●	D2 40 WCMX 06	40	32	44	178	80	58			

● Stokta / In Stock / Lager ○ Sınırlı Stok / Limited Stock / Begrenzte Lagerhaltung  
KRLY ucuna uygundur. / Compatible with KRLY insert. / Kompatible für KRLY WP

U9  
D3 WCMX

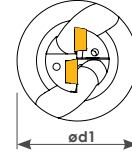
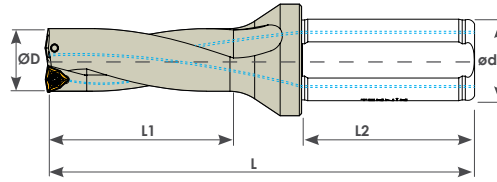



Sipariş Kodu Order Code Best.-Nr.	Stok/Stock/Lager	Ürün Kodu Product Code Produkt-Code	Ölçüler (mm) Dimensions (mm) Abmessungen (mm)						Kullanılan Uç Insert WSP	Sıkma Cıvatası Clamp Screw Torx-Schraube	Anahtar Torx Key Torx-Schlüssel
			ØD	ød	d1	L	L1	L2			
U143	●	D3 16 WCMX 03	16	25	34	124	48	56	WCMX 0302 KRLY	TC060 M2,5x5,5	
U143-1	●	D3 16,5 WCMX 03	16,5	25	34	124	48	56			
U144	●	D3 17 WCMX 03	17	25	34	127	51	56			
U145	●	D3 17,5 WCMX 03	17,5	25	34	127	51	56			
U146	●	D3 18 WCMX 03	18	25	34	131	54	56			
U147	●	D3 18,5 WCMX 03	18,5	25	34	131	54	56			
U148	●	D3 19 WCMX 03	19	25	34	134	57	56			
U149	●	D3 19,5 WCMX 03	19,5	25	34	134	57	56			
U150	●	D3 20 WCMX 04	20	25	34	139	60	56			
U151	●	D3 20,5 WCMX 04	20,5	25	34	139	60	56			
U152	●	D3 21 WCMX 04	21	25	34	142	63	56	WCMX 0402 KRLY	TC065 M3x7	T8
U153	●	D3 21,5 WCMX 04	21,5	25	34	142	63	56			
U154	●	D3 22 WCMX 04	22	25	34	145	66	56			
U155	●	D3 22,5 WCMX 04	22,5	25	34	145	66	56			
U156	●	D3 23 WCMX 04	23	25	34	150	69	56			
U157	●	D3 23,5 WCMX 04	23,5	25	34	150	69	56			
U158	●	D3 24 WCMX 05	24	25	34	154	72	56			
U159	●	D3 24,5 WCMX 05	24,5	25	34	154	72	56			
U160	●	D3 25 WCMX 05	25	25	34	158	75	56			
U161	●	D3 25,5 WCMX 05	25,5	25	34	158	75	56			
U162	●	D3 26 WCMX 05	26	25	34	161	78	56			
U163	●	D3 26,5 WCMX 05	26,5	25	34	161	78	56			
U164	●	D3 27 WCMX 05	27	25	34	164	81	56			
U165	●	D3 27,5 WCMX 05	27,5	25	34	164	81	56			
U166	●	D3 28 WCMX 05	28	25	34	168	84	56			
U167	●	D3 28,5 WCMX 05	28,5	25	34	168	84	56			
U168	●	D3 29 WCMX 05	29	25	34	171	87	56			
U169	●	D3 29,5 WCMX 05	29,5	25	34	171	87	56			

● Stokta / In Stock / Lager ○ Sınırlı Stok / Limited Stock / Begrenzte Lagerhaltung  
KRLY ucuna uygundur. / Compatible with KRLY insert. / Kompatibel für KRLY WP

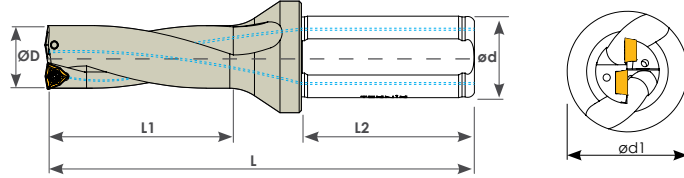

U9  
D3 WCMX

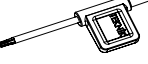

Sipariş Kodu Order Code Best.-Nr.	Stok/Stock/Lager	Ürün Kodu Product Code Produkt-Code	Ölçüler (mm) Dimensions (mm) Abmessungen (mm)						Kullanılan Uç Insert WSP	Sıkma Cıvatası Clamp Screw Torx-Schraube	Anahtar Torx Key Torx-Schlüssel
			ØD	ød	d1	L	L1	L2			
U170	●	D3 30 WCMX 06	30	32	44	181	90	58	WCMX 06T3 KRLY	TC067 M3,5x9	T15
U171	●	D3 30,5 WCMX 06	30,5	32	44	181	90	58			
U172	●	D3 31 WCMX 06	31	32	44	185	93	58			
U174	●	D3 32 WCMX 06	32	32	44	188	96	58			
U176	●	D3 33 WCMX 06	33	32	44	192	99	58			
U178	●	D3 34 WCMX 06	34	32	44	195	102	58			
U179	●	D3 35 WCMX 06	35	32	44	199	105	58			
U180	●	D3 36 WCMX 06	36	32	44	203	108	58			
U181	●	D3 37 WCMX 06	37	32	44	207	111	58			
U182	●	D3 38 WCMX 06	38	32	44	211	114	58			
U183	●	D3 39 WCMX 06	39	32	44	214	117	58			
U184	●	D3 40 WCMX 06	40	32	44	218	120	58			
U186	●	D3 41 WCMX 06	41	32	49	232	123	58			
U188	●	D3 42 WCMX 06	42	32	49	235	126	58			
U190	●	D3 43 WCMX 06	43	32	49	239	129	58			
U192	●	D3 44 WCMX 06	44	32	49	242	132	58			
U194	●	D3 45 WCMX 06	46	40	59	247	135	68			
U196	●	D3 46 WCMX 06	46	40	59	251	138	68			
U198	●	D3 47 WCMX 06	47	40	59	254	141	68			
U200	●	D3 48 WCMX 08	48	40	59	258	144	68			
U201	●	D3 49 WCMX 08	49	40	59	261	147	68			
U202	●	D3 50 WCMX 08	50	40	59	265	150	68			
U203	●	D3 51 WCMX 08	51	40	59	268	153	68			
U205	●	D3 52 WCMX 08	52	40	59	271	156	68			
U207	●	D3 53 WCMX 08	53	40	59	274	159	68			
U209	●	D3 54 WCMX 08	54	40	59	277	162	68			
U211	●	D3 55 WCMX 08	55	40	59	280	165	68			

● Stokta/ In Stock / Lager ○ Sınırlı Stok / Limited Stock / Begrenzte Lagerhaltung  
KRLY ucuna uygundur. / Compatible with KRLY insert. / Kompatible für KRLY WP

**U9**  
**D4 WCMX**

**تکنیک تولز**

ابزار آلات صنعتی، تراشکاری و قابلسازی  
۶۶۷۱۱۹۶۷ - ۶۶۷۱۱۷۲۹  
تهران، خ امام خمینی، م حسن آباد، پاساژ هشت گنبد، شماره ۱۵

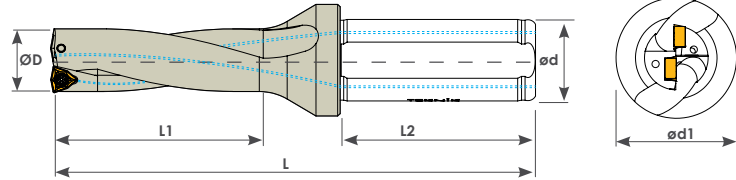

Sipariş Kodu Order Code Best.-Nr.	Stok/Stock/Lager	Ürün Kodu Product Code Produkt-Code	Ölçüler (mm) Dimensions (mm) Abmessungen (mm)						Kullanılan Uç Insert WSP	Sıkma Cıvatası Clamp Screw Torx-Schraube	Anahtar Torx Key Torx-Schlüssel
			ØD	ød	d1	L	L1	L2			
U600	●	D4 16 WCMX 03	16	25	34	140	64	56	WCMX 0302 KRLY	TC060 M2,5x5,5	T8
U602	●	D4 17 WCMX 03	17	25	34	144	68	56			
U604	●	D4 18 WCMX 03	18	25	34	149	72	56			
U606	●	D4 19 WCMX 03	19	25	34	153	76	56			
U608	●	D4 20 WCMX 04	20	25	34	159	80	56			
U610	●	D4 21 WCMX 04	21	25	34	163	84	56			
U612	●	D4 22 WCMX 04	22	25	34	167	88	56			
U614	●	D4 23 WCMX 04	23	25	34	173	92	56			
U616	●	D4 24 WCMX 05	24	25	34	178	96	56			
U618	●	D4 25 WCMX 05	25	25	34	183	100	56			
U620	●	D4 26 WCMX 05	26	25	34	187	104	56	WCMX 0503 KRLY	TC065 M3x7	
U622	●	D4 27 WCMX 05	27	25	34	191	108	56			
U624	●	D4 28 WCMX 05	28	25	34	196	112	56	WCMX 06T3 KRLY	TC067 M3,5x9	T15
U626	●	D4 29 WCMX 05	29	25	34	200	116	56			
U628	●	D4 30 WCMX 06	30	32	44	211	120	58			
U631	●	D4 31 WCMX 06	31	32	44	216	124	58			
U632	●	D4 32 WCMX 06	32	32	44	220	128	58			
U633	●	D4 33 WCMX 06	33	32	44	225	132	58			
U634	●	D4 34 WCMX 06	34	32	44	229	136	58			
U635	●	D4 35 WCMX 06	35	32	44	234	140	58			
U636	●	D4 36 WCMX 06	36	32	44	239	144	58			
U637	●	D4 37 WCMX 06	37	32	44	244	148	58			
U638	●	D4 38 WCMX 06	38	32	44	249	152	58			
U639	●	D4 39 WCMX 06	39	32	44	253	156	58			
U640	●	D4 40 WCMX 06	40	32	44	258	160	58			

● Stokta/ In Stock / Lager ○ Sınırlı Stok / Limited Stock / Begrenzte Lagerhaltung  
KRLY ucuna uygundur. / Compatible with KRLY insert. / Kompatible für KRLY WP

U9  
D5 WCMX

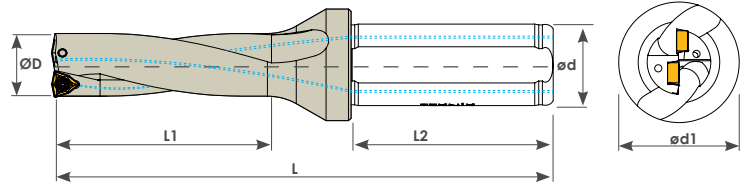

Sipariş Kodu Order Code Best.-Nr.	Stok/Stock/Lager	Ürün Kodu Product Code Produkt-Code	Ölçüler (mm) Dimensions (mm) Abmessungen (mm)						Kullanılan Uç Insert WSP	Sıkma Civatası Clamp Screw Torx-Schraube	Anahtar Torx Key Torx-Schlüssel
			ØD	ød	d1	L	L1	L2			
U776	○	D5 16 WCMX 03	16	25	34	156	80	56	WCMX 0302 KRLY	TC060 M2,5x5,5	T8
U777	○	D5 17 WCMX 03	17	25	34	161	85	56			
U778	○	D5 18 WCMX 03	18	25	34	167	90	56			
U779	○	D5 19 WCMX 03	19	25	34	172	95	56			
U780	○	D5 20 WCMX 04	20	25	34	179	100	56	WCMX 0402 KRLY		
U781	○	D5 21 WCMX 04	21	25	34	184	105	56			
U782	○	D5 22 WCMX 04	22	25	34	190	110	56			
U783	○	D5 23 WCMX 04	23	25	34	196	115	56			
U784	○	D5 24 WCMX 05	24	25	34	202	120	56			
U785	○	D5 25 WCMX 05	25	25	34	208	125	56	WCMX 0503 KRLY	TC065 M3x7	
U786	○	D5 26 WCMX 05	26	25	34	213	130	56			
U787	○	D5 27 WCMX 05	27	25	34	218	135	56			
U788	○	D5 28 WCMX 05	28	25	34	224	140	56			
U789	○	D5 29 WCMX 05	29	25	34	229	145	56			
U790	○	D5 30 WCMX 06	30	32	44	241	150	58	WCMX 06T3 KRLY	TC067 M3,5x9	T15
U791	○	D5 31 WCMX 06	31	32	44	246	155	58			
U792	○	D5 32 WCMX 06	32	32	44	252	160	58			
U793	○	D5 33 WCMX 06	33	32	44	258	165	58			
U794	○	D5 34 WCMX 06	34	32	44	263	170	58			
U795	○	D5 35 WCMX 06	35	32	44	269	175	58			
U796	○	D5 36 WCMX 06	36	32	44	275	180	58			
U797	○	D5 37 WCMX 06	37	32	44	281	185	58			
U798	○	D5 38 WCMX 06	38	32	44	287	190	58			
U799	○	D5 39 WCMX 06	39	32	44	292	195	58			
U800	○	D5 40 WCMX 06	40	32	44	298	200	58			

● Stokta / In Stock / Lager ○ Sınırlı Stok / Limited Stock / Begrenzte Lagerhaltung  
KRLY ucuna uygundur. / Compatible with KRLY insert. / Kompatible für KRLY WP

U10  
D2 SPMG

تکنیک تولز

ابزار آلات صنعتی، تراشکاری و قالبسازی  
۶۶۷۱۱۶۶۹ - ۶۶۷۱۱۷۶۹  
تهران، خ امام خمینی، م حسن آباد، پاساژ هشت گنبد، شماره ۱۵

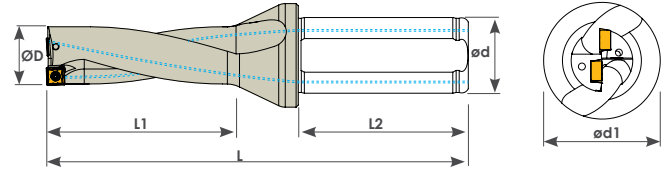



Sipariş Kodu Order Code Best.-Nr.	Stok/Stock/Lager	Ürün Kodu Product Code Produkt-Code	Ölçüler (mm) Dimensions (mm) Abmessungen (mm)						Kullanılan Uç Insert WSP	Sıkma Civatası Clamp Screw Torx-Schraube	Anahtar Torx Key Torx-Schlüssel
			ØD	ød	d1	L	L1	L2			
U913	●	D2 13 SPMG 05	13	20	25	94	26	50	SPMG 0502 TGTC	TC058 M2x4,2	T6
U914	●	D2 14 SPMG 05	14	20	25	96	28	50			
U915	●	D2 15 SPMG 05	15	20	25	99	30	50			
U916	●	D2 16 SPMG 06	16	25	34	108	32	56	SPMG 0602 TGTC	TC059 M2,2x5	T7
U917	●	D2 17 SPMG 06	17	25	34	110	34	56			
U918	●	D2 18 SPMG 06	18	25	34	113	36	56			
U919	●	D2 19 SPMG 06	19	25	34	115	38	56			
U920	●	D2 20 SPMG 06	20	25	34	119	40	56			
U921	●	D2 21 SPMG 06	21	25	34	121	42	56			
U922	●	D2 22 SPMG 07	22	25	34	123	44	56	SPMG 07T3 TGTC	TC063 M2,5x7	T8
U923	●	D2 23 SPMG 07	23	25	34	127	46	56			
U924	●	D2 24 SPMG 07	24	25	34	130	48	56			
U925	●	D2 25 SPMG 07	25	25	34	133	50	56			
U926	●	D2 26 SPMG 07	26	25	34	135	52	56			
U927	●	D2 27 SPMG 07	27	25	34	137	54	56			
U928	●	D2 28 SPMG 09	28	25	34	140	56	56	SPMG 0904 TGTC	TC067 M3,5x9	T15
U929	●	D2 29 SPMG 09	29	25	34	142	58	56			
U930	●	D2 30 SPMG 09	30	32	44	151	60	58			
U931	●	D2 31 SPMG 09	31	32	44	154	62	58			
U932	●	D2 32 SPMG 09	32	32	44	156	64	58			
U933	●	D2 33 SPMG 09	33	32	44	159	66	58			
U934	●	D2 34 SPMG 11	34	32	44	161	68	58	SPMG 1104 TGTC	TC074 M4x10	T15
U935	●	D2 35 SPMG 11	35	32	44	164	70	58			
U936	●	D2 36 SPMG 11	36	32	44	167	72	58			
U937	●	D2 37 SPMG 11	37	32	44	170	74	58			
U938	●	D2 38 SPMG 11	38	32	44	173	76	58			
U939	●	D2 39 SPMG 11	39	32	44	175	78	58			
U940	●	D2 40 SPMG 11	40	32	44	178	80	58			

● Stokta/ In Stock / Lager ○ Sınırlı Stok / Limited Stock / Begrenzte Lagerhaltung  
TGTCucuna uygundur. / Compatible with TGTCinsert. / Kompatibel für TGTCWP

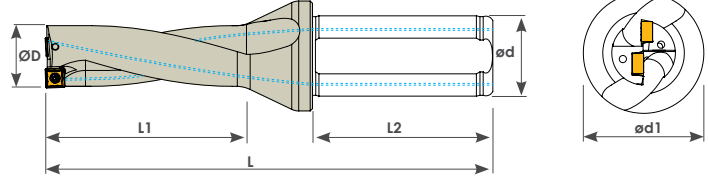
U10  
D3 SPMG

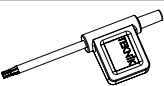

Sipariş Kodu Order Code Code Best.-Nr.	Stok/Stock/Lager	Ürün Kodu Product Code Produkt-Code	Ölçüler (mm) Dimensions (mm) Abmessungen (mm)						Kullanılan Uç Insert WSP	Sıkma Civatası Clamp Screw Torx-Schraube	Anahtar Torx Key Torx-Schlüssel
			ØD	ød	d1	L	L1	L2			
U813	●	D3 13 SPMG 05	13	20	25	107	39	50	SPMG 0502 TGTC	TC058 M2x4,2	T6
U813-1	●	D3 13,5 SPMG 05	13,5	20	25	107	39	50			
U814	●	D3 14 SPMG 05	14	20	25	110	42	50			
U814-1	●	D3 14,5 SPMG 05	14,5	20	25	110	42	50			
U815	●	D3 15 SPMG 05	15	20	25	114	45	50			
U815-1	●	D3 15,5 SPMG 05	15,5	20	25	114	45	50	SPMG 0602 TGTC	TC059 M2,2x5	T7
U816	●	D3 16 SPMG 06	16	25	34	124	48	56			
U816-1	●	D3 16,5 SPMG 06	16,5	25	34	124	48	56			
U817	●	D3 17 SPMG 06	17	25	34	127	51	56			
U817-1	●	D3 17,5 SPMG 06	17,5	25	34	127	51	56			
U818	●	D3 18 SPMG 06	18	25	34	131	54	56			
U818-1	●	D3 18,5 SPMG 06	18,5	25	34	131	54	56			
U819	●	D3 19 SPMG 06	19	25	34	134	57	56			
U819-1	●	D3 19,5 SPMG 06	19,5	25	34	134	57	56			
U820	●	D3 20 SPMG 06	20	25	34	139	60	56			
U820-1	●	D3 20,5 SPMG 06	20,5	25	34	139	60	56			
U821	●	D3 21 SPMG 06	21	25	34	142	63	56			
U821-1	●	D3 21,5 SPMG 06	21,5	25	34	142	63	56			
U822	●	D3 22 SPMG 07	22	25	34	145	66	56			
U822-1	●	D3 22,5 SPMG 07	22,5	25	34	145	66	56			
U823	●	D3 23 SPMG 07	23	25	34	150	69	56			
U823-1	●	D3 23,5 SPMG 07	23,5	25	34	150	69	56			
U824	●	D3 24 SPMG 07	24	25	34	154	72	56			
U824-1	●	D3 24,5 SPMG 07	24,5	25	34	154	72	56			
U825	●	D3 25 SPMG 07	25	25	34	157	75	56	SPMG 07T3 TGTC	TC063 M2,5x7	T8
U825-1	●	D3 25,5 SPMG 07	25,5	25	34	157	75	56			
U826	●	D3 26 SPMG 07	26	25	34	161	78	56			
U826-1	●	D3 26,5 SPMG 07	26,5	25	34	161	78	56			
U827	●	D3 27 SPMG 07	27	25	34	164	81	56	SPMG 07T3 TGTC	TC063 M2,5x7	T8
U827-1	●	D3 27,5 SPMG 07	27,5	25	34	164	81	56			

● Stokta/ In Stock / Lager ○ Sınırlı Stok / Limited Stock / Begrenzte Lagerhaltung  
TGTCucuna uygundur. / Compatible with TGTCinsert. / Kompatible für TGTCWP

**U10**  
**D3 SPMG**

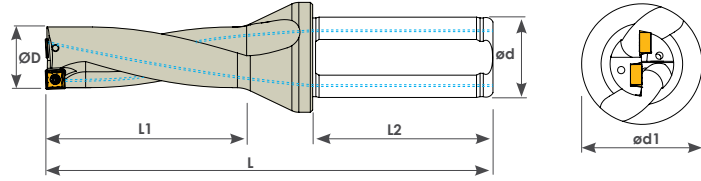

Sipariş Kodu Order Code Best.-Nr.	Stok/Stock/Lager	Ürün Kodu Product Code Produkt-Code	Ölçüler (mm) Dimensions (mm) Abmessungen (mm)						Kullanılan Uç Insert WSP	Sıkma Civatası Clamp Screw Torx-Schraube	Anahtar Torx Key Torx-Schlüssel			
			ØD	ød	d1	L	L1	L2						
U828	●	D3 28 SPMG 09	28	25	34	168	84	56	SPMG 0904 TGTC	TC067 M3,5x9	T15			
U828-1	●	D3 28,5 SPMG 09	28,5	25	34	168	84	56						
U829	●	D3 29 SPMG 09	29	25	34	171	87	56						
U829-1	●	D3 29,5 SPMG 09	29,5	25	34	171	87	56						
U830	●	D3 30 SPMG 09	30	32	44	181	90	58						
U831	●	D3 31 SPMG 09	31	32	44	185	93	58						
U832	●	D3 32 SPMG 09	32	32	44	188	96	58						
U833	●	D3 33 SPMG 09	33	32	44	192	99	58						
U834	●	D3 34 SPMG 11	34	32	44	195	102	58				SPMG 1104 TGTC	TC074 M4x10	T15
U835	●	D3 35 SPMG 11	35	32	44	199	105	58						
U836	●	D3 36 SPMG 11	36	32	44	203	108	58						
U837	●	D3 37 SPMG 11	37	32	44	207	111	58						
U838	●	D3 38 SPMG 11	38	32	44	211	114	58						
U839	●	D3 39 SPMG 11	39	32	44	214	117	58						
U840	●	D3 40 SPMG 11	40	32	44	218	120	58						

● Stokta / In Stock / Lager ○ Sınırlı Stok / Limited Stock / Begrenzte Lagerhaltung  
TGTCucuna uygundur. / Compatible with TGTCinsert. / Kompatible für TGTCWP

**U10  
D4 SPMG**

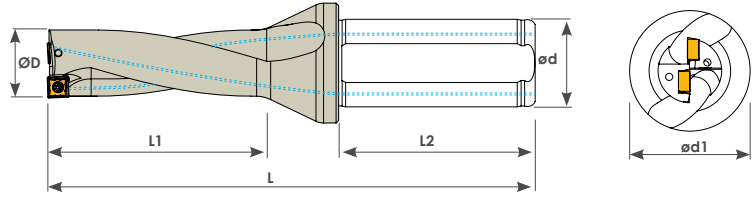

Sipariş Kodu Order Code Best.-Nr.	Stok/Stock/Lager	Ürün Kodu Product Code Produkt-Code	Ölçüler (mm) Dimensions (mm) Abmessungen (mm)						Kullanılan Uç Insert WSP	Sıkma Civatası Clamp Screw Torx-Schraube	Anahtar Torx Key Torx-Schlüssel
			ØD	ød	d1	L	L1	L2			
U713	●	D4 13 SPMG 05	13	20	25	120	52	50	SPMG 0502 TGTC	TC058 M2x4,2	T6
U714	●	D4 14 SPMG 05	14	20	25	124	56	50			
U715	●	D4 15 SPMG 05	15	20	25	129	60	50			
U716	●	D4 16 SPMG 06	16	25	34	140	64	56			
U717	●	D4 17 SPMG 06	17	25	34	144	68	56	SPMG 0602 TGTC	TC059 M2,2x5	T7
U718	●	D4 18 SPMG 06	18	25	34	149	72	56			
U719	●	D4 19 SPMG 06	19	25	34	153	76	56			
U720	●	D4 20 SPMG 06	20	25	34	159	80	56			
U721	●	D4 21 SPMG 06	21	25	34	163	84	56	SPMG 07T3 TGTC	TC063 M2,5x7	T8
U722	●	D4 22 SPMG 07	22	25	34	167	88	56			
U723	●	D4 23 SPMG 07	23	25	34	173	92	56			
U724	●	D4 24 SPMG 07	24	25	34	178	96	56			
U725	●	D4 25 SPMG 07	25	25	34	183	100	56	SPMG 0904 TGTC	TC067 M3,5x9	T15
U726	●	D4 26 SPMG 07	26	25	34	187	104	56			
U727	●	D4 27 SPMG 07	27	25	34	191	108	56			
U728	●	D4 28 SPMG 09	28	25	34	196	112	56			
U729	●	D4 29 SPMG 09	29	25	34	200	116	56	SPMG 1104 TGTC	TC074 M4x10	T15
U730	●	D4 30 SPMG 09	30	32	44	211	120	58			
U731	●	D4 31 SPMG 09	31	32	44	216	124	58			
U732	●	D4 32 SPMG 09	32	32	44	220	128	58			
U733	●	D4 33 SPMG 09	33	32	44	225	132	58	SPMG 1104 TGTC	TC074 M4x10	T15
U734	●	D4 34 SPMG 11	34	32	44	229	136	58			
U735	●	D4 35 SPMG 11	35	32	44	234	140	58			
U736	●	D4 36 SPMG 11	36	32	44	239	144	58			
U737	●	D4 37 SPMG 11	37	32	44	244	148	58	SPMG 1104 TGTC	TC074 M4x10	T15
U738	●	D4 38 SPMG 11	38	32	44	249	152	58			
U739	●	D4 39 SPMG 11	39	32	44	253	156	58			
U740	●	D4 40 SPMG 11	40	32	44	258	160	58			

● Stokta / In Stock / Lager ○ Sınırlı Stok / Limited Stock / Begrenzte Lagerhaltung  
TGTCucuna uygundur. / Compatible with TGTCinsert. / Kompatible für TGTCWP

**U12  
D3 SPMT**

**تکنیک تولز**

ابزار آلات صنعتی، تراشکاری و قابلسازی  
۶۶۷۱۱۷۲۹ - ۶۶۷۱۱۹۶۷  
تهران، خ امام خمینی، م حسن ایاد، پاساژ هشت گنبد، شماره ۱۵

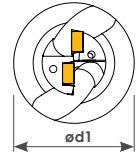
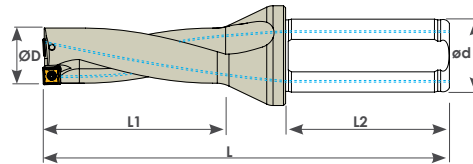

Sipariş Kodu Order Code Best.-Nr.	Stok/Stock/Lager	Ürün Kodu Product Code Produkt-Code	Ölçüler (mm) Dimensions (mm) Abmessungen (mm)						Kullanılan Uç Insert WSP	Sıkma Cıvatası Clamp Screw Torx-Schraube	Anahtar Torx Key Torx-Schlüssel
			ØD	ød	d1	L	L1	L2			
U004	●	D3 13 SPMT 05	13	20	25	107	39	50	SPMT 0502 KRLY	TC058 M2x4,2	T6
U006	●	D3 14 SPMT 05	14	20	25	110	42	50			
U008	●	D3 15 SPMT 05	15	20	25	114	45	50			
U010	●	D3 16 SPMT 06	16	25	34	124	48	56	SPMT 0602 KRLY	TC059 M2,2x5	T7
U012	●	D3 17 SPMT 06	17	25	34	127	51	56			
U014	●	D3 18 SPMT 06	18	25	34	131	54	56			
U016	●	D3 19 SPMT 06	19	25	34	134	57	56			
U018	●	D3 20 SPMT 07	20	25	34	139	60	56	SPMT 0702 KRLY	TC063 M2,5x7	T8
U020	●	D3 21 SPMT 07	21	25	34	142	63	56			
U022	●	D3 22 SPMT 07	22	25	34	145	66	56			

● Stokta / In Stock / Lager ○ Sınırlı Stok / Limited Stock / Begrenzte Lagerhaltung  
KRLY ucuna uygundur. / Compatible with KRLY insert. / Kompatible für KRLY WP





**U14**  
**D2-D3 XCMT-QCMT**

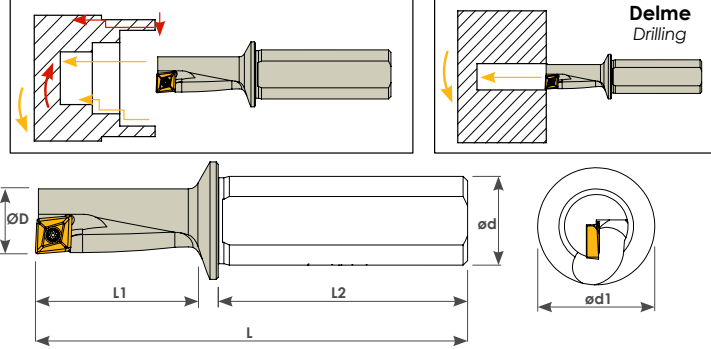

Sipariş Kodu Order Code Best.-Nr.	Stok/Stock/Lager	Ürün Kodu Product Code Produkt-Code	Ölçüler (mm) Dimensions(mm) Abmessungen (mm)						Kullanılan Uç Insert WSP	Sıkma Cıvatası Clamp Screw Torx-Schraube	Anahtar Torx Key Torx-Schlüssel
			D	d	d1	L	L1	L2			
U030	●	D2,25 10 QC-- 050204	10	12	16	74,5	22,5	42	QC-- 050204	TC058 M2x4,2	T6
U032	●	D2,25 12 QC-- 060204	12	16	20	85	27	45	QC-- 060204	TC059 M2,2x5	T7
U034	●	D2,25 14 QC-- 070304	14	16	20	90	31,5	45	QC-- 070304	TC060 M2,5x5,5	T8
U036	●	D2,25 16 QC-- 080304	16	20	25	100	36	50	QC-- 080304	TC065 M3x7	
U038	●	D2,25 18 QC-- 09T304	18	25	31	112	40,5	56	QC-- 09T304	TC067 M3,5x9	
U040	●	D2,25 20 QC-- 10T304	20	25	31	116	45	56	QC-- 10T304	TC080 M4,5x11	T15
U042	●	D2,25 25 QC-- 130404	25	32	39	135	56,5	60	QC-- 130404		

KRLY ucuna uygundur. / Compatible with KRLY insert. / Kompatible für KRLY WP

Sipariş Kodu Order Code Best.-Nr.	Stok/Stock/Lager	Ürün Kodu Product Code Produkt-Code	Ölçüler (mm) Dimensions(mm) Abmessungen (mm)						Kullanılan Uç Insert WSP	Sıkma Cıvatası Clamp Screw Torx-Schraube	Anahtar Torx Key Torx-Schlüssel
			D	d	d1	L	L1	L2			
U08	●	D2 8 XC-- 040104	8	12	16	68	18	42	XCMT 040104	TC051 M1,8	T6
U12	●	D3 10 XC-- 050204	10	16	25	90	30	45	XCMT 050204	TC058 M2x4,5	
U14	●	D3 10,5 XC-- 050204	10,5	16	25	90	31	45	XCMT 060204	TC059 M2,2x5	
U18	●	D3 11,5 XC-- 060204	11,5	16	25	92	35	45			
U20	●	D3 12 XC-- 060204	12	16	25	94	36	45			

TGTCucuna uygundur. / Compatible with TGTCinsert. / Kompatible für TGTCWP

**Alüminyum için/For Aluminum/ Für Aluminium**

Sipariş Kodu Order Code Best.-Nr.	Stok/Stock/Lager	Ürün Kodu Product Code Produkt-Code	Ölçüler (mm) Dimensions(mm) Abmessungen (mm)						Kullanılan Uç Insert WSP	Sıkma Cıvatası Clamp Screw Torx-Schraube	Anahtar Torx Key Torx-Schlüssel
			D	d	d1	L	L1	L2			
U32	●	D3 10,5 XC-- 050204	10,5	16	25	90	31	45	XCGT 050204	TC058 M2x4,2	T6
U34	●	D3 11 XC-- 050204	11	16	25	92	33	45	XCGT 060204	TC059 M2,2x5	T7
U36	●	D3 11,5 XC-- 060204	11,5	16	25	92	35	45			

● Stokta/ In Stock / Lager ○ Sınırlı Stok / Limited Stock / Begrenzte Lagerhaltung  
TGTCucuna uygundur. / Compatible with TGTCinsert. / Kompatible für TGTCWP



تکنیک تولز

ابزار آلات صنعتی، تراشکاری و فالپساری

۶۶۷۱۱۶۶ - ۶۶۷۱۱۶۶

تهران، خ امام خمینی، م حسن آباد، پاساژ هشت گنبد، شماره ۱۵

**Kanal Kater**  
Grooving Holders  
Stech-Klemmhalter

**D10**  
**KRLY**  
Type A KRLY

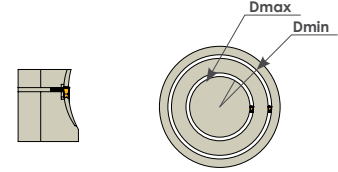
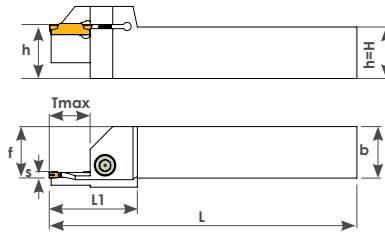

Sipariş Kodu Order Code Best.-Nr.	Stok/Stock/Lager	Ürün Kodu Product Code Produkt-Code	Ölçüler (mm) Dimensions (mm) Abmessungen (mm)									Kullanılan Uç Insert WSP	Sıkma Cıvatası Clamp Screw Inbuss-Schraube	Anahtar Allen Key Inbuss-Schlüssel
			Dmin	Dmax	S	Tmax	f	b	h=H	L	L1			
D780	●	2525 3C-R (50-60)	50	60	3	17	25	25	25	150	40	MGM 3 KRLY	TC134 M6x20	5 Allen
D782	●	2525 3C-R (60-80)	60	80	3	17	25	25	25	150	40			
D784	●	2525 3C-R (80-110)	80	110	3	17	25	25	25	150	40			
D785	●	2525 3C-R (110-150)	110	150	3	17	25	25	25	150	40			
D786	●	2525 4C-R (50-60)	50	60	4	20	25	25	25	150	45	MGM 4 KRLY		
D788	●	2525 4C-R (60-80)	60	80	4	20	25	25	25	150	45			
D790	●	2525 4C-R (80-110)	80	110	4	20	25	25	25	150	45			
D791	●	2525 4C-R (110-150)	110	150	4	20	25	25	25	150	45			
D791-1	●	2525 4C (140-600)	140	600	4	25	25	25	25	150	49	MGM 5 KRLY		
D792	●	2525 5C-R (50-80)	50	80	5	20	25	25	25	150	45			
D796	●	2525 5C-R (80-110)	80	110	5	20	25	25	25	150	45			
D798	●	2525 5C-R (110-150)	110	150	5	20	25	25	25	150	45			
D799	●	2525 5C-R (140-350)	140	350	5	20	25	25	25	150	45	MGM 5 KRLY		
D799-1	●	2525 5C-R (350-500)	350	500	5	20	25	25	25	150	45			
D799-2	●	2525 5C-R (140-600)	140	600	5	25	25	25	25	150	49			

● Stokta / In Stock / Lager ○ Sınırlı Stok / Limited Stock / Begrenzte Lagerhaltung  
KRLY ucuna uygundur. / Compatible with KRLY insert. / Kompatible für KRLY WP



**D10**  
**A TİPİ KRLY**  
Type A KRLY

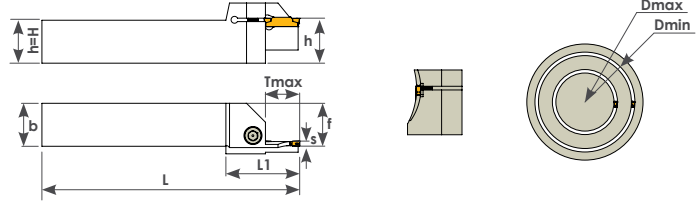

Sipariş Kodu Order Code Best.-Nr.	Stok/Stock/Lager	Ürün Kodu Product Code Produkt-Code	Ölçüler (mm) Dimensions(mm) Abmessungen (mm)									Kullanılan Uç Insert WSP	Sıkma Civatası Clamp Screw Inbuss-Schraube	Anahtar Allen Key Inbuss-Schlüssel
			Dmin	Dmax	S	Tmax	f	b	h=H	L	L1			
D800	●	2525 3C-L (50-60)	50	60	3	17	25	25	25	150	40	MGM 3 KRLY	TC134 M6x20	5 Allen
D802	●	2525 3C-L (60-80)	60	80	3	17	25	25	25	150	40			
D804	●	2525 3C-L (80-110)	80	110	3	17	25	25	25	150	40			
D805	●	2525 3C-L (110-150)	110	150	3	17	25	25	25	150	40			
D806	●	2525 4C-L (50-60)	50	60	4	20	25	25	25	150	45	MGM 4 KRLY	TC134 M6x20	5 Allen
D808	●	2525 4C-L (60-80)	60	80	4	20	25	25	25	150	45			
D810	●	2525 4C-L (80-110)	80	110	4	20	25	25	25	150	45			
D811	●	2525 4C-L (110-150)	110	150	4	20	25	25	25	150	45			
D811-1	●	2525 4C-L (140-600)	140	600	4	25	25	25	25	150	49	MGM 5 KRLY	TC134 M6x20	5 Allen
D812	●	2525 5C-L (50-80)	50	80	5	20	25	25	25	150	45			
D816	●	2525 5C-L (80-110)	80	110	5	20	25	25	25	150	45			
D818	●	2525 5C-L (110-150)	110	150	5	20	25	25	25	150	45			
D819	●	2525 5C-L (140-600)	140	600	5	25	25	25	25	150	49	MGM 5 KRLY	TC134 M6x20	5 Allen
D819-1	●	2525 5C-L (350-500)	350	500	5	20	25	25	25	150	45			

● Stokta/ In Stock / Lager ○ Sınırlı Stok / Limited Stock / Begrenzte Lagerhaltung  
KRLY ucuna uygundur. / Compatible with KRLY insert. / Kompatibel für KRLY WP

**تکنیک تولز**  
ایران آلات صنعتی، تراشکاری و قالبسازی  
۶۶۷۱۱۶۶ - ۶۶۷۱۱۷۲۹  
تهران، خ امام خمینی، م حسن آباد، پاساژ هشت گنبد، شماره ۱۵

D10  
MGM /R

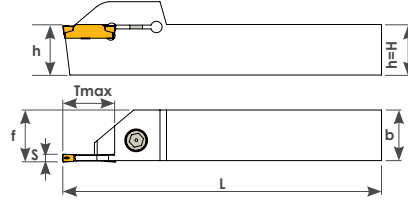

Sipariş Kodu Order Code Best.-Nr.	Stok/Stock/Lager	Ürün Kodu Product Code Produkt-Code	Ölçüler (mm) Dimensions(mm) Abmessungen (mm)						Kullanılan Uç Insert WSP	Sıkma Cıvatası Clamp Screw Inbuss-Schraube	Anahtar Allen Key Inbuss-Schlüssel
			h=H	b	S	Tmax	f	L			
D658	●	1212 2C-R MGM	12	12	2	16	12	125	2C MGM KRLY	TC132 M5x20	4 Allen
D660	●	1616 2C-R MGM	16	16	2	16	16	125			
D662	●	2020 2C-R MGM	20	20	2	16	20	125			
D664	●	2525 2C-R MGM	25	25	2	16	25	150			
D666	●	3232 2C-R MGM	32	32	2	16	32	170			
D667	●	1212 3C-R MGM	12	12	3	18	12	125	3C MGM KRLY	TC132 M5x20	4 Allen
D668	●	1616 3C-R MGM	16	16	3	18	16	125			
D670	●	2020 3C-R MGM	20	20	3	18	20	125			
D672	●	2525 3C-R MGM	25	25	3	18	25	150			
D674	●	3232 3C-R MGM	32	32	3	18	32	170	4C MGM KRLY	TC132 M5x20	4 Allen
D675	●	1616 4C-R MGM	16	16	4	18	16	125			
D676	●	2020 4C-R MGM	20	20	4	18	20	125			
D678	●	2525 4C-R MGM	25	25	4	18	25	150	TC134 M6x20	5 Allen	
D680	●	3232 4C-R MGM	32	32	4	18	32	170			
D682	●	2020 5C-R MGM	20	20	5	24	20	125	5C MGM KRLY	TC132 M5x20	4 Allen
D684	●	2525 5C-R MGM	25	25	5	25	25	150		TC134 M6x20	5 Allen
D686	●	3232 5C-R MGM	32	32	5	24	32	170		TC136 M8x20	6 Allen
D687	●	2525 6C-R MGM	25	25	6	24	25	150	TC134 M6x20	5 Allen	

KRLY ucuna uygundur. / Compatible with KRLY insert. / Kompatible für KRLY WP

D10  
MGM /R

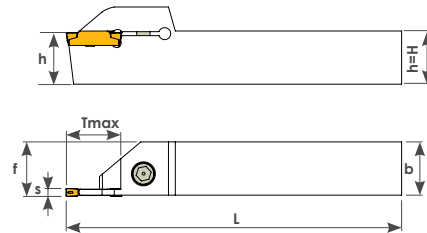

Sipariş Kodu Order Code Best.-Nr.	Stok/Stock/Lager	Ürün Kodu Product Code Produkt-Code	Ölçüler (mm) Dimensions(mm) Abmessungen (mm)						Kullanılan Uç Insert WSP	Sıkma Cıvatası Clamp Screw Inbuss-Schraube	Anahtar Allen Key Inbuss-Schlüssel
			h	b	S	Tmax	f	L			
D960	●	2525 3C-R MGM	25	25	3	25	25	150	3C MGM KRLY	TC134 M6x20	5 Allen
D963	●	2525 3C-R MGM	25	25	3	40	25	170			
D961	●	2525 4C-R MGM	25	25	4	25	25	150	4C MGM KRLY		
D964	●	2525 4C-R MGM	25	25	4	40	25	170			
D962	●	2525 5C-R MGM	25	25	5	40	25	170	5C MGM KRLY		

● Stokta / In Stock / Lager ○ Sınırlı Stok / Limited Stock / Begrenzte Lagerhaltung  
KRLY ucuna uygundur. / Compatible with KRLY insert. / Kompatible für KRLY WP

## D10 MGM /L

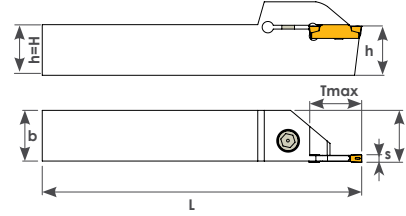

Sipariş Kodu Order Code Best.-Nr.	Stok/Stock/Lager	Ürün Kodu Product Code Produkt-Code	Ölçüler (mm) Dimensions (mm) Abmessungen (mm)						Kullanılan Uç Insert WSP	Sıkma Cıvatası Clamp Screw Inbuss-Schraube	Anahtar Allen Key Inbuss-Schlüssel
			h=H	b	S	Tmax	f	L			
D610	●	2020 2C-L MGM	20	20	2	16	20	125	2C MGM KRLY	TC132 M5x20	4 Allen
D612	●	1616 3C-L MGM	16	16	3	18	16	125	3C MGM KRLY		
D614	●	2020 3C-L MGM	20	20	3	19	20	125		4C MGM KRLY	TC134 M6x20
D615	●	2525 3C-L MGM	25	25	3	18	25	150	5C MGM KRLY		TC132 M5x20
D617	●	2020 4C-L MGM	20	20	4	18	20	125		TC134 M6x20	5 Allen
D618	●	2525 4C-L MGM	25	25	4	18	25	150	TC132 M5x20		4 Allen
D620	●	2525 5C-L MGM	25	25	5	24	25	150		TC134 M6x20	5 Allen

KRLY ucuna uygundur. / Compatible with KRLY insert. / Kompatible für KRLY WP

## D12 GRP /R

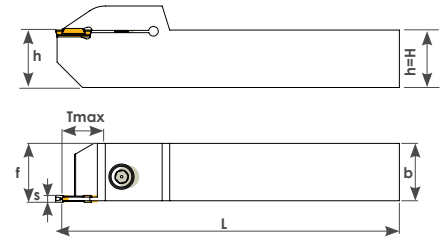



Sipariş Kodu Order Code Best.-Nr.	Stok/Stock/Lager	Ürün Kodu Product Code Produkt-Code	Ölçüler (mm) Dimensions (mm) Abmessungen (mm)						Kullanılan Uç Insert WSP	Sıkma Cıvatası Clamp Screw Inbuss-Schraube	Anahtar Allen Key Inbuss-Schlüssel
			h=H	b	S	Tmax	f	L			
D773	●	2020 3C-R GRP	20	20	3	18	20	125	3C GRP ISCR	TC132 M5x20	4 Allen
D769	●	2525 3C-R GRP	25	25	3	18	25	150			
D770	●	2525 4C-R GRP	25	25	4	18	25	150	4C GRP ISCR	TC134 M6x20	5 Allen
D772	●	3232 4C-R GRP	32	32	4	18	32	170			
D771	●	2525 5C-R GRP	25	25	5	24	25	150	5C GRP ISCR	TC134 M6x20	5 Allen
D774	●	3232 5C-R GRP	32	32	5	24	32	170			

● Stokta / In Stock / Lager ○ Sınırlı Stok / Limited Stock / Begrenzte Lagerhaltung  
ISCR ucuna uygundur. / Compatible with ISCR insert. / Kompatible für ISCR WP

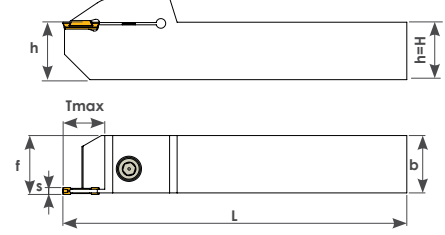
**D14**  
**KGMN /R**



Sipariş Kodu Order Code Best.-Nr.	Stok/Stock/Lager	Ürün Kodu Product Code Produkt-Code	Ölçüler (mm) Dimensions (mm) Abmessungen (mm)						Kullanılan Uç Insert WSP	Sıkma Civatası Clamp Screw Inbuss-Schraube	Anahtar Allen Key Inbuss-Schlüssel
			h=H	b	S	Tmax	f	L			
D635	●	2020 2C-R KGMN	20	20	2	18	20	125	2C KGMN KRLY	TC132 M5x20	4 Allen
D636	●	2525 2C-R KGMN	25	25	2	18	25	150		TC134 M6x20	5 Allen
D637	●	2020 3C-R KGMN	20	20	3	20	20	125	3C KGMN KRLY	TC132 M5x20	4 Allen
D638	●	2525 3C-R KGMN	25	25	3	22	25	150		TC134 M6x20	5 Allen
D639	●	2020 4C-R KGMN	20	20	4	20	20	125	4C KGMN KRLY	TC132 M5x20	4 Allen
D640	●	2525 4C-R KGMN	25	25	4	22	25	152		TC134 M6x20	5 Allen

● Stokta/ In Stock / Lager ○ Sınırlı Stok / Limited Stock / Begrenzte Lagerhaltung  
KRLY ucuna uygundur. / Compatible with KRLY insert. / Kompatible für KRLY WP



**D16**  
**ISCR /R**

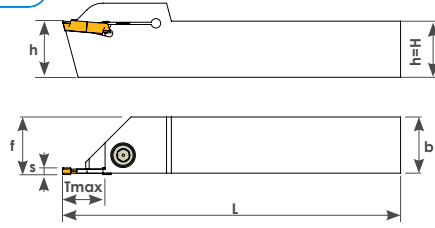

Sipariş Kodu Order Code Best.-Nr.	Stok/Stock/Lager	Ürün Kodu Product Code Produkt-Code	Ölçüler (mm) Dimensions(mm) Abmessungen (mm)						Kullanılan Uç Insert WSP	Sıkma Civatası Clamp Screw Inbuss-Schraube	Anahtar Allen Key Inbuss-Schlüssel
			h=H	b	S	Tmax	f	L			
D750	●	1212 2C-R DGN	12	12	2	15	12	125	2C DGN ISCR	TC132 M5x20	4 Allen
D752	●	1616 2C-R DGN	16	16	2	16	16	125			
D754	●	2020 2C-R DGN	20	20	2	18	20	125			
D756	●	2525 2C-R DGN	25	25	2	19	25	150	3C DGN ISCR	TC134 M6x20	5 Allen
D758	●	1212 3C-R DGN	12	12	3	16	12	125		TC132 M5x20	4 Allen
D760	●	1616 3C-R DGN	16	16	3	19	16	125			
D762	●	2020 3C-R DGN	20	20	3	20	20	125			
D764	●	2525 3C-R DGN	25	25	3	22	25	150	4C DGN ISCR	TC134 M6x20	5 Allen
D775	●	2020 4C-R DGN	20	20	4	20	20	125		TC132 M5x20	4 Allen
D777	●	2525 4C-R DGN	25	25	4	22	25	150	TC134 M6x20		

ISCR ucuna uygundur. / Compatible with ISCR insert. / Kompatible für ISCR WP

**D16**  
**ISCR /L**

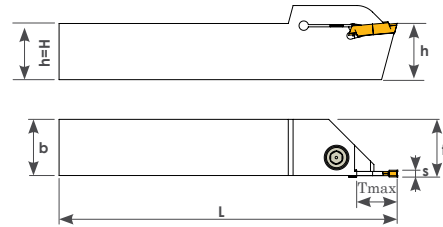

Sipariş Kodu Order Code Best.-Nr.	Stok/Stock/Lager	Ürün Kodu Product Code Produkt-Code	Ölçüler (mm) Dimensions(mm) Abmessungen (mm)						Kullanılan Uç Insert WSP	Sıkma Civatası Clamp Screw Inbuss-Schraube	Anahtar Allen Key Inbuss-Schlüssel
			h=H	b	S	Tmax	f	L			
D726	●	1212 2C-L DGN	12	12	2	15	12	125	2C DGN ISCR	TC132 M5x20	4 Allen
D727	●	1616 2C-L DGN	16	16	2	16	16	125			
D728	●	2020 2C-L DGN	20	20	2	18	20	125			
D730	●	1212-3C-L DGN	12	12	3	16	12	125	3C DGN ISCR	TC132 M5x20	4 Allen
D731	●	1616 3C-L DGN	16	16	3	19	16	125			
D732	●	2020 3C-L DGN	20	20	3	20	20	125			
D733	●	2525 3C-L DGN	25	25	3	22	25	150			

● Stokta / In Stock / Lager ○ Sınırlı Stok / Limited Stock / Begrenzte Lagerhaltung  
ISCR ucuna uygundur. / Compatible with ISCR insert. / Kompatible für ISCR WP



**D17**  
**ZCC/R ZT-D**

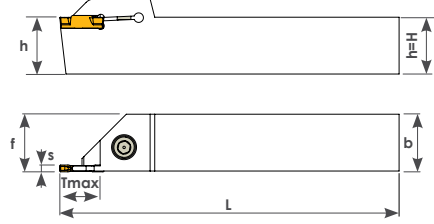

Sipariş Kodu Order Code Best.-Nr.	Stok/Stock/Lager	Ürün Kodu Product Code Produkt-Code	Ölçüler (mm) Dimensions(mm) Abmessungen (mm)						Kullanılan Uç Insert WSP	Sıkma Civatası Clamp Screw Inbuss-Schraube	Anahtar Allen Key Inbuss-Schlüssel
			h=H	b	S	Tmax	f	L			
D027	●	1616 3C-R ZT-D	16	16	3	20	16	125	3C ZT.D ZCC	TC132 M5x20	4 Allen
D028	●	2020 3C-R ZT-D	20	20	3	20	20	125			
D030	●	2525 3C-R ZT-D	25	25	3	22	25	150	4C ZT.D ZCC	TC134 M6x20	5 Allen
D036	●	2020 4C-R ZT-D	20	20	4	18	20	125			
D038	●	2525 4C-R ZT-D	25	25	4	22	25	150	5C ZT.D ZCC	TC132 M5x20	4 Allen
D044	●	2020 5C-R ZT-D	20	20	5	18	20	125			
D046	●	2525 5C-R ZT-D	25	25	5	25	25	150	6C ZT.D ZCC	TC134 M6x20	5 Allen
D049	●	2525 6C-R ZT-D	25	25	6	18	25	150			
D051	●	3232 6C-R ZT-D	32	32	6	19	32	170			

ZCC ucuna uygundur. / Compatible with ZCC insert. / Kompatible für ZCC WP

**D18**  
**TKT /R TD**

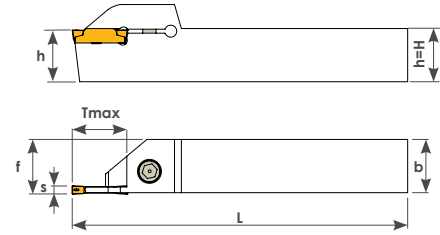
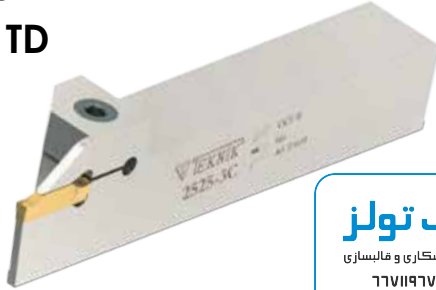

Sipariş Kodu Order Code Best.-Nr.	Stok/Stock/Lager	Ürün Kodu Product Code Produkt-Code	Ölçüler (mm) Dimensions(mm) Abmessungen (mm)						Kullanılan Uç Insert WSP	Sıkma Civatası Clamp Screw Inbuss-Schraube	Anahtar Allen Key Inbuss-Schlüssel
			h=H	b	S	Tmax	f	L			
D714	●	1212 2C-R TD	12	12	2	16	12	125	2C TD TGTC	TC132 M5x20	4 Allen
D715	●	1616 2C-R TD	16	16	2	16	16	125			
D716	●	2020 2C-R TD	20	20	2	16	20	125	3C TD TGTC	TC134 M6x20	5 Allen
D717	●	2525 2C-R TD	25	25	2	18	25	150			
D718	●	1212 3C-R TD	12	12	2	16	12	125	4C TD TGTC	TC132 M5x20	4 Allen
D719	●	1616 3C-R TD	16	16	3	18	16	125			
D720	●	2020 3C-R TD	20	20	3	18	20	125	4C TD TGTC	TC134 M6x20	5 Allen
D721	●	2525 3C-R TD	25	25	3	18	25	150			
D722	●	2020 4C-R TD	20	20	4	18	20	125	4C TD TGTC	TC132 M5x20	4 Allen
D723	●	2525 4C-R TD	25	25	4	18	25	150			

● Stokta / In Stock / Lager ○ Sınırlı Stok / Limited Stock / Begrenzte Lagerhaltung  
TGTCucuna uygundur. / Compatible with TGTCinsert. / Kompatible für TGTCWP

D19  
K-HRN/R S224

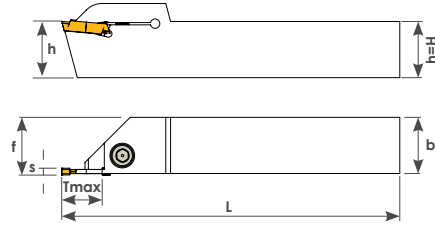

Sipariş Kodu Order Code Best.-Nr.	Stok/Stock/Lager	Ürün Kodu Product Code Produkt-Code	Ölçüler (mm) Dimensions (mm) Abmessungen (mm)						Kullanılan Uç Insert WSP	Sıkma Cıvatası Clamp Screw Inbuss-Schraube	Anahtar Allen Key Inbuss-Schlüssel
			h=H	b	S	Tmax	f	L			
D700	●	1616 2C-R S224	16	16	2	18	16	125	2C S224 K-HRN	TC132 M5x20	4 Allen
D701	●	2020 2C-R S224	20	20	2	18	20	125		TC134 M6x20	5 Allen
D702	●	2525 2C-R S224	25	25	2	18	25	150	3C S224 K-HRN	TC132 M5x20	4 Allen
D703	●	1616 3C-R S224	16	16	3	18	16	100		TC134 M6x20	5 Allen
D704	●	2020 3C-R S224	20	20	3	18	20	125	4C S224 K-HRN	TC132 M5x20	4 Allen
D705	●	2525 3C-R S224	25	25	3	18	25	150		TC134 M6x20	5 Allen
D706	●	2020 4C-R S224	20	20	4	18	20	125	5C S224 K-HRN	TC132 M5x20	4 Allen
D707	●	2525 4C-R S224	25	25	4	18	25	150		TC134 M6x20	5 Allen
D708	●	2020 5C-R S224	20	20	5	18	20	125	5C S224 K-HRN	TC132 M5x20	4 Allen
D710	●	2525 5C-R S224	25	25	5	18	25	150		TC134 M6x20	5 Allen

● Stokta / In Stock / Lager ○ Sınırlı Stok / Limited Stock / Begrenzte Lagerhaltung  
HRN ucuna uygundur. / Compatible with HRN insert. / Kompatible für HRN WP



D20

B-HRN/R S229

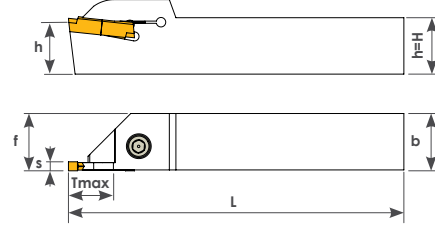

Sipariş Kodu Order Code Best.-Nr.	Stok/Stock/Lager	Ürün Kodu Product Code Produkt-Code	Ölçüler (mm) Dimensions (mm) Abmessungen (mm)						Kullanılan Uç Insert WSP	Sıkma Civatası Clamp Screw Inbuss-Schraube	Anahtar Allen Key Inbuss-Schlüssel
			h=H	b	S	Tmax	f	L			
D688	●	2020 3C-R S229	20	20	3	22	20	125	3C S229 B-HRN	TC132 M5x20	4 Allen
D690	●	2525 3C-R S229	25	25	3	22	25	150		TC134 M6x20	5 Allen
D692	●	2020 4C-R S229	20	20	4	22	20	125	4C S229 B-HRN	TC132 M5x20	4 Allen
D694	●	2525 4C-R S229	25	25	4	22	25	150		TC134 M6x20	5 Allen
D696	●	2020 5C-R S229	20	20	5	22	20	125	5C S229 B-HRN	TC132 M5x20	4 Allen
D698	●	2525 5C-R S229	25	25	5	22	25	150		TC134 M6x20	5 Allen

HRN ucuna uygundur. / Compatible with HRN insert. / Kompatible für HRN WP

D20

B-HRN/L S229

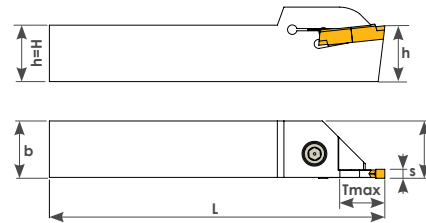

Sipariş Kodu Order Code Best.-Nr.	Stok/Stock/Lager	Ürün Kodu Product Code Produkt-Code	Ölçüler (mm) Dimensions (mm) Abmessungen (mm)						Kullanılan Uç Insert WSP	Sıkma Civatası Clamp Screw Inbuss-Schraube	Anahtar Allen Key Inbuss-Schlüssel
			h=H	b	S	Tmax	f	L			
D711	●	2525 3C-L S229	25	25	3	22	25	150	3C S229 B-HRN	TC134 M6x20	5 Allen
D712	●	2525 4C-L S229	25	25	4	22	25	150			
D713	●	2525 5C-L S229	25	25	5	22	25	150			

HRN ucuna uygundur. / Compatible with HRN insert. / Kompatible für HRN WP

● Stokta/ In Stock / Lager ○ Sınırlı Stok / Limited Stock / Begrenzte Lagerhaltung

**D22**

**SDV 123**

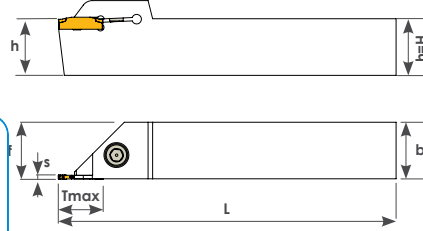

Sipariş Kodu Order Code Best.-Nr.	Stok/Stock/Lager		Ürün Kodu Product Code Produkt-Code	Ölçüler (mm) Dimensions(mm) Abmessungen (mm)						Kullanılan Uç Insert WSP	Sıkma Civatası Clamp Screw Inbuss-Schraube	Anahtar Allen Key Inbuss-Schlüssel
	R	L		h=H	b	S	Tmax	f	L			
D900	●	○	2020 2C-123 SDV	20	20	2	18	20	125	2C 123 SDV	TC132 M5x20	4 Allen
D902	●	○	2525 2C-123 SDV	25	25	2	18	25	150		TC134 M6x20	5 Allen
D904	●	○	2020 3C-123 SDV	20	20	3	18	20	125	3C 123 SDV	TC132 M5x20	4 Allen
D906	●	○	2525 3C-123 SDV	25	25	3	18	25	150		TC134 M6x20	5 Allen
D908	●	○	2020 4C-123 SDV	20	20	4	18	20	125	4C 123 SDV	TC132 M5x20	4 Allen
D910	●	○	2525 4C-123 SDV	25	25	4	18	25	150		TC134 M6x20	5 Allen
D912	●	○	2525 5C-123 SDV	25	25	5	18	25	150	5C 123 SDV		

● Stokta/ In Stock / Lager ○ Sınırlı Stok / Limited Stock / Begrenzte Lagerhaltung  
SNDVK ucuna uygundur. / Compatible with SNDVK insert. / Kompatible für SNDVK WP  
R: Sağ/Right L: Sol/Left

**D23**

**SDV/R 151**

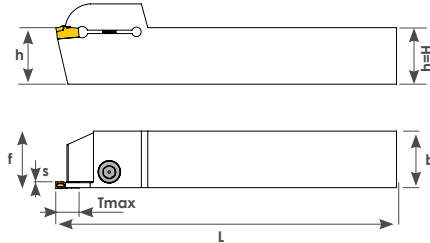

Sipariş Kodu Order Code Best.-Nr.	Stok/Stock/Lager		Ürün Kodu Product Code Produkt-Code	Ölçüler (mm) Dimensions(mm) Abmessungen (mm)						Kullanılan Uç Insert WSP	Sıkma Civatası Clamp Screw Inbuss-Schraube	Anahtar Allen Key Inbuss-Schlüssel
	R	L		h=H	b	S	Tmax	f	L			
D940	●	○	2020 2C-R-151 SDV	20	20	2	16	20	125	2C 151 SDV	TC132 M5x20	4 Allen
D942	●	○	2525 2C-R-151 SDV	25	25	2	16	25	150		TC134 M6x20	5 Allen
D944	●	○	2020 3C-R-151 SDV	20	20	3	16	20	125	3C 151 SDV	TC132 M5x20	4 Allen
D946	●	○	2525 3C-R-151 SDV	25	25	3	16	25	150		TC134 M6x20	5 Allen
D948	●	○	2020 4C-R-151 SDV	20	20	4	18	20	125	4C 151 SDV	TC132 M5x20	4 Allen
D950	●	○	2525 4C-R-151 SDV	25	25	4	18	25	150		TC134 M6x20	5 Allen

● Stokta/ In Stock / Lager ○ Sınırlı Stok / Limited Stock / Begrenzte Lagerhaltung  
SNDVK ucuna uygundur. / Compatible with SNDVK insert. / Kompatible für SNDVK WP



**İç Çap Kanal Kater**  
Grooving Holders  
Stech-Klemmhalter

**تکنیک تولز**  
ابزار آلات صنعتی، تراشکاری و قالبسازی  
۶۶۷۱۷۲۹ - ۶۶۷۱۹۶۷  
تهران، خ امام خمینی، م حسن آباد، پاساژ هشت گنبد، شماره ۱۵

[www.teknikcuttingtools.com](http://www.teknikcuttingtools.com)



## K10 KRLY/R

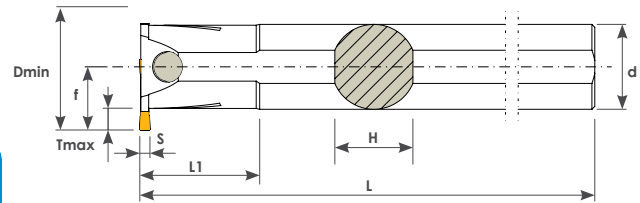
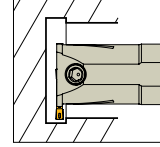

Sipariş Kodu Order Code Best.-Nr.	Stok/Stock/Lager	Ürün Kodu Product Code Produkt-Code	Ölçüler (mm) Dimensions (mm) Abmessungen (mm)								Kullanılan Uç Insert WSP	Sıkma Cıvatası Clamp Screw Inbuss-Schraube	Anahtar Allen Key Inbuss-Schlüssel
			Dmin	Tmax	L	L1	d	h	f	s			
K600	●	S16Q 2C-R MGM	20	4,9	180	35	16	15	12.5	2	2C MGM KRLY	TC130 M5x12	4 Allen
K602	●	S20Q 2C-R MGM	26	5,7	180	35	20	18	15.5	2		TC132 M5x20	
K603	●	S25R 2C-R MGM	31	5,7	200	35	25	23	18.6	2	3C MGM KRLY	TC134 M6x20	5 Allen
K604	●	S20Q 3C-R MGM	25	6	180	35	20	18	15.8	3			
K606	●	S25R 3C-R MGM	31	6,7	200	40	25	23	19	3	4C MGM KRLY	TC132 M5x20	4 Allen
K608	●	S32S 3C-R MGM	37	6,7	250	45	32	30	21.5	3			
K609	●	S40T 3C-R MGM	45	7,4	300	60	40	38	27	3	5C MGM KRLY	TC132 M5x20	4 Allen
K610	●	S20Q 4C-R MGM	25	6	180	35	20	18	15.8	4			
K612	●	S25R 4C-R MGM	31	6	200	40	25	23	19	4	5C MGM KRLY	TC134 M6x20	5 Allen
K614	●	S32S 4C-R MGM	37	6	250	65	32	30	21.5	4			
K616	●	S40T 4C-R MGM	45	7,4	300	60	40	38	27	4	5C MGM KRLY	TC132 M5x20	4 Allen
K618	●	S25R 5C-R MGM	31	7	200	40	25	23	19.4	5			
K620	●	S32S 5C-R MGM	37	7	250	60	32	30	21.5	5	5C MGM KRLY	TC134 M6x20	5 Allen
K622	●	S40T 5C-R MGM	45	7,4	300	60	40	38	27	5			

● Stokta/ In Stock / Lager ○ Sınırlı Stok / Limited Stock / Begrenzte Lagerhaltung  
KRLY ucuna uygundur. / Compatible with KRLY insert. / Kompatible für KRLY WP

**K12**  
**HRN/R S229**

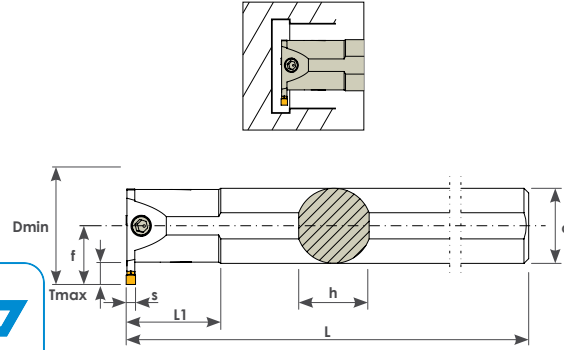
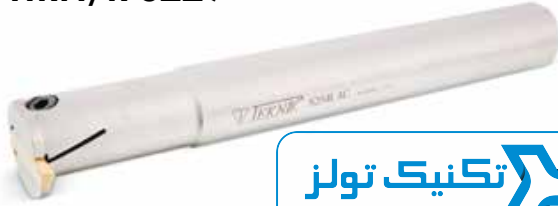

Sipariş Kodu Order Code Code Best.-Nr.	Stok/Stock/Lager	Ürün Kodu Product Code Produkt-Code	Ölçüler (mm) Dimensions(mm) Abmessungen (mm)							Kullanılan Uç Insert WSP	Sıkma Civatası Clamp Screw Inbuss-Schraube	Anahtar Allen Key Inbuss-Schlüssel	
			Dmin	Tmax	L	L1	d	h	f				s
K624	●	S25R 3C-R S229	34	9.8	200	50	25	23	21,5	3	3C S229 HRN	TC132 M5x20	4 Allen
K626	●	S32S 3C-R S229	42	9	250	50	32	30	23,5	3		TC134 M6x20	5 Allen
K628	●	S40T 3C-R S229	49	9	300	60	40	38	28,5	3			
K630	●	S25R 4C-R S229	34	9.5	200	50	25	23	20,5	4	4C S229 HRN	TC132 M5x20	4 Allen
K632	●	S32S 4C-R S229	42	9	250	50	32	30	23,5	4		TC134 M6x20	5 Allen
K634	●	S40T 4C-R S229	49	9	300	60	40	38	28,5	4			
K636	●	S25R 5C-R S229	34	9.5	200	50	25	23	20,5	5	5C S229 HRN	TC132 M5x20	4 Allen
K638	●	S32S 5C-R S229	42	9	250	50	32	30	23,5	5		TC134 M6x20	5 Allen
K640	●	S40T 5C-R S229	49	9	300	60	40	38	28,5	5			

HRN ucuna uygundur. / Compatible with HRN insert. / Kompatible für HRN WP

**K14**  
**SDV/R 123**

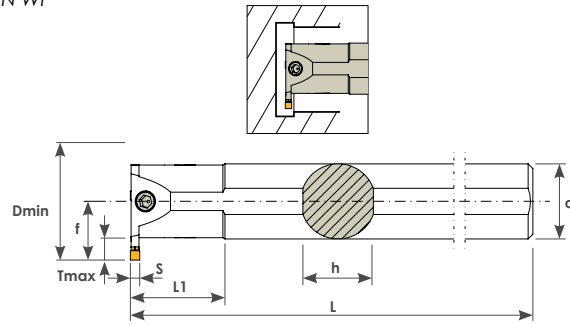

Sipariş Kodu Order Code Code Best.-Nr.	Stok/Stock/Lager	Ürün Kodu Product Code Produkt-Code	Ölçüler (mm) Dimensions(mm) Abmessungen (mm)							Kullanılan Uç Insert WSP	Sıkma Civatası Clamp Screw Inbuss-Schraube	Anahtar Allen Key Inbuss-Schlüssel	
			Dmin	Tmax	L	L1	d	h	f				s
K720	●	S25R 3C-R-123 SDV	32	7	200	40	25	23	19,5	3	3C 123 SNDVK	TC132 M5x20	4 Allen
K722	●	S32S 3C-R-123 SDV	39	7	250	60	32	30	23	3		TC134 M6x20	5 Allen
K726	●	S25R 4C-R-123 SDV	32	7	200	40	25	23	19,5	4	4C 123 SNDVK	TC132 M5x20	4 Allen
K728	●	S32S 4C-R-123 SDV	39	7	250	60	32	30	23	4		TC134 M6x20	5 Allen
K730	●	S25S 5C-R-123 SDV	32	7	200	40	25	23	19,5	5	5C 123 SNDVK	TC132 M5x20	4 Allen
K732	●	S32S 5C-R-123 SDV	39	7	250	60	32	30	19,5	5		TC134 M6x20	5 Allen

● Stokta/ In Stock / Lager ○ Sınırlı Stok / Limited Stock / Begrenzte Lagerhaltung  
SNDVK ucuna uygundur. / Compatible with SNDVK insert. / Kompatible für SNDVK WP

**K16**  
**HRN/R S224**

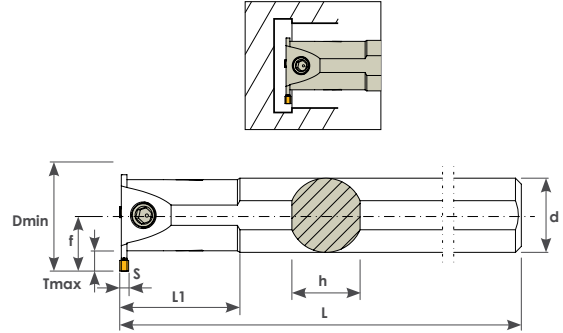

Sipariş Kodu Order Code Best.-Nr.	Stok/Stock/Lager	Ürün Kodu Product Code Produkt-Code	Ölçüler (mm) Dimensions (mm) Abmessungen (mm)								Kullanılan Uç Insert WSP	Sıkma Civatası Clamp Screw Inbuss-Schraube	Anahtar Allen Key Inbuss-Schlüssel
			Dmin	Tmax	L	L1	d	h	f	S			
K642	●	S20Q 2C-R S224	28	6,5	180	40	20	18	15,8	2	2C S224 K.HRN	TC132 M5x20	4 Allen
K644	●	S25R 2C-R S224	34	9	200	50	25	23	20,5	2			
K646	●	S20Q 3C-R S224	28	6,5	180	40	20	18	15,8	3	3C S224 K.HRN	TC134 M6x20	5 Allen
K648	●	S25R 3C-R S224	34	9	200	50	25	23	20,5	3			
K650	●	S32S 3C-R S224	42	9	250	50	32	30	23,5	3	4C S224 K.HRN	TC132 M5x20	4 Allen
K652	●	S20Q 4C-R S224	28	6,5	180	40	20	18	15,8	4			
K654	●	S25R 4C-R S224	34	9	200	50	25	23	20,5	4	TC134 M6x20	5 Allen	
K656	●	S32S 4C-R S224	42	9	250	50	32	30	23,5	4			

HRN ucuna uygundur. / Compatible with HRN insert. / Kompatible für HRN WP

**K18**  
**ZCC/R ZT.D**

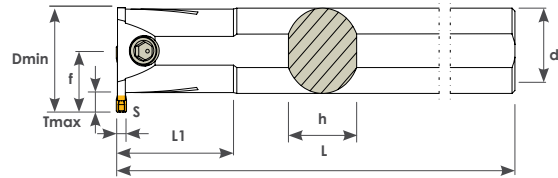
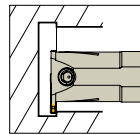

Sipariş Kodu Order Code Best.-Nr.	Stok/Stock/Lager	Ürün Kodu Product Code Produkt-Code	Ölçüler (mm) Dimensions (mm) Abmessungen (mm)								Kullanılan Uç Insert WSP	Sıkma Civatası Clamp Screw Inbuss-Schraube	Anahtar Allen Key Inbuss-Schlüssel
			Dmin	Tmax	L	L1	d	h	f	S			
K680	●	S20Q 3C-R ZT.D	26	5,5	180	45	20	18	15	3	3C ZT.D ZCC	TC132 M5x20	4 Allen
K681	●	S25R 3C-R ZT.D	33	7,5	200	35	25	23	20	3			
K682	●	S32S 3C-R ZT.D	39	7	250	50	32	30	23	3	4C ZT.D ZCC	TC134 M6x20	5 Allen
K684	●	S25R 4C-R ZT.D	33	7,5	200	35	25	23	23	4			
K685	●	S32S 4C-R ZT.D	39	7	250	50	32	30	30	4	TC132 M5x20	4 Allen	
													TC134 M6x20

● Stokta / In Stock / Lager ○ Sınırlı Stok / Limited Stock / Begrenzte Lagerhaltung  
ZCC ucuna uygundur. / Compatible with ZCC insert. / Kompatible für ZCC ZCC WP



**K20  
GRP/R**

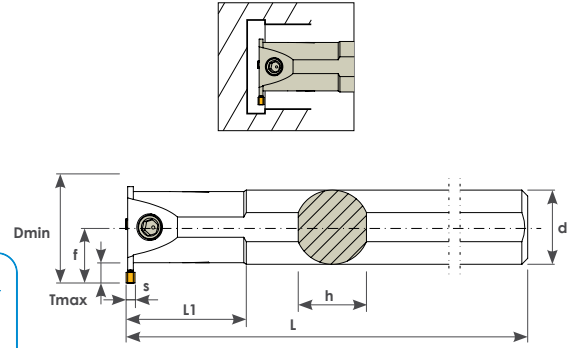

Sipariş Kodu Order Code Best.-Nr.	Stok/Stock/Lager	Ürün Kodu Product Code Produkt-Code	Ölçüler (mm) Dimensions(mm) Abmessungen (mm)								Kullanılan Uç Insert WSP	Sıkma Cıvatası Clamp Screw Inbuss-Schraube	Anahtar Allen Key Inbuss-Schlüssel
			Dmin	Tmax	L	L1	d	h	f	S			
K700	●	S16Q 3C-R GRP	20	4,9	180	45	16	18	12,9	3	3C GRP ISCR	TC130 M5x12	4 Allen
K702	●	S20Q 3C-R GRP	25	6	180	35	20	18	16	3			4 Allen
K704	●	S25R 3C-R GRP	31	6,5	200	35	25	23	19	3		4C GRP ISCR	TC132 M5x20
K706	●	S20Q 4C-R GRP	25	5,5	180	35	20	18	15,5	4	4 Allen		
K708	●	S25R 4C-R GRP	31	6,5	200	35	25	23	19	4	TC134 M6x20		5 Allen
K710	●	S32S 4C-R GRP	37	6,5	250	60	32	30	22,5	4			5 Allen

ISCR ucuna uygundur. / Compatible with ISCR insert. / Kompatible für ISCR WP

**K22  
DGN/R**

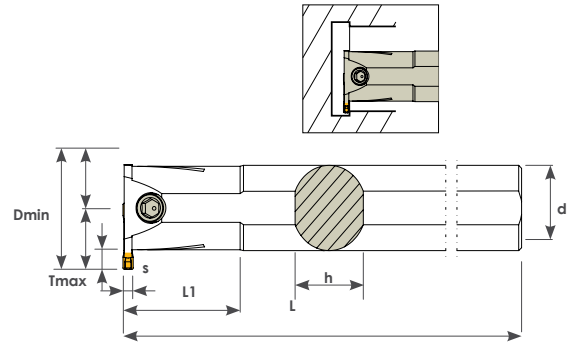

Sipariş Kodu Order Code Best.-Nr.	Stok/Stock/Lager	Ürün Kodu Product Code Produkt-Code	Ölçüler (mm) Dimensions(mm) Abmessungen (mm)								Kullanılan Uç Insert WSP	Sıkma Cıvatası Clamp Screw Inbuss-Schraube	Anahtar Allen Key Inbuss-Schlüssel
			Dmin	Tmax	L	L1	d	h	f	S			
K672	●	S20Q 3C-R DGN	25	5,5	180	35	20	18	15,5	3	3C DGN ISCR	TC132 M5x20	4 Allen
K673	●	S25R 3C-R DGN	31	6	200	40	25	23	18,5	3			5 Allen
K674	●	S32S 3C-R DGN	37	6	250	55	32	30	30	3		4C DGN ISCR	TC132 M5x20
K676	●	S20Q 4C-R DGN	25	5,5	180	35	20	18	18	4	TC134 M6x20		
K677	●	S25R 4C-R DGN	31	6	200	40	25	23	23	4			TC134 M6x20
K678	●	S32S 4C-R DGN	37	6	250	55	32	30	30	4	5 Allen		

● Stokta/ In Stock / Lager ○ Sınırlı Stok / Limited Stock / Begrenzte Lagerhaltung  
ISCR ucuna uygundur. / Compatible with ISCR insert. / Kompatible für ISCR WP

## M10 MİNİ KANAL KATERİ Mini Grooving Holders

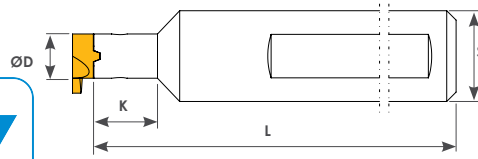
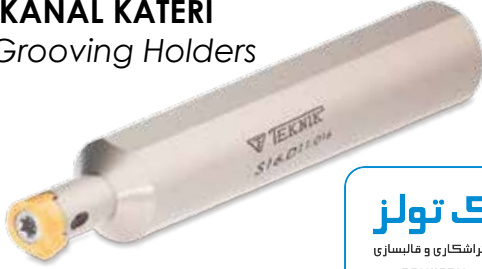

Sipariş Kodu Order Code Best.-Nr.	Stok/Stock/Lager	Ürün Kodu Product Code Produkt-Code	Ölçüler (mm) Dimensions (mm) Abmessungen (mm)				Kullanılan Uç Insert WSP	Sıkma Civatası Clamp Screw Torx-Schraube	Anahtar Torx Key Torx-Schlüssel
			S	D	K	L			
K810	●	S16 D08 K11 L94	16	8	11	94	D08	TC069 M3,5x8,5	T10
K812	●	S16 D09 K20 L94	16	9	20	94	D09	TC074 M4x10	T15
K814	●	S16 D06 K11 L78	16	6	11	78	D06	TC060 M2,5x5,5	T8
K816	●	S20 D14 K49 L160	20	14	49	160	D14	TC074 M4x10	T15

HRN ucuna uygundur. / Compatible with HRN insert. / Kompatible für HRN WP

## M12 DİŞ AÇMA FREZELER Thread Cutting Cutter

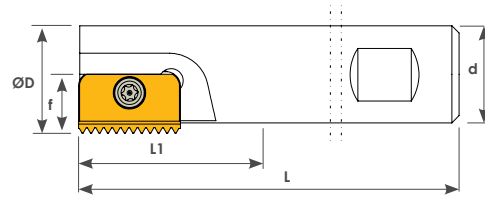

Sipariş Kodu Order Code Best.-Nr.	Stok/Stock/Lager	Ürün Kodu Product Code Produkt-Code	Ölçüler (mm) Dimensions (mm) Abmessungen (mm)						Kullanılan Uç Insert WSP	Sıkma Civatası Clamp Screw Torx-Schraube	Anahtar Torx Key Torx-Schlüssel
			D	Z	L	L1	d	f			
DAF02	●	D12 Z01 L100 C14	12	1	100	40	12	6	C 14 CPT	TC065 M3x7	T8
DAF04	●	D12 Z01 L080 C14	12	1	80	27	20	6			
DAF06	●	D15 Z01 L100 C14	15	1	100	30	12	7,5			
DAF10	●	D21 Z01 L100 C21	21	1	100	47	20	10,5	C 21 CPT	TC075 M4x11	T15
DAF12	●	D18 Z01 L120 C21	18	1	120	50	20	9			
DAF14	●	D29 Z01 L120 C21	29	1	120	50	32	14,5			
DAF16	●	D36 Z02 L120 C21	36	2	120	50	32	18			
DAF18	●	D25 Z01 L150 C21	25	1	150	50	20	12,5			

● Stokta/ In Stock / Lager ○ Sınırlı Stok / Limited Stock / Begrenzte Lagerhaltung  
CPT ucuna uygundur. / Compatible with CPT insert. / Kompatible für CPT WP

**KESKİ KÜTÜĞÜ**  
Block for Blades

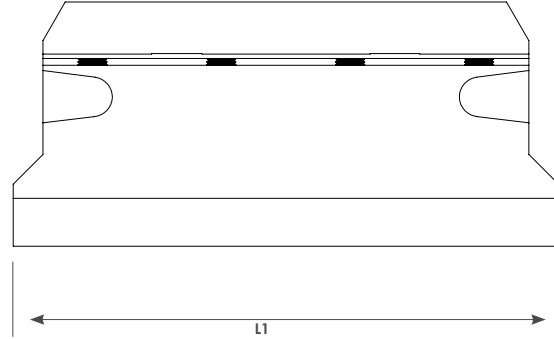
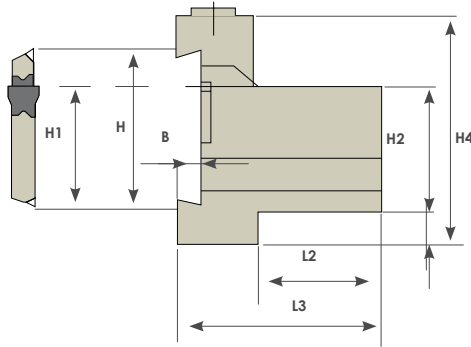

Sipariş Kodu Order Code Best.-Nr.	Stok/Stock/Lager	Ürün Kodu Product Code Produkt-Code	Ölçüler (mm) Dimensions (mm) Abmessungen (mm)								Papuç Clamp Spannpratze	Sıkma Civatası Clamp Screw Inbuss-Schraube	Anahtar Allen Key Inbuss-Schlüssel
			H	H1	H2	H4	B	L1	L2	L3			
KLT 06	●	20-32	32	24,8	20	48	5,5	100	19	35			
KLT 08	●	25-32	32	24,8	25	48	5,5	110	20	36			
KLT 10	●	32-32	32	24,8	32	48	5,5	120	28	44			





**Takım Tutucuları**  
*Tool Holders*  
*Werkzeugaufnahmen*

## ISO 40

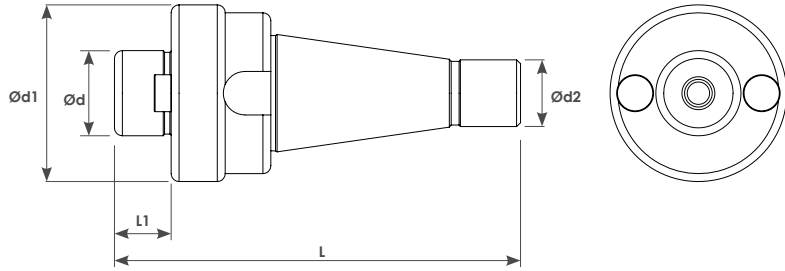

Sipariş Kodu Order Code Best.-Nr.	Stok/Stock/Lager	Ürün Kodu Product Code Produkt-Code	ŞAFT Shank Schaft	Ölçüler (mm) Dimensions (mm) Abmessungen (mm)				
				d	d1	d2	L	L1
M206	●	ISO 40-16	ISO 40	16	39	25	154	17
M208	●	ISO 40-22	ISO 40	22	50	25	154	19
M210	●	ISO 40-27	ISO 40	27	59	25	154	21
M212	●	ISO 40-32	ISO 40	32	66	25	154	24
M214	●	ISO 40-40	ISO 40	40	72	25	154	27

## ISO 50

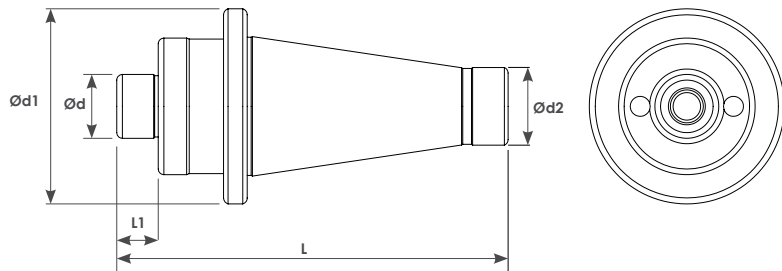

Sipariş Kodu Order Code Best.-Nr.	Stok/Stock/Lager	Ürün Kodu Product Code Produkt-Code	ŞAFT Shank Schaft	Ölçüler (mm) Dimensions (mm) Abmessungen (mm)				
				d	d1	d2	L	L1
M216	●	ISO 50-22	ISO 50	22	52	39,3	196	19
M218	●	ISO 50-27	ISO 50	27	68	39,3	196	21
M220	●	ISO 50-32	ISO 50	32	68	39,3	196	24
M222	●	ISO 50-40	ISO 50	40	98	39,3	196	27
M224	●	ISO 50-60	ISO 50	60	108	39,3	196	26

● Stokta/ In Stock / Lager ○ Sınırlı Stok / Limited Stock / Begrenzte Lagerhaltung

## MK 4 VİDALI

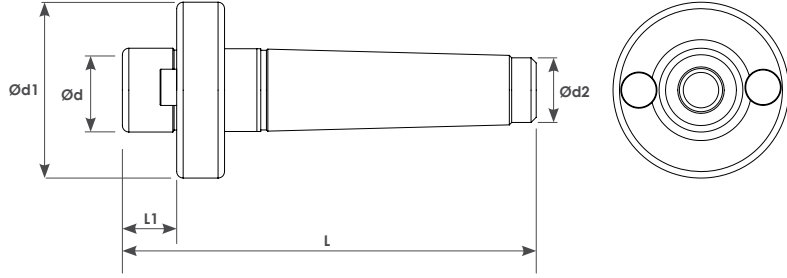

Sipariş Kodu Order Code Best.-Nr.	Stok/Stock/Lager	Ürün Kodu Product Code Produkt-Code	ŞAFT Shank Schaft	Ölçüler (mm) Dimensions (mm) Abmessungen (mm)				
				d	d1	d2	L	L1
M242	●	MK 4-16	MK 4	16	49	25	160	15
M244	●	MK 4-22	MK 4	22	49	25	160	17,5
M246	●	MK 4-27	MK 4	27	58	25	160	17,5
M248	●	MK 4-32	MK 4	32	68	25	160	21

## MK 5 KAMALI

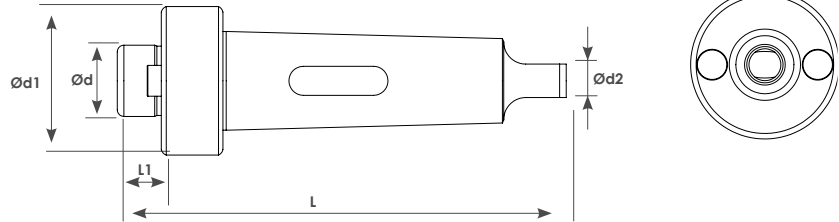

Sipariş Kodu Order Code Best.-Nr.	Stok/Stock/Lager	Ürün Kodu Product Code Produkt-Code	ŞAFT Shank Schaft	Ölçüler (mm) Dimensions (mm) Abmessungen (mm)				
				d	d1	d2	L	L1
M234	●	MK 5-22	MK 5	22	52	15	204	19
M236	●	MK 5-32	MK 5	32	68	15	204	22
M238	●	MK 5-40	MK 5	40	98	15	204	27
M240	●	MK 5-60	MK 5	60	108	15	207	26

● Stokta / In Stock / Lager ○ Sınırlı Stok / Limited Stock / Begrenzte Lagerhaltung



**تکنیک تولز**  
ابزار آلات صنعتی، تراشکاری و ماشینسازی  
۶۶۷۱۱۷۲۹ - ۶۶۷۱۱۹۶۷  
تهران، خ امام خمینی، م حسن آباد، پاساژ هشت گنبد، شماره ۱۵







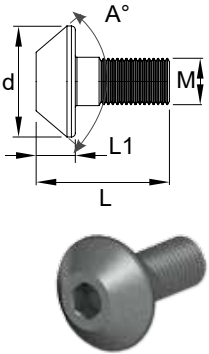
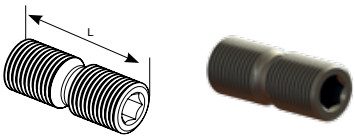
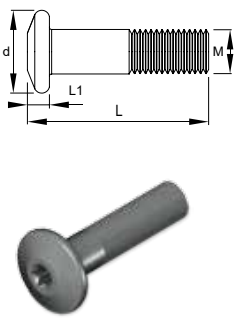
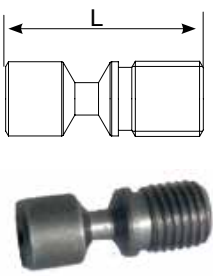
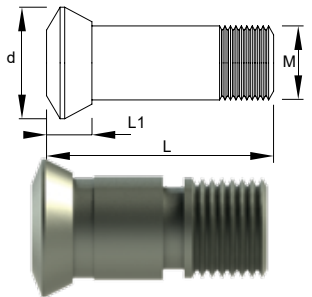



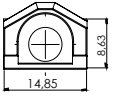

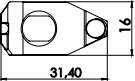

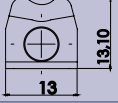

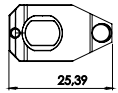



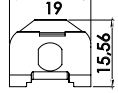



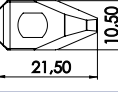

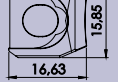
**Yedek Parça**  
Spare Parts  
Zubehör

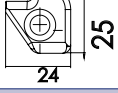

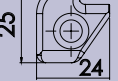

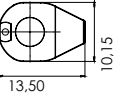

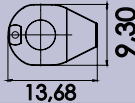

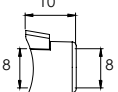
Parça/Part/Zubehör	Kod Code	M	A	d	L	Anahtar/Key Schlüssel
<p><b>Tork Civatası (Sıkma Civata)</b> Torx Screw Torx-Schrauben</p>   <div style="border: 1px solid blue; padding: 5px; text-align: center;"> <p><b>تکنیک تولز</b></p> <p>ابزار آلات صنعتی، تراشکاری و قالبسازی ۶۶۷۱۱۶۶۷ - ۶۶۷۱۱۷۳۹ تهران، خ امام خمینی، م حسن آباد، پاساژ هشت کعبه، شماره ۱۵</p> </div>	TC058	M2x4,2	37°	2,7	4,2	T6
	TC059	M2,2x5	55°	3,2	5	T7
	TC060	M2,5x5,5	60°	3,5	5,5	T8
	TC063	M2,5x7	60°	3,5	7	T8
	TC064	M3x6,5	50°	3,8	6,5	T8
	TC065	M3x7	60°	4,2	7	T8
	TC066	M3x11	40°	4,2	11	T8
	TC067	M3,5x9	60°	5,3	9	T15
	TC068	M3,5x11	60°	5,3	11	T15
	TC069	M3,5x8,5	60°	4,8	8,5	T10
	TC070	M3,5x11	60°	4,8	11	T10
	TC071	M3,5x7	50°	5,5	7	T15
	TC073	M4x7	60°	5,5	7	T15
	TC074	M4x10	60°	5,5	10	T15
	TC075	M4x11	50°	6,1	11	T15
	TC076	M4x12,5	60°	5,5	12,5	T15
	TC077	M4x10	82°	5,8	10	T15
	TC078	M4x11	52°	6,5	11	T15
	TC079	M4x11	38°	5,1	11	T15
	TC080	M4,5x11	45°	6,2	11	T15
TC083	M5x12	50°	7	12	T20	
TC084	M5x13	60°	6,5	13	T20	
TC085	M5x12	75°	6,6	12	T20	
<p><b>Bükse Civata</b> Shim Screw Inbuss-Schlüssel</p>  	TC048	M5x10		6,3	10	4 Allen
	TC049	M5x7			7	3,5 Allen
<p><b>Aflık Civatalar</b> Shim Screw Inbuss-Schlüssel</p>  	TC036	M3x10		5,6	10	T10
	TC038	M4x10	45°	7,30	10	T15
	TC039	M6x12	60°	10,6	12	4 Allen
	TC040	M3,5x10		8	10	T15
	TC095	M5x11,8	60°	9,5	11,8	3 Allen

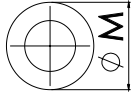

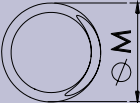

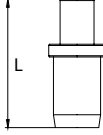

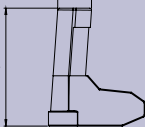



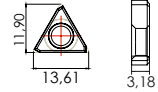



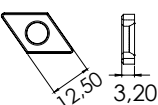



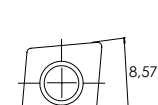

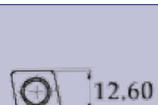

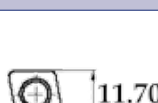



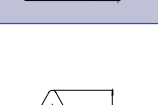

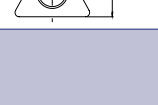







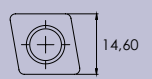

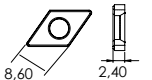



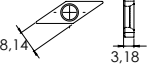

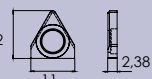

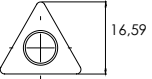



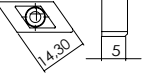

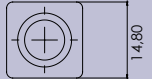
Parça/Part/Zubehör	Kod Code	M	A	d	L	Anahtar/Key Schlüssel
<b>Baski Civatalar</b> Locking Screw Verriegelungsschraub 	TC050	M6x14	70°	11,2	14	3 Allen
	TC052	M6x17	80°	14	17	4 Allen
	TC054	M8x24	80°	17,1	24	5 Allen
	TC056	M8x24 (sol-left)	80°	17,1	24	5 Allen
<b>Baski Civata</b> Locking Screw Verriegelungsschraub 	TC300	M8x18			21	4 Allen
<b>Baski Civata</b> Locking Screw Verriegelungsschraub 	TC044	M6x27		11	27	4 Allen
	TC046	M5x26		10	26	3 Allen
	TC040	M3,5x10		8	10	T15
<b>Baski Civata</b> Locking Screw Verriegelungsschraub 	TH821	M8x21			21	3 Allen
	TH822	M8x22			22	2,5 Allen
	TH613	M6x13,4			13,4	2,5 Allen
	TH617	M6x17			17	2 Allen
	TH512	M5x12			12	2 Allen
	TH-825	M8x25			25	3 Allen
<b>Küre Civatalar</b> Screws For Radius Cutte 	TC170	M3x7		4,2	7	T8
	TC172	M4x9		5,8	9	T15
	TC174	M5x10		7	10	T20
	TC176	M5x12		7,3	12	T20
	TC178	M5x16		7,8	16	3 Allen
	TC181	M6x22		9,5	22	3 Allen
	TC184	M8x25		13	25	4 Allen

**تکنیک تولز**  
ایران آلات صنعتی، تراشکاری و ماشینکاری  
۶۶۷۱۹۶۷ - ۶۶۷۱۷۲۲۹  
تهران، ج امام خمینی، م حسن آباد، پاساژ هشت گنبد، شماره ۱۵

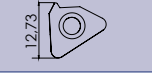
Kod Code	Tipi Type	Parça Part	Ölçüler (mm) Dimensions (mm) Abmessungen (mm)	
			M	
BK017	DNMG 11			
BK018	CNMG 16-19			
BK019	WNMG 06			
BK020	D Type			
BK021	VNMG 16			
BK022	TNMG 16			
BK023	TNMG 22			
BK024	D Type (Small)			
BK026	WNMG 08			
BK028	KNUX Sağ/Right			
BK030	KNUX/Left			
BK035	RDMT 16			
BK036	TPKN16			
BK300	OFCR 07			

Kod Code	Tipi Type	Parça Part	Ölçüler (mm) Dimensions (mm) Abmessungen (mm)				
			M				
BSP010	Baskı Pulu						
BSP030	Baskı Pulu (Normal)						
BSP031	Baskı Pulu						
BY040	M6						
BY041	M5						
BY042	M6						
BY043	M5						
BSP020	TNMG 16 L10-D6						
BSP021	TNMG 22 L15-D7						
BSP024	TNMG 08						
BSP026	TNMG 06						
TL3	L12,2-D3,5						
TL3B	L10-D3						
TL4	L13-D4,5						
TL4A	L10,5-D4,7						
TL4B	L15,6-D5						
TS-3	D6,65-L5,5						
TS-4	D7,71-L7						

Kod Code	Tipi Type	Parça Part	Ölçüler (mm) Dimensions (mm) Abmessungen (mm)
			M
TA010	TPKN 16 ALTLIK		
TA012	TPKN 22 ALTLIK		
TA014	DNMG 15 ALTLIK		
TA014-1	DNMG 15 ALTLIK		
TA015	CCMT 09 ALTLIK		
TA016	CNMG 12 ALTLIK		
TA016-1	CNMG 12 ALTLIK		
TA017	CNMG 19 ALTLIK		
TA019	TNMG 16 ALTLIK		
TA020	WNMG 08 ALTLIK		
TA020-1	WNMG 08 ALTLIK		

Kod Code	Tipi Type	Parça Part	Ölçüler (mm) Dimensions (mm) Abmessungen (mm)
			M
TA021	WNMG 06 ALTLIK		
TA022	CNMG 16 ALTLIK		
TA030	DCMT 11 ALTLIK		
TA032	VCMT 16 ALTLIK		
TA034	VBMT 16 ALTLIK		
TA040	ER 16 ALTLIK		
TA045	TNMG 22 ALTLIK		
TA046	KNUX RIGHT ALTLIK		
TA048	KNUX LEFT ALTLIK		
TA050	SNMG ALTLIK		
TA052	SEET 12 ALTLIK		
TA061	16 ER ALTLIK		
TA062	22 ER ALTLIK		
TA060	16 IR ALTLIK		
TA063	22 IR ALTLIK		



**ÇAPLAR VE Vc HIZINA GÖRE KULLANILAN DEVİRLER n(dev./dk)**  
Diameter and Vc delivery / Durchmesser und die Vc Zustellung

**ÇAPLAR**  
Bore diameter / Durchmesser

VC HIZI m/dk	10	12	14	16	18	20	22	24	26	28	30	32	34	36	38	40	42	44	46	48	50	63	80	100
50	1606	1327	1137	995	885	796	724	663	612	569	531	498	468	442	419	398	379	362	346	332	318	253	199	159
60	1927	1592	1365	1194	1062	955	869	796	735	682	637	597	562	531	503	478	455	434	415	398	382	303	239	191
70	2248	1858	1592	1393	1238	1115	1013	929	857	796	743	697	656	619	587	557	531	507	485	464	446	354	279	223
80	2569	2123	1820	1592	1415	1274	1158	1062	980	910	849	796	749	708	670	637	607	579	554	531	510	404	318	255
90	2890	2389	2047	1791	1592	1433	1303	1194	1102	1024	955	896	853	796	754	717	682	651	623	597	573	455	358	287
100	3211	2654	2275	1990	1769	1592	1448	1327	1225	1137	1062	995	937	885	838	796	758	724	692	663	637	506	398	318
110	3532	2919	2502	2189	1946	1752	1592	1460	1347	1251	1168	1095	1030	973	922	876	834	796	762	730	700	556	438	350
120	3854	3185	2730	2389	2123	1910	1737	1592	1470	1365	1274	1194	1124	1062	1006	955	910	869	831	796	764	607	478	382
130	4175	3450	2957	2588	2300	2070	1882	1725	1592	1479	1380	1294	1218	1150	1090	1035	986	941	900	863	828	657	518	414
140	4496	3715	3185	2787	2477	2229	2027	1858	1715	1592	1486	1393	1311	1238	1173	1115	1062	1013	969	929	892	708	557	446
150	4817	3981	3412	2986	2654	2389	2171	1990	1837	1706	1592	1493	1405	1327	1257	1194	1137	1086	1038	995	955	758	597	478
160	5138	4246	3640	3185	2831	2548	2316	2143	1960	1820	1699	1592	1499	1415	1341	1274	1213	1158	1108	1062	1019	809	637	510
170	5459	4512	3867	3384	3008	2707	2461	2256	2082	1934	1805	1692	1592	1504	1425	1354	1289	1230	1177	1128	1083	859	677	541
180	5780	4777	4095	3583	3185	2866	2606	2389	2205	2047	1911	1791	1686	1592	1509	1433	1365	1303	1246	1194	1146	910	717	573
190	6101	5042	4322	3782	3362	3025	2750	2521	2327	2161	2017	1891	1780	1681	1592	1513	1441	1375	1315	1261	1210	960	756	605
200	6423	5308	4550	3981	3539	3185	2895	2654	2450	2275	2123	1990	1873	1769	1676	1592	1517	1448	1385	1327	1274	1011	796	637
210	6744	5573	4777	4180	3715	3344	3040	2787	2572	2389	2229	2090	1967	1858	1760	1672	1592	1520	1454	1393	1138	1062	836	669
220	7065	5839	5005	4379	3892	3503	3185	2919	2695	2502	2335	2189	2061	1946	1844	1752	1668	1592	1523	1460	1401	1112	876	701
230	7386	6104	5232	4578	4069	3662	3329	3052	2817	2616	2442	2289	2154	2035	1928	1831	1744	1665	1592	1526	1465	1163	916	732
240	7707	6369	5460	4777	4246	3822	3474	3185	2940	2730	2548	2389	2248	2123	2011	1911	1820	1737	1662	1592	1529	1213	955	764
250	8028	6635	5687	4976	4423	3981	3619	3317	3062	2843	2654	2488	2342	2212	2095	1990	1896	1809	1731	1659	1592	1264	995	1592

## TORNALAMA İÇİN FORMÜLLER

Formulas for turning / Formeln für Drehen

$$\text{DEVİR SAYISI} = n = \frac{Vc \times 1000}{\pi \times D} \text{ devir / dakika}$$

Revolutions / Umdrehungen      Revs / min.  
Umdrehungen / min.

**n : Devir Sayısı (dev./dak.)**  
Revolutions / Umdrehungen      Revs/ min.  
Umdrehungen/ min.

**n : Devir Sayısı (dev./dak.)**  
Cutting Speed / Schnittgeschwindigkeit (Meter/ min.)

$$\text{KESME HIZI} = Vc = \frac{\pi \times D \times n}{1000} \text{ metre / dakika}$$

Cutting speed      meter / min.  
Schnittgeschwindigkeit

**D : İş Parçasının Çapı (mm)**  
Workpiece diametre / Werkstückdurchmesser

**π: Sabit Sayı (3,14)**  
Constant (3,14) / Gleich bleibend (3,14)

## TORNALAMADA İŞLEME ZAMANININ HESAPLANMASI

Formulas for turning time / Formeln für Drehen Zeiten

$$\text{Çap Tornalamada} = th = \frac{L \times Ps}{n \times f} \text{ dakika}$$

Urning diametre      minute  
Drehdurchmesser

**Ps : Paso Sayısı (kaç defa'da)**  
no of passes / Durchgänge

**th : İşleme Zamanı (dakika)**  
Processing Time / Bearbeitungszeit (min)

**f : İlerleme (mm)**  
Length delivery / Stirn Zustellung (mm)

$$\text{Alın Tornalama} = th = \frac{d \times \pi \times L \times Ps}{Vc \times 1000 \times f} \text{ dakika}$$

Length turning / Stirn Drehen      minute

**Alın Tornalama için Boy**  
Length head turning / Länge für Stirn Drehen  
 $L = \frac{d1 - d2}{2} \text{ mm}$

**Dolu Malzemede Alın Tornalama**  
Solid Stock front turning / Massive Werkstücke Stirn Drehen  
 $L = \frac{d}{2} \text{ mm}$

## YÜZEY FREZELEMEDE KULLANILAN FORMÜLLER

Cutting Recommendations for Milling / Schnitt - Empfehlungen zum Fräsen

$$\text{DEVİR SAYISI} = n = \frac{Vc \times 1000}{\pi \times D} \text{ devir / dakika}$$

Revolutions / Umdrehungen      Revs / min.  
Umdrehungen / min.

**z : Frezenin Ağız Sayısı (adet)**  
Number of tooth / Anzahl Schneiden

**k : Disk Frezenin Etkif Ağız sayısı (adet)**  
Effective edge of the cutter / Effektive Schneiden des Fräasers

$$\text{KESME HIZI} = Vc = \frac{\pi \times D \times n}{1000} \text{ metre / dakika}$$

Cutting speed      meter / min.  
Schnittgeschwindigkeit

**fz : Ağız Başına İlerleme (mm/ağız)**  
Delivery per cutting mm/Z / Zustellung pro Schneide mm/Z

$$\text{TABLA İLERLEMESİ} = Vf = n \times z \times fz \text{ mm / dak}$$

Delivery / Zustellung      mm / min.

**th : İşleme Zamanı (dak.)**  
Processing time / Bearbeitungszeit minute

**th : İşleme Zamanı (dak.)**  
Processing time / Bearbeitungszeit minute

### HASSAS DELİK İŞLEME BARALARI İÇİN

#### Cutting Data for finis Boring tools / Schnittdaten für Fein Ausdrehwerk-zeuge

	Malzeme / Material	HB	Vc	D 9-14	D 14-24	D 22-32	D 28-44	D 36-56	D 50-82	D 80-130
ÇELİKLER Stahl / Stahl	<b>Karbonsuz</b> Low carbon Steel / C-Stahl	80-125	120-180	0.04-0.08	0.05-0.10	0.06-0.11	0.05-0.13	0.05-0.15	0.06-0.15	0.08-0.20
	<b>Düşük Karbonlu</b> Low carbon Steel / C-Stahl	180-280	120-170	0.03-0.08	0.05-0.08	0.06-0.10	0.06-0.13	0.06-0.15	0.08-0.15	0.10-0.20
	<b>Düşük Alaşımli</b> Low alloy Steel / Niderig legiettre Stahl	140-275	120-160	0.02-0.08	0.04-0.08	0.05-0.10	0.08-0.13	0.08-0.15	0.08-0.15	0.10-0.15
	<b>Yüksek Alaşım</b> High alloy Steel / Hoch legiettre Stahl	220-325	130-160	0.02-0.08	0.03-0.08	0.05-0.10	0.06-0.13	0.06-0.5	0.06-0.15	0.10-0.15
	<b>Paslanmaz</b> Austenite / Niro autenitisch (rostfrei)	135-275	110-150	0.03-0.04	0.04-0.07	0.04-0.07	0.05-0.10	0.05-0.13	0.05-0.15	0.10-0.15
	<b>Döküm</b> Grey cast iron / Grauguss	150-260	90-180	0.03-0.08	0.04-0.06	0.04-0.10	0.08-0.12	0.08-0.15	0.10-0.15	0.10-0.15
	<b>Alüminyum</b> Aluminium	30-150	130-230	0.03-0.10	0.05-0.10	0.05-0.13	0.07-0.15	0.07-0.15	0.10-0.15	0.10-0.15

### KABA DELİK İŞLEME BARALARI İÇİN

#### Cutting Data for Boring tools for rough machining / Schnittdaten für Universal Ausbohröpfe

	Malzeme / Material	HB	Vc	D 9-14	D 14-24	D 22-32	D 28-44	D 36-56	D 50-82	D 80-130
ÇELİKLER Stahl / Stahl	<b>Karbonsuz</b> Low carbon Steel / C-Stahl	80-125	120-180	0.05-0.10	0.05-0.12	0.10-0.15	0.10-0.20	0.10-0.22	0.10-0.25	0.10-0.25
	<b>Düşük Karbonlu</b> Low carbon Steel / C-Stahl	180-280	120-160	0.05-0.10	0.05-0.12	0.10-0.15	0.10-0.20	0.10-0.22	0.10-0.25	0.10-0.25
	<b>Düşük Alaşımli</b> Low alloy Steel / Niderig legiettre Stahl	140-275	120-160	0.05-0.10	0.05-0.10	0.10-0.15	0.10-0.20	0.10-0.22	0.10-0.25	0.10-0.25
	<b>Yüksek Alaşım</b> High alloy Steel / Hoch legiettre Stahl	220-325	130-160	0.05-0.10	0.05-0.10	0.10-0.20	0.10-0.20	0.10-0.20	0.10-0.25	0.10-0.25
	<b>Paslanmaz</b> Austenite / Niro autenitisch (rostfrei)	135-275	110-150	0.05-0.10	0.07-0.10	0.08-0.12	0.10-0.20	0.10-0.20	0.10-0.25	0.10-0.25
	<b>Döküm</b> Grey cast iron / Grauguss	150-260	90-180	0.08-0.10	0.084-0.10	0.10-0.20	0.10-0.20	0.10-0.25	0.10-0.25	0.10-0.25
	<b>Alüminyum</b> Aluminium	30-150	150-220	0.08-0.12	0.10-0.15	0.10-0.15	0.10-0.20	0.10-0.25	0.10-0.25	0.10-0.25

### 3D U-DRILL' LER İÇİN

#### Cutting Data for 3XD Insert Drills / Schnittdaten für 3xD Vollbohrer

	Malzeme / Material	HB	Vc	D 13-15	D 16-24	D 25-32	D 33-40	D 41-56	
ÇELİKLER Stahl / Stahl	<b>Karbonsuz</b> Low carbon Steel / C-Stahl	<0.15%C 0.15-0.45%C	80-170	120-220	0.04-0.08	0.05-0.10	0.05-0.10	0.04-0.10	0.08-0.12
	<b>Düşük Karbonlu</b> Low carbon Steel / C-Stahl	>=0.45%C	180-280	80-180	0.04-0.08	0.04-0.10	0.05-0.12	0.08-0.15	0.10-0.20
	<b>Düşük Alaşımli</b> Low alloy Steel / Niderig legiettre Stahl		140-275	70-150	0.04-0.10	0.06-0.13	0.01-0.18	0.11-0.20	0.13-0.25
	<b>Yüksek Alaşım</b> High alloy Steel / Hoch legiettre Stahl		220-325	30-150	0.04-0.08	0.04-0.10	0.06-0.12	0.08-0.14	0.10-0.18
	<b>Paslanmaz</b> Austenite / Niro autenitisch (rostfrei)		135-275	50-130	0.04-0.08	0.04-0.10	0.06-0.12	0.08-0.14	0.10-0.18
			135-275	60-150	0.04-0.08	0.04-0.12	0.06-0.14	0.08-0.18	0.12-0.20
	<b>Döküm</b> Grey cast iron / Grauguss		150-220	130-220	0.04-0.12	0.06-0.14	0.08-0.18	0.10-0.20	0.12-0.25
	<b>Alüminyum</b> Aluminium		30-150	150-280	0.04-0.12	0.06-0.14	0.08-0.16	0.10-0.20	0.12-0.25

ISO	Malzeme / Material	HB	Malzeme No.	DIN	TS	ABD AISI/SAE
<b>P</b> ÇELİKLER Steel / Stahl	<b>Alaşımsız Çelikler</b> Low carbon Steel C-Stahl  %C0,05-0,25	80 - 170	1.0116	St 37-3	St 37-3	A 573-81 65
			1.0401	C15	C15	1015
			1.0402	C22	C22	1020
			1.0715	9SMn28	9SMn28	1213
			1.0718	9SMnPb28	9SMnPb28	12L13
			1.0722	10SPb20	10SPb20	-
	1.0736	9SMn36	9SMn36	1215		
	1.0737	9SMnPb36	9SMnPb36	12L14		
	1.1141	Ck15	Ck15	1015		
	1.1158	Ck25	Ck25	1025		
	%C0,25-0,55	125-225	1.0501	C35	C35	1035
			1.0503	C45	C45	1045
1.0726			35S20	35S20	1140	
1.1157			40Mn4	40Mn4	1039	
1.1167			36Mn5	36Mn5	1335	
1.1170			28Mn6	28Mn6	1330	
1.1191	Ck 45	Ck 45	1045			
%C0,55-0,80	150-225	1.0535	C 55	C 55	1055	
		1.1203	Ck 55	Ck 55	1055	
		1.1221	Ck 60	Ck 60	1060	
		1.0841	St52-3	St52-3	5120	
		1.0961	60SiCr7	60SiCr7	9262	
		1.3505	100Cr6	100Cr6	52100	
<b>M</b> PASLANMAZ Austenitic / Roestfrei	<b>Düşük Alaşımlı Çelikler</b> Low alloy Steel Niderig legiettre Stahl	140 - 275	1.6523	21NiCrMo2	21NiCrMo2	8620
			1.6546	40NiCrMo22	40NiCrMo22	8740
			1.7131	16MnCr5	16MnCr5	5115
			1.6582	35CrNiMo6	35CrNiMo6	4340
			1.7035	41Cr4	41Cr4	5140
			1.7218	25CrMo4	25CrMo4	4130
	1.7225	42CrMo4	42CrMo4	4140		
	1.8159	50CrV4	50CrV4	6150		
	<b>Yüksek Alaşımlı Çelikler</b> High alloy Steel Hoch legiettre Stahl	220 - 325	1.2080	X210Cr12	X210Cr12	D3
			1.2344	X40CrMoV51	X40CrMoV51	H13
			1.3343	S6-5-2	S6-5-2	D3
			1.2379	X210Cr12G	X210Cr12G	HNV3
1.4350			X5CrNi189	X5CrNi189	304	
1.4401			X5CrNiMo18-10	X5CrNiMo18-10	316	
1.4845	X12CrNi25-21	X12CrNi25-21	310S			
<b>K</b> DÖKÜM Cast iron / Guss	<b>Öztenitik Malzemeler Austenite</b>	135 - 175	1.4000	X7Cr13	X7Cr13	403
			1.4005	X12CrS13	X12CrS13	416
			1.4006	X10Cr13	X10Cr13	410
<b>Z</b> ALÜMİNYUM Aluminium	<b>Gri Dökme Demirler</b> Grey cast iron Grauguss	150 - 220	0.6015	GG15	GG15	No25B
			0.6020	GG20	GG20	No30B
			0.6025	GG25	GG25	No35B
			0.6030	GG30	GG30	No45B
			0.6035	GG35	GG35	No50B
			<b>Temper Döküm</b> Malleble cast iron Temperguss	150 - 250	0.8145	GTS45
0.8155	GTS50	GTS50			50005	
<b>Sfero Dökme Demirler</b> Spheroidal cast iron Sphäroguss	180 - 260	0.7040	GGG40	GGG40	60-40-18	
		0.7050	GGG50	GGG50	80-85-06	
		0.7070	GGG70	GGG70	100-70-03	
<b>Alüminyum Alaşımları</b> Aluminium alloy Aluminium Legierungen	30 - 150	3.0255	AL99,5	AL99,5	1000	
		3.2315	ALMgSi1	ALMgSi1	-	
<b>Özel Alaşımlar</b> Special Alloys Sonder Legierungen	30 - 150	3.1325	ALMg1	ALMg1	2024	
		3.3245	ALMg3Si	ALMg3Si	-	

1	2	3			4
Kesici Uç Tipi Cutting Style Plattenform	Uç Açısı Clearance Angle Fräswinkel	Uç Toleransları Tolerance Toleranz			Kesici Uç Delik Tipi Type of Insert Plattentyp
		<b>Sembol</b>	<b>m (+)</b>	<b>s (+)</b>	<b>d (+)</b>
		<b>A</b>	<b>0,005</b>	<b>0,025</b>	<b>0,025</b>
		<b>F</b>	<b>0,005</b>	<b>0,025</b>	<b>0,013</b>
		<b>C</b>	<b>0,013</b>	<b>0,025</b>	<b>0,025</b>
		<b>H</b>	<b>0,013</b>	<b>0,025</b>	<b>0,013</b>
		<b>E</b>	<b>0,025</b>	<b>0,025</b>	<b>0,025</b>
		<b>G</b>	<b>0,025</b>	<b>0,130</b>	<b>0,05-0,013</b>
		<b>J</b>	<b>0,005</b>	<b>0,025</b>	<b>0,05-0,013</b>
		<b>K</b>	<b>0,013</b>	<b>0,025</b>	<b>0,05-0,013</b>
		<b>L</b>	<b>0,025</b>	<b>0,025</b>	<b>0,05-0,013</b>
<b>M</b>	<b>0,08-0,18</b>	<b>0,130</b>	<b>0,05-0,013</b>		
<b>N</b>	<b>0,08-0,18</b>	<b>0,025</b>	<b>0,05-0,013</b>		
<b>U</b>	<b>0,05-0,38</b>	<b>0,130</b>	<b>0,08-0,025</b>		

**تکنیک تولز**

ابزار آلات صنعتی، تراشکاری و قالبسازی  
۶۶۷۱۱۷۲۹ - ۶۶۷۱۱۹۶۷  
تهران، خ امام خمینی، م حسن آباد، پاساژ هشت کبک، شماره ۱۵

**T P K N 22 04 08 F R**

5	6	7	8			
Kesme Kenar Uzunluğu Length of Cutting Edge Schneiden länge	Uç Kalınlığı Height of Cutting Edge Schneidkantenhöhe	Uç Radüsü Chamfer of Corner Radius Planfase oder Eckenradius	Kesme Kenarı Şekli Insert Forms WSP-FORM			
			Keskin Açılı Yuvarlatılmış Açılı			
			<b>Sembol</b>	<b>S</b>	<b>Sembol</b>	<b>m (+)</b>
			<b>01</b>	<b>1,59</b>	<b>00</b>	<b>0</b>
			<b>T1</b>	<b>1,98</b>	<b>02</b>	<b>0,2</b>
			<b>02</b>	<b>2,38</b>	<b>04</b>	<b>0,4</b>
			<b>T2</b>	<b>2,58</b>	<b>08</b>	<b>0,8</b>
			<b>03</b>	<b>3,18</b>	<b>12</b>	<b>1,2</b>
			<b>T3</b>	<b>3,97</b>	<b>16</b>	<b>1,6</b>
			<b>04</b>	<b>4,76</b>	<b>24</b>	<b>2,4</b>
			<b>05</b>	<b>5,56</b>	<b>32</b>	<b>3,2</b>
<b>06</b>	<b>6,35</b>					
<b>07</b>	<b>7,94</b>					
<b>09</b>	<b>9,52</b>					
<b>9</b> <b>İlerleme Yönü</b> Bearbeitung Spichtung Hand of Tool						



1	2	3			4
Kesici Uç Tipi Cutting Style Plattenform	Uç Açısı Clearance Angle Fräswinkel	Uç Toleransları Tolerance Toleranz			Kesici Uç Delik Tipi Type of Insert Plattentyp
		<b>Sembol</b>	<b>m (+)</b>	<b>s (+)</b>	<b>d (+)</b>
		<b>A</b>	<b>0,005</b>	<b>0,025</b>	<b>0,025</b>
		<b>F</b>	<b>0,005</b>	<b>0,025</b>	<b>0,013</b>
		<b>C</b>	<b>0,013</b>	<b>0,025</b>	<b>0,025</b>
		<b>H</b>	<b>0,013</b>	<b>0,025</b>	<b>0,013</b>
		<b>E</b>	<b>0,025</b>	<b>0,025</b>	<b>0,025</b>
		<b>G</b>	<b>0,025</b>	<b>0,130</b>	<b>0,05-0,013</b>
		<b>J</b>	<b>0,005</b>	<b>0,025</b>	<b>0,05-0,013</b>
		<b>K</b>	<b>0,013</b>	<b>0,025</b>	<b>0,05-0,013</b>
		<b>L</b>	<b>0,025</b>	<b>0,025</b>	<b>0,05-0,013</b>
		<b>M</b>	<b>0,08-0,18</b>	<b>0,130</b>	<b>0,05-0,013</b>
		<b>N</b>	<b>0,08-0,18</b>	<b>0,025</b>	<b>0,05-0,013</b>
<b>U</b>	<b>0,05-0,38</b>	<b>0,130</b>	<b>0,08-0,025</b>		











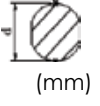



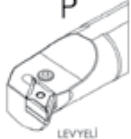































**تکنیک تولز**

ابزار آلات صنعتی، تراشکاری و قالبسازی  
۶۶۷۱۱۶۶ - ۶۶۷۱۱۶۹  
تهران، خ امام خمینی، م حسن آباد، پاساژ هشت گنبد، شماره ۱۵

**D N M G 15 06 08 HR**

















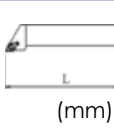



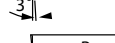

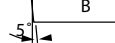

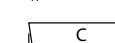

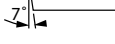

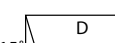

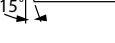

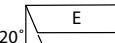









5	6	7		8	
Kesme Kenar Uzunluğu Length of Cutting Edge Schneidenlänge	Uç Kalınlığı Height of Cutting Edge Schneidkantenhöhe	Uç Radüsü Chamfer of Corner Radius Planfase oder Eckenradius		Kesme Kenarı Şekli Insert Forms WSP-FORM	
		<b>Sembol</b>	<b>S</b>	<b>Sembol</b>	<b>m (+)</b>
		<b>01</b>	<b>1,59</b>	<b>00</b>	<b>0</b>
		<b>T1</b>	<b>1,98</b>	<b>02</b>	<b>0,2</b>
		<b>02</b>	<b>2,38</b>	<b>04</b>	<b>0,4</b>
		<b>T2</b>	<b>2,58</b>	<b>08</b>	<b>0,8</b>
		<b>03</b>	<b>3,18</b>	<b>08</b>	<b>1,2</b>
		<b>T3</b>	<b>3,97</b>	<b>12</b>	<b>1,6</b>
		<b>04</b>	<b>4,76</b>	<b>16</b>	<b>2,4</b>
		<b>05</b>	<b>5,56</b>	<b>24</b>	<b>3,2</b>
		<b>06</b>	<b>6,35</b>	<b>32</b>	
<b>07</b>	<b>7,94</b>				
<b>09</b>	<b>9,52</b>				
<b>9</b> <b>Uç Formları</b> Insert Forms WSP-Forml					

**S 3 2 T D D U N R 1 5**

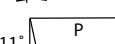
1	2	3	4	5	6	7	8	9		
<b>Takım Malzemesi</b> Type of Shank Schaffansführung	<b>Şaft Genişliği</b> Ø Shank Ø Schaft	<b>Takım Boyu</b> Tool Length Werkzeuglänge	<b>Uç Bağlama Sistemi</b> Clamping System Klemmsystem	<b>Kesici Uç Tipi</b> Insert Form WSP-Form	<b>Kater Tipi</b> Tool Type Shank Werkzeugtyp	<b>Uç Açısı</b> Inser Clearance WSP-Freiwinkel	<b>Kenar Yönü</b> Holder Execution Bearbeitungsrichtung	<b>Uç Kenar Uzunluğu</b> Cutting Edge WSP-Grösse		
<b>A: Çelik Gövdeli İçten Sogutmalı</b> Coolan Through Steel Shank Mit Kühlbohrung	 (mm)	 (mm)	 D ÇEKİRMELİ   M BAŞKI PABAÇLI   P LEVYELİ   S VEDALİ	A  B  C  D  E  H  K  L  M  O  P  R  S  T  V  W 	F  L  Q  S  U  W  Z  X 	3° 5° 7° 15° 20° 25° 30° 11°	<b>R</b> 	A  B  C  D  E  K  L  M  O  P  R  S  T  V  W 		
	<b>06 = 6</b>	<b>D = 60</b>							<b>10 = 10</b>	<b>F = 80</b>
	<b>08 = 8</b>	<b>E = 70</b>							<b>12 = 12</b>	<b>G = 90</b>
	<b>14 = 14</b>	<b>H = 100</b>							<b>16 = 16</b>	<b>J = 110</b>
	<b>20 = 20</b>	<b>K = 125</b>							<b>22 = 22</b>	<b>L = 140</b>
	<b>25 = 25</b>	<b>M = 150</b>							<b>32 = 32</b>	<b>N = 160</b>
	<b>40 = 40</b>	<b>P = 170</b>							<b>50 = 50</b>	<b>Q = 180</b>
		<b>R = 200</b>								
		<b>S = 250</b>								
		<b>T = 300</b>								
	<b>U = 350</b>									
	<b>V = 400</b>									
	<b>W = 450</b>									
	<b>Y = 500</b>									
	<b>X = ÖZEL Special Sonderform</b>									
<b>C: Toz Metal Gövdeli İçten Sogutmalı</b> Hardmetal Shank Hartmetall Stahlkopf										
<b>E: Toz Metal Gövdeli İçten Sogutmalı</b> Hardmetal Shank With Coolant Hole Hartmetall Schaff- mit Stahlkopf und Kühlbohrung										
<b>S: Çelik Gövdeli</b> Steel Shank Stahl Schaft										

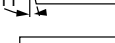
**TEKNİK TOLUZ**  
ایزار آلات صنعتی، تراشکاری و ماشینکاری  
۱۵ شماره شهر، تهران، م. ح. ج. آباد، پاساژ هشت گنبد، شماره ۱۵  
۶۶۷۱۹۶۷ - ۶۶۷۱۷۲۶

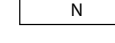
**D D J N R 20 20 K 15**

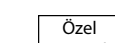
1	2	3	4	5	6	7	8	9				
Uç Bağlama Sistemi Clamping System Klemmsystem	Kesici Uç Tipi Cutting Style Plattenform	Kater Tipi Type Werkzeugtyp	Uç Açısı Clearance angle WSP-Freiwinkel	Kater Yönü Holder Execution Bearbeitungsrichtung	Şaft Yüksekliği Height of Shank Schaftquerschnitts	Şaft Genişliği Width of Shank Schaltbreite	Takım Boyu Leng of Holder Werkzeuflänge	Uç Kenar Uzunluğu Lenght of Cutting Edge WSP-Grösse				
	A 	A 	A 									
	B 	B 	B 						06 = 6	06 = 6	D = 60	
	C 	C 	C 						08 = 8	08 = 8	E = 70	
	D 	D 	D 						10 = 10	10 = 10	F = 80	
	E 	E 	E 						12 = 12	12 = 12	G = 90	
	H 	H 	H 						14 = 14	14 = 14	H = 100	
	K 	K 	K 						16 = 16	16 = 16	J = 110	
	L 	L 	L 						20 = 20	20 = 20	K = 125	
	M 	M 	M 						22 = 22	22 = 22	L = 140	
	O 	O 	O 						25 = 25	25 = 25	M = 150	
	P 	P 	P 						32 = 32	32 = 32	N = 160	
	R 	R 	R 						40 = 40	40 = 40	P = 170	
	S 	S 	S 						50 = 50	50 = 50	Q = 180	
	T 	T 	T 								R = 200	
	V 	V 	V 								S = 250	
	W 	W 	W 								T = 300	
												U = 350
												V = 400
												W = 450
						Y = 500						
						X = ÖZEL Special Sonderform						

**تکنیک تولز**  
ابزار آلات صنعتی، تراشکاری و قالبسازی  
۶۶۷۱۷۲۹ - ۶۶۷۱۱۹۶۷  
تهران، خ امام خمینی، م حسن آباد، پاساژ هشت گنبد، شماره ۱۴



